

LTE to 5G: Cellular and Broadband Innovation

RYSAVY
RESEARCH



This white paper was written for 5G Americas by Rysavy Research (<http://www.rysavy.com>) and utilized a composite of statistical information from multiple resources.



LTE to 5G:
*Cellular and Broadband
Innovation*

Table of Contents

INTRODUCTION	5
BROADBAND TRANSFORMATION	8
EXPLODING DEMAND	12
Application Innovation.....	12
Internet of Things.....	13
Video Streaming.....	13
Cloud Computing.....	14
5G Data Drivers.....	14
Global Mobile Adoption.....	15
ALMOST AT 5G	19
Expanding Use Cases.....	19
1G to 5G Evolution.....	21
4G LTE Advances.....	24
5G Use Cases (ITU and 3GPP).....	28
5G Technical Objectives.....	30
5G Concepts and Architectures.....	31
5G New Radio (NR).....	34
Expected 5G Performance.....	36
Release 15 Non-Standalone and Standalone Options.....	36
5G Schedule.....	Error! Bookmark not defined.
5G Core Network.....	38
5G Device Availability.....	38
mmWave.....	38
Network Slicing.....	40
Information-Centric Networking.....	41
3GPP Releases.....	42
SUPPORTING TECHNOLOGIES AND ARCHITECTURES	45
Multiple Cell Types.....	45
Small Cells and Heterogeneous Networks.....	46
Neutral-Host Small Cells.....	49
Unlicensed Spectrum Integration.....	49
Internet of Things and Machine-to-Machine.....	53
Smart Antennas and MIMO.....	55
Virtualization.....	56
Multi-Access Edge Computing.....	58
Multicast and Broadcast.....	58
Remote SIM Provisioning.....	58
VOLTE, RCS, WEBRTC, AND WI-FI CALLING	60
Voice Support and VoLTE.....	60
Rich Communications Suite.....	60
WebRTC.....	61
Wi-Fi Calling.....	62
PUBLIC SAFETY	63
LTE Features for Public Safety.....	63
Deployment Approaches.....	65

Device Considerations for Public Safety	66
EXPANDING CAPACITY	68
SPECTRUM DEVELOPMENTS.....	72
AWS-3.....	74
Broadcast Incentive Auction (600 MHz)	74
3550 to 3700 MHz "Small-Cell" Band.....	75
2.5 GHz Band	76
5G Bands.....	76
Harmonization.....	78
Unlicensed Spectrum.....	80
Spectrum Sharing.....	81
CONCLUSION.....	85
APPENDIX: TECHNOLOGY DETAILS	86
3GPP Releases.....	86
Data Throughput Comparison.....	88
Latency Comparison.....	94
Spectral Efficiency.....	95
Data Consumed by Streaming and Virtual Reality	102
Spectrum Bands	104
5G	107
Architecture	107
Architecture Options	108
LTE-NR Coexistence.....	110
Integrated Access and Backhaul	113
Performance	114
LTE and LTE-Advanced	117
LTE-Advanced Terminology.....	118
OFDMA and Scheduling	119
LTE Smart Antennas	121
LTE-Advanced Antenna Technologies	125
Carrier Aggregation	129
Coordinated Multi Point (CoMP)	133
Cellular V2X Communications.....	135
User-Plane Congestion Management (UPCON)	136
Network-Assisted Interference Cancellation and Suppression (NAICS).....	136
Multi-User Superposition Transmission (MUST).....	136
IPv4/IPv6	137
TDD Harmonization.....	137
SMS in LTE	138
User Equipment Categories.....	138
LTE-Advanced Relays.....	139
Proximity Services (Device-to-Device).....	140
LTE Throughput.....	141
VoLTE and RCS	148
LTE Ultra-Reliable and Low-Latency Communications	153
Evolved Packet Core (EPC).....	153
Heterogeneous Networks and Small Cells.....	156
Enhanced Inter-cell Interference Coordination	160
Dual Connectivity	165

Internet of Things and Machine-to-Machine.....	167
Cloud Radio-Access Network (RAN) and Network Virtualization.....	168
Unlicensed Spectrum Integration.....	173
Release 6 I-WLAN.....	174
Release 8 Dual Stack Mobile IPv6 and Proxy Mobile IPv6.....	174
Release 11 S2a-based Mobility over GTP.....	174
Multipath TCP.....	175
ANDSF.....	175
Bidirectional Offloading Challenges.....	176
Other Integration Technologies (SIPTO, LIPA, IFOM, MAPCON).....	178
Hotspot 2.0.....	178
Self-Organizing Networks (SON).....	180
IP Multimedia Subsystem (IMS).....	182
Broadcast/Multicast Services.....	183
Backhaul.....	185
UMTS-HSPA.....	186
HSDPA.....	187
HSUPA.....	190
Evolution of HSPA (HSPA+).....	191
Advanced Receivers.....	191
MIMO.....	192
Continuous Packet Connectivity.....	193
Higher Order Modulation.....	193
Multi-Carrier HSPA.....	193
Downlink Multiflow Transmission.....	194
HSPA+ Throughput Rates.....	195
UMTS TDD and TD-SCDMA.....	199
EDGE/EGPRS.....	200
ABBREVIATIONS AND ACRONYMS.....	204
ADDITIONAL INFORMATION.....	214

Copyright ©2017 Rysavy Research, LLC. All rights reserved. <http://www.rysavy.com>

Introduction

Mobile computing with wireless communications has already changed how people socialize and how companies do business. Yet, we are still in the nascent stages of the transformation that ubiquitous connectivity is enabling. Early examples of this exciting future include virtual and augmented reality, autonomous driving, smart cities, wearable computers, and connected devices throughout our environment. While no one can predict the full extent of innovation that the new global broadband fabric, aided by complementary innovations such as AI, will unleash, one thing is certain: We are rushing toward an extraordinary time.

The step from 3G to 4G was dramatic, and industry advances occurring now in LTE and 5G will be even greater. Standards bodies are standardizing 5G, a process that will continue through the 2020 timeframe, with ongoing enhancements continuing during the next decade. Some operators are deploying pre-standard 5G in trials this year, and initial standards-based networks could be deployed as early as 2019. 5G will not replace LTE; in most deployments, the two technologies will be tightly integrated and co-exist through at least the late-2020s.

Many of the capabilities that will make 5G so effective are appearing in advanced forms of LTE. With carrier aggregation, for example, operators have not only harnessed the potential of their spectrum holdings to augment capacity and performance, but the technology is also the foundation for entirely new capabilities, such as operating LTE in unlicensed bands.

The computing power of today's handheld computers rivals that of past mainframe computers, powering intuitive operating systems and millions of applications. Coupled with affordable mobile broadband connectivity, these devices provide such unprecedented utility that billions of people are using them.

With long term growth in smartphone and other mobile device use limited by population, innovators are increasingly turning their attention to the Internet of Things (IoT), which already encompasses a wide array of applications. Enhancements to LTE, followed by 5G IoT capabilities, will connect wearable computers, sensors, and other devices, leading to better health, economic gains, and other advantages. 5G addresses not only IoT deployments on a massive scale but also enables applications previously not possible that depend on ultra-reliable and low-latency communications, sometimes called "mission-critical applications." Although a far more fragmented market than smartphones, the benefits will be so great that the realization of IoT on a massive scale is inevitable.

Regulatory policies are striving to keep pace, addressing complex issues that include how best to allocate and manage new spectrum, network neutrality, and privacy. Policy decisions will have a major impact on the evolution of mobile broadband.

These are exciting times for both people working in the industry and those who use the technology—which today is nearly everybody. This paper attempts to capture the scope of what the industry is developing, beginning with Table 1, which summarizes some of the most important advances.

Table 1: Most Important Wireless Industry Developments in 2017

Development	Summary
<p>5G Research and Development Accelerates</p>	<p>5G, in early stages of definition through global efforts and many proposed technical approaches, could be deployed in non-standalone versions as early as 2019. Deployment will continue through 2030. Some operators will deploy pre-standard networks for fixed-wireless access in 2017.</p> <p>5G is being designed to integrate with LTE, and some 5G features may be implemented as LTE-Advanced Pro extensions prior to full 5G availability.</p>
<p>5G New Radio (NR) Being Defined</p>	<p>Key aspects of the 5G NR have been determined, such as radio channel widths and use of OFDMA. The first version, specified in Release 15, will support low-latency, beam-based channels, massive Multiple Input Multiple Output (MIMO) with large numbers of controllable antenna elements, scalable-width subchannels, carrier aggregation, Cloud Radio-Access Network (RAN) capability, and dynamic co-existence with LTE.</p>
<p>LTE Has Become the Global Cellular Standard</p>	<p>A previously fragmented wireless industry has consolidated globally on LTE.</p> <p>LTE is being deployed more quickly than any previous-generation wireless technology.</p>
<p>LTE-Advanced Provides Dramatic Advantages</p>	<p>LTE capabilities continue to improve with carrier aggregation, 1 Gbps peak throughputs, higher-order MIMO, multiple methods for expanding capacity in unlicensed spectrum, new IoT capabilities, vehicle-based communications, small-cell support including Enhanced Inter-Cell Interference Coordination (eICIC), lower latency, Self-Organizing Network (SON) capabilities and Enhanced Coordinated Multi Point (eCoMP).</p>
<p>Internet of Things Poised for Massive Adoption</p>	<p>IoT, evolving from machine-to-machine (M2M) communications, is seeing rapid adoption, with tens of billions of new connected devices expected over the next decade.</p> <p>Drivers include improved LTE support, such as low-cost and low-power modems, enhanced coverage, higher capacity, and service-layer standardization, such as oneM2M.</p>
<p>Unlicensed Spectrum Becomes More Tightly Integrated with Cellular</p>	<p>The industry has developed increasingly sophisticated means for integrating Wi-Fi and cellular networks, such as LTE-WLAN Aggregation (LWA) and LTE-WLAN Aggregation with IPsec Tunnel (LWIP), making the user experience ever more seamless.</p> <p>The industry has also developed and is now deploying versions of LTE that can operate in unlicensed spectrum, such as LTE-Unlicensed (LTE-U), LTE-Licensed Assisted Access (LTE-LAA), and</p>

Development	Summary
	MulteFire. Cellular and Wi-Fi industry members are successfully collaborating to ensure fair spectrum co-existence.
Spectrum Still Precious	<p>Spectrum in general, and in particular licensed spectrum, remains a precious commodity for the industry.</p> <p>Recently added spectrum in the United States includes the 600 MHz band, auctioned in 2017, and the 3.5 GHz Citizens Broadband Radio Service (CBRS) “small-cell” band, which could see initial deployments in 2018.</p> <p>5G spectrum will include bands above 6 GHz, including “mmWave” (30 GHz to 100 GHz), with the potential of ten times (or more) as much spectrum as is currently available for cellular. Radio channels of 200 MHz and 400 MHz, and even wider in the future, will enable multi-Gbps peak throughput.</p>
Small Cells Take Baby Steps, Preparing to Stride	<p>Operators have begun installing small cells, which now number in the tens of thousands. Eventually, hundreds of thousands if not millions of small cells will lead to massive increases in capacity.</p> <p>The industry is slowly overcoming challenges that include restrictive regulations, site acquisition, self-organization, interference management, power, and backhaul.</p>
Network Function Virtualization (NFV) Emerges	<p>Network function virtualization (NFV) and software-defined networking (SDN) tools and architectures are enabling operators to reduce network costs, simplify deployment of new services, reduce deployment time, and scale their networks.</p> <p>Some operators are also virtualizing the radio-access network, as well as pursuing a related development called cloud radio-access network (cloud RAN). NFV and cloud RAN will be integral components of 5G.</p>

The main part of this paper covers the transformation of broadband, exploding demand for wireless services, the path to 5G including planned and expected capabilities, new LTE innovations, supporting technologies and architectures, voice over LTE (VoLTE), Wi-Fi Calling, LTE for public safety, options to expand capacity, and spectrum developments.

The appendix delves into more technical aspects of the following topics: 3GPP Releases, Data Throughput, latency, 5G, LTE, LTE-Advanced, LTE-Advanced Pro, HetNets and small cells, IoT, cloud RANs, Unlicensed Spectrum Integration, self-organizing networks, the IP Multimedia Subsystem, broadcast/multicast services, backhaul, UMTS/WCDMA,¹ HSPA, HSPA+, UMTS TDD, and EDGE/EGPRS.

¹ Although many use the terms “UMTS” and “WCDMA” interchangeably, in this paper “WCDMA” refers to the radio interface technology used within UMTS, and “UMTS” refers to the complete system. HSPA is an enhancement to WCDMA.

Broadband Transformation

Broadband networks rely on a fiber core with various access technologies, such as fiber to the premises, coaxial cable, digital subscriber line (DSL), or wireless connections. LTE provides a broadband experience, but capacity limitations prevent it from being the only broadband connection for most users. As a result, a majority of consumers in developed countries have both mobile broadband and fixed broadband accounts.

Two developments will transform the current situation:

1. **Fiber Densification.** Multiple companies are investing to extend the reach of fiber, decreasing the distance from the fiber network to the end node.
2. **5G Standardization and Deployment.** As 5G mmWave technology, including massive MIMO and beamforming, becomes commoditized, it will increasingly be a viable alternative to fixed-access technologies such as coaxial, DSL, and even fiber connections. 5G commercial services will enable a new innovation cycle. The ability to create new applications and services with fewer limitations will take the connected society to a new level.

Consequently, the companies that provide broadband service may change, and eventually, fixed and mobile broadband services may converge. For a more detailed discussion of trends in broadband, including the disruptive role of mmWave, refer to the 2017 Datacomm Research and Rysavy Research report, *Broadband Disruption: How 5G Will Reshape the Competitive Landscape*.²

As shown in Figure 1, the emerging broadband network is one with denser fiber and competing access technologies in which wireless connectivity plays a larger role.

² Details at <https://datacommresearch.com/reports-broadband/>.

Figure 1: Fiber Densification with Multiple Access Technologies, including mmWave

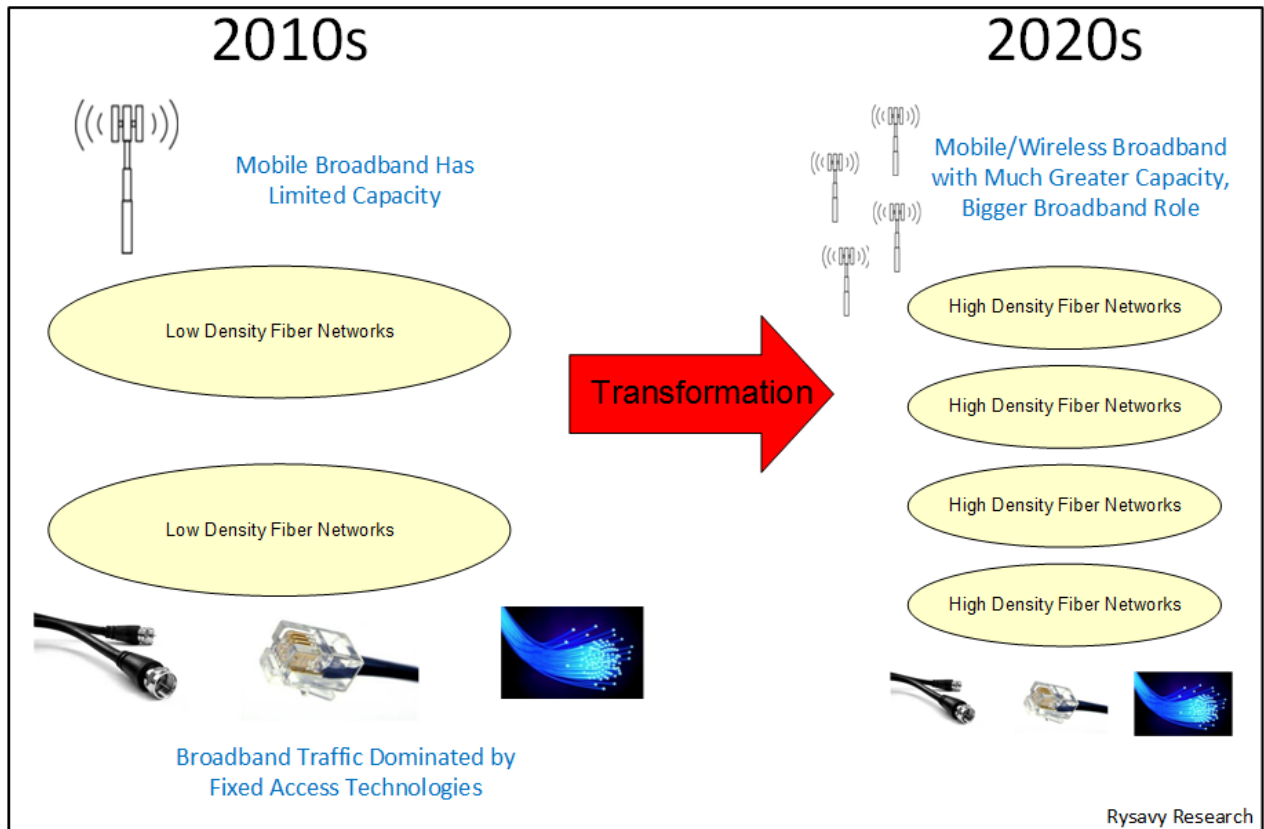

Many elements are interacting to transform mobile broadband, but the factors playing the most important roles are emerging capabilities for IoT, radio advances granting access to far more spectrum, small cells, new network architectures that leverage network function virtualization and software-defined networking, and new means to employ unlicensed spectrum. Except for access to high-band spectrum, a 5G objective, these advances apply to both LTE and 5G.

Figure 2: Fundamental Mobile Broadband Transformational Elements

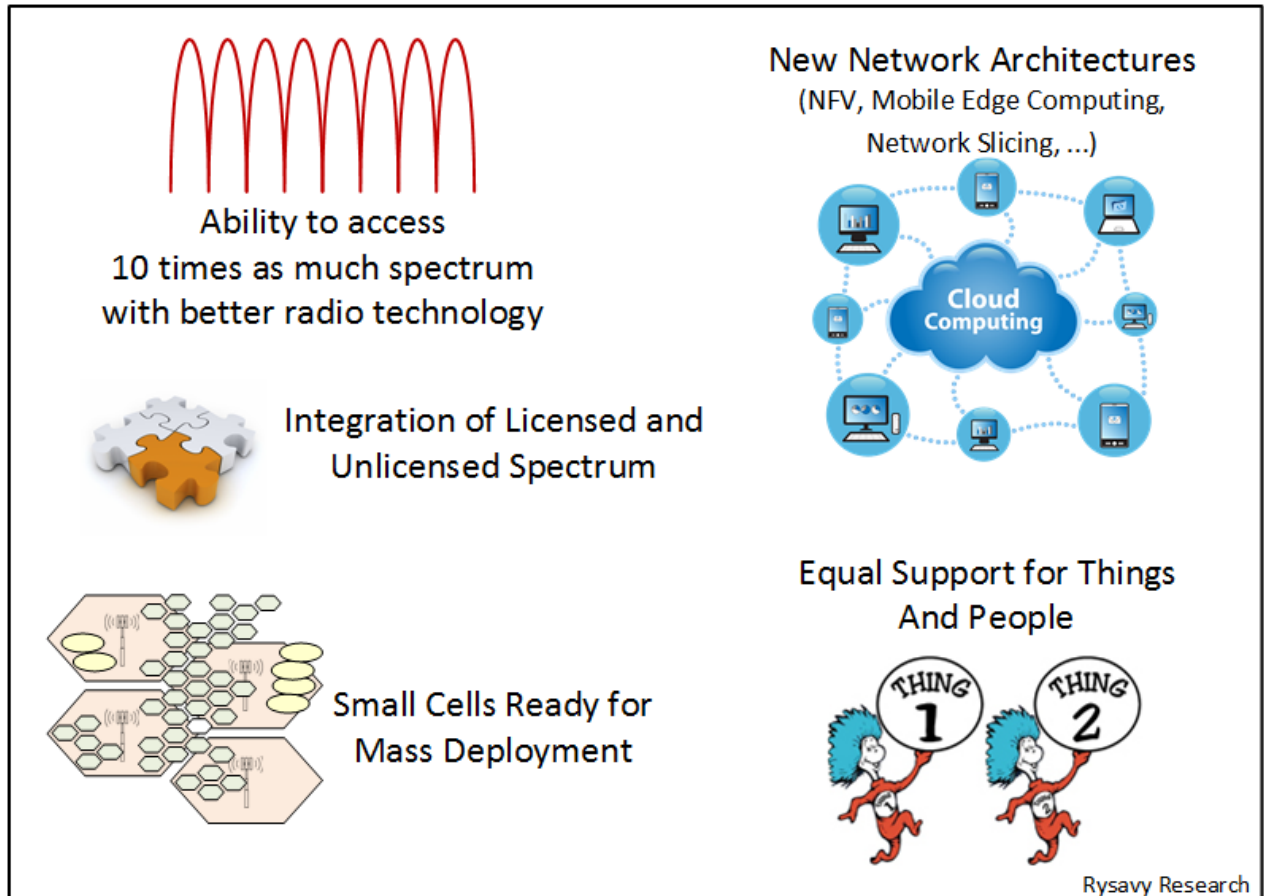

In the past, developers used modems and networks designed for human communication for machine-type applications. But now, new modes of network operation, initially in LTE then enhanced further in 5G, will cater to the unique needs of a wide variety of machine applications, addressing low-cost, long battery life, long communications range, and a wide variety of throughputs. For instance, some IoT applications need only low-throughput communications, some sending only a small number of bits per day.

As for spectrum, throughout radio history, technology has climbed up a ladder to use higher frequencies. What were called “ultra-high frequencies” when made available for television are now considered low-band frequencies for cellular. Frequencies above 6 GHz, particularly mmWave frequencies, are the new frontier. Networks will ultimately take advantage of ten times as much spectrum as they use now, and likely even more over time. Although challenging to use because of propagation limitations and higher penetration loss, massive MIMO, beam steering, beam tracking, dual connectivity, carrier aggregation, small-cell architectures with self-backhauling, and other methods will help mitigate the challenges at these frequencies. The result: massive increases in capacity in localized areas.

In addition to accessing higher bands, cellular technologies are integrating unlicensed spectrum more efficiently, using technologies such as LTE-U, LAA, MulteFire, LWA, and LWIP. This integration will immediately augment small-cell capacity, improving the business case for small cells.

Small cells, on the roadmap for many years but held back by implementation difficulties, such as backhaul, are on the verge of large scale deployment, leading ultimately to densities as high as ten small cells or more for every macro cell. Paving the way are better wireless backhaul solutions, neutral-host capabilities enabled by new technologies, and soon, access to mmWave bands.

Facilitating the capabilities listed above, networks are becoming programmable. Using a distributed, software-enabled network based on virtualization and new architectural approaches such as Multi-access Edge Computing (MEC) and network slicing, operators and third parties will be able to deploy new services and applications more rapidly, and in a more scalable fashion. Centralizing RAN signal processing will also play a huge role; depending on the deployment scenario, such centralization will increase RAN efficiency and decrease deployment cost.

This paper lists the dozens of other innovations also fueling mobile and cellular technology transformation. Together, these transformed networks will mean that for millions, and ultimately billions, of people, wireless connections will be the only connections that they need. These networks will also provide the foundation for entire new industries, ones not yet even conceived.

Exploding Demand

Two technology trajectories have created critical mass: handheld computing and fast wireless connections. This combined computing and communications platform inspires the innovation that has produced millions of mobile applications.

IoT is a third trajectory. LTE, and eventually 5G, will connect tens of billions of devices. And fixed-wireless access could be a fourth. 5G, with expected network capacity a hundred times greater than 4G networks, will make wireless connections not only a viable substitute for wireline broadband connections for tens of millions of users over the next ten years, but make that broadband connection the only connection that many users need.

Figure 3: Exploding Demand from Critical Mass of Factors

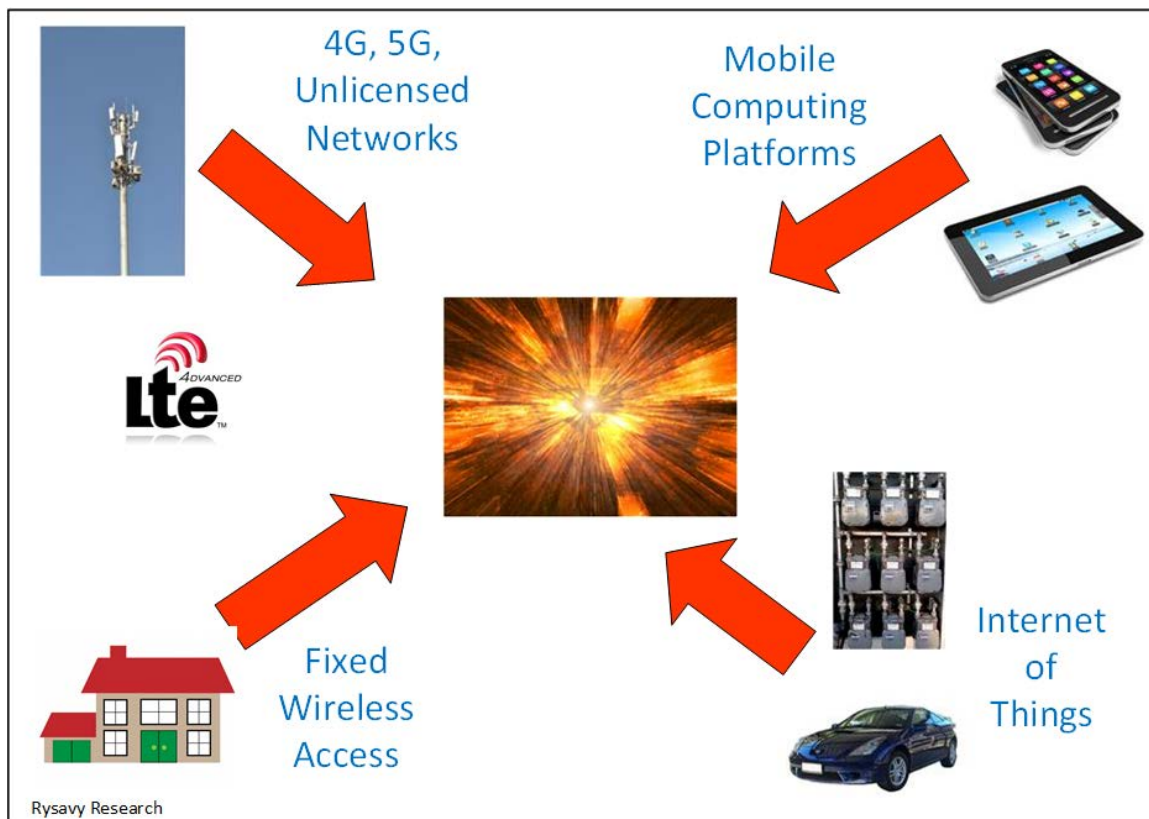

This section analyzes some of these demand factors.

Application Innovation

When planning 4G network technology, who could have predicted applications such as Uber and Lyft, which combine location information with mapping and online payment and are now disrupting the taxi industry and even challenging notions of private vehicle ownership? While some applications of new technology can be predicted, many cannot.

More efficient technology not only addresses escalating demand, it also provides higher performance, thus encouraging new usage models and further increasing demand.

Today's smartphones and tablets, dominated by the iOS and Android ecosystems, in combination with sophisticated cloud-based services, provide a stable, well-defined application environment, allowing developers to target billions of users. Developers have rich platform-specific development tools; web-based tools such as HTML5; application programming interfaces (APIs) for mobile-specific functions, such as WebRTC (Web Real-Time Communications); and cloud-based services for applications and application services, such as notifications, IoT support, and mobile-commerce.

Of concern to some companies in the wireless industry, however, are current network neutrality rules that could possibly hamper innovation. By restricting prioritization, for example, the rules seem to fail to recognize that traffic streams from different applications have inherently different quality of service requirements.³

Internet of Things

Current M2M and Internet of Things applications include vehicle infotainment, connected healthcare, transportation and logistics, connected cars, home security and automation, manufacturing, construction and heavy equipment, energy management, video surveillance, environmental monitoring, smart buildings, wearable computing, object tracking, and digital signage. Municipalities, evaluating the concept of "smart cities," are exploring how to optimize pedestrian and vehicular traffic, connect utility meters, and deploy trash containers that can report when they need emptying.

Although promising, the IoT market is also challenging, with varying communications requirements, long installation lifetimes, power demands that challenge current battery technology, cost sensitivity, security and data privacy concerns, unsuitability of conventional networking protocols for some applications, and other factors that developers must address. Consequently, the IoT opportunity is not uniform; it will eventually comprise thousands of markets. Success will occur one sector at a time, with advances in one area providing building blocks for the next.

Cloud-based support platforms and standardized interfaces are essential for development and deployment of IoT applications. For example, oneM2M has developed a service-layer that can be embedded in hardware and software to simplify communications with application servers.⁴

To address the IoT opportunity, 3GPP is defining progressive LTE refinements that will occur over multiple 3GPP releases. These refinements include low-cost modules that approach 2G module pricing and enable multi-year battery life. See the section "Internet of Things and Machine-to-Machine" in the appendix for more details.

Video Streaming

Video represents the greatest usage of data on smartphones. Just an hour a day of mobile video at 1.0 Mbps throughput, common with YouTube or Netflix, consumes 13.5 GB per month. Many streams, now available in high-definition (HD), consume even more data.

³ For further discussion, see Rysavy Research, *How "Title II" Net Neutrality Undermines 5G*, April 19, 2017. Available at <http://www.rysavy.com/Articles/2017-04-How-Title-II-Net-Neutrality-Undermines-5G.pdf>. Also see *How Wireless is Different – Considerations for the Open Internet Rulemaking*, September 12, 2014. Available at <http://www.rysavy.com/Articles/2014-09-Wireless-Open-Internet.pdf>.

⁴ OneM2M home page: <http://onem2m.org/>.

See the Appendix section “Data Consumed by Video” for a quantification of data consumed by video for multiple usage scenarios.

An increasing number of video applications adapt their streaming rates based on available bandwidth. By doing so, they can continue to operate even when throughput rates drop. Conversely, they take advantage of higher available bandwidth to present video at higher resolution. Fortunately, application developers are becoming sensitive to bandwidth constraints and are offering options for users to reduce consumption.

Nevertheless, video can consume so much data that cutting the broadband cord at the same time as the television cord is not possible for most consumers. With 5G’s massive increase in capacity, however, an increasing percentage of users will use wireless connections as their only broadband connections, including for all their entertainment needs.

Cloud Computing

Cloud computing inherently increases data consumption because it requires communications for all operations. Examples include data synchronization and backup, cloud-based applications (such as email, word processing, and spreadsheets), automatic photo uploads, and music and video streaming.

5G Data Drivers

Futurists can predict some 5G applications, but many others will arise as industries evolve or come into existence to take advantage of new network capabilities. Some potential applications of 5G include:

- ❑ Ultra-high-definition, such as 4K and 8K, and 3D video.
- ❑ Augmented and immersive virtual reality. Ultra-high-fidelity virtual reality can consume 50 times the bandwidth of a high-definition video stream.
- ❑ Realization of the tactile internet—real-time, immediate sensing and control, enabling a vast array of new applications.
- ❑ Automotive, including autonomous vehicles, driver-assistance systems, vehicular internet, infotainment, inter-vehicle information exchange, and vehicle pre-crash sensing and mitigation.
- ❑ Monitoring of critical infrastructure, such as transmission lines, using long battery life and low-latency sensors.
- ❑ Smart transportation using data from vehicles, road sensors, and cameras to optimize traffic flow.
- ❑ Mobile health and telemedicine systems that rely on ready availability of high-resolution and detailed medical records, imaging, and diagnostic video.
- ❑ Public safety, including broadband data and mission-critical voice.
- ❑ Sports and fitness enhancement through biometric sensing, real-time monitoring, and data analysis.
- ❑ Fixed broadband replacement.

Some of these applications are already being addressed by 4G, but 5G's lower costs, higher throughputs, and lower latency will hasten realization of their potential.

Specific industries expected to take advantage of 5G include manufacturing, healthcare, media and entertainment, financial services, public safety, automotive, public transport, and energy utilities.⁵

Global Mobile Adoption

Figure 4 shows the often-cited Cisco projection of global mobile data consumption through 2021, measured in exabytes (billion gigabytes) per month, demonstrating traffic growing at a compound annual rate of 47%.

Figure 4: Global Mobile Data 2016 to 2021⁶

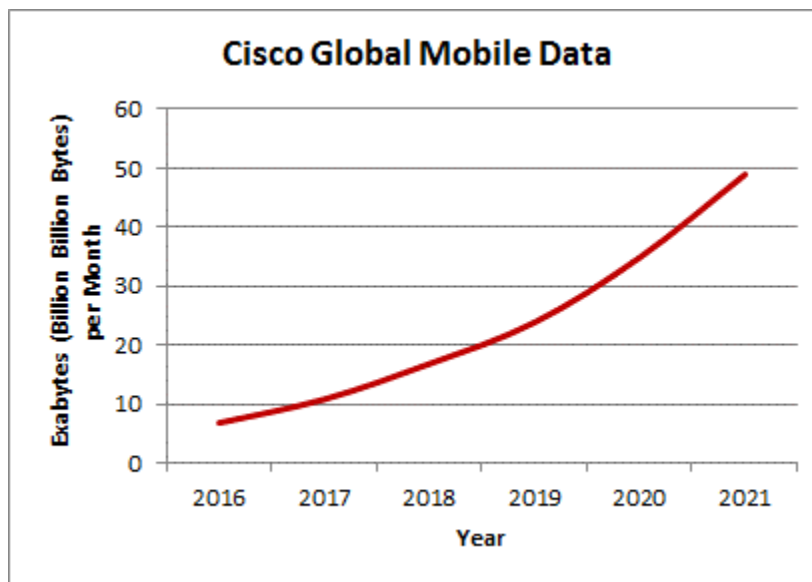

Figure 5 shows another data projection, predicting 45% annual growth in data for the 2016-to-2022 period, resulting in eight-fold growth.

⁵ For further insight, refer to the Ericsson white paper, *The 5G Business Potential*, February 2017. Available at <https://www.ericsson.com/en/networks/insights/the-5g-business-potential>.

⁶ Cisco, *Cisco Visual Networking Index: Global Mobile Data Traffic Forecast Update, 2016-2021*, February 2017.

Figure 5: Global Mobile Voice and Data (Exabytes/Month) 2012 to 2022⁷

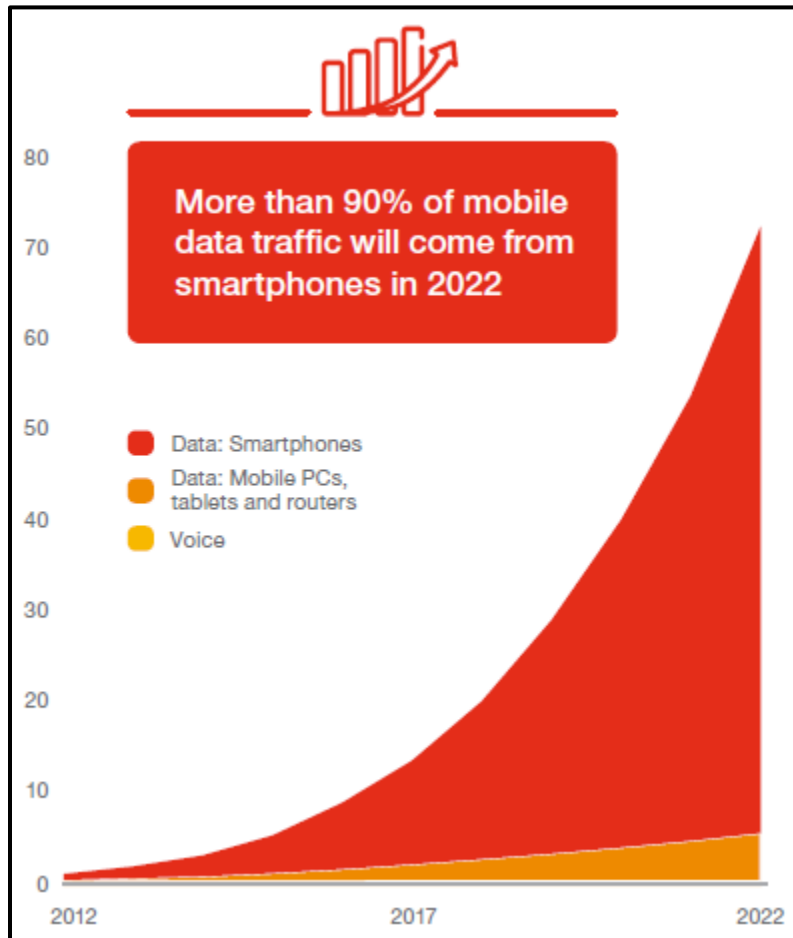
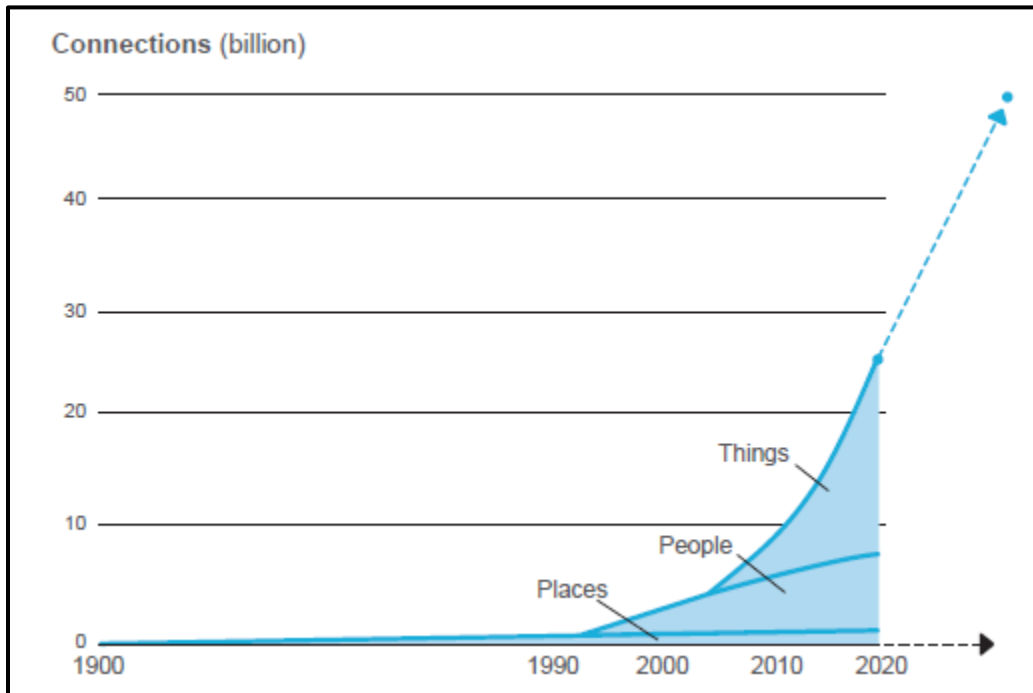

Figure 6 shows how the Internet of Things will drive far more connections than are launched by people.

⁷ Ericsson, *Ericsson Mobility Report*, June 2017.

Figure 6: Connections of Places Versus People Versus Things⁸



In June 2017, more than 7.56 billion GSM-HSPA-LTE connections were in effect⁹—greater than the world’s 7.40 billion population.¹⁰ By the end of 2022, the global mobile broadband market is expected to include nearly 9.4 billion subscribers, with 9.3 billion using 3GPP technologies, representing more than 99% market share.¹¹

LTE has experienced faster deployment than any mobile technology ever developed. All major U.S. operators now offer nationwide LTE coverage. LTE has also been chosen by U.S. national public-safety organizations as their broadband technology of choice.

As shown in Figure 7, 2G GSM has peaked and is now declining, as is CDMA. Both HSPA and LTE subscriptions will continue to rise through the rest of the decade.

⁸ Ericsson, *IoT Security*, February 2017, available at <https://www.ericsson.com/assets/local/publications/white-papers/wp-iot-security-february-2017.pdf>.

⁹ Ovum, July 2017.

¹⁰ U.S. Census Bureau, “U.S. and World Population Clock,” <http://www.census.gov/popclock/>, accessed July 18, 2017.

¹¹ Ovum, July 2017. Note that the 2018 mobile broadband market figures include GSM/EDGE, because most GSM networks are likely to include Evolved EDGE, which provides mobile broadband capability.

Figure 7: Global Adoption of 2G-4G Technologies 2010 to 2020¹²

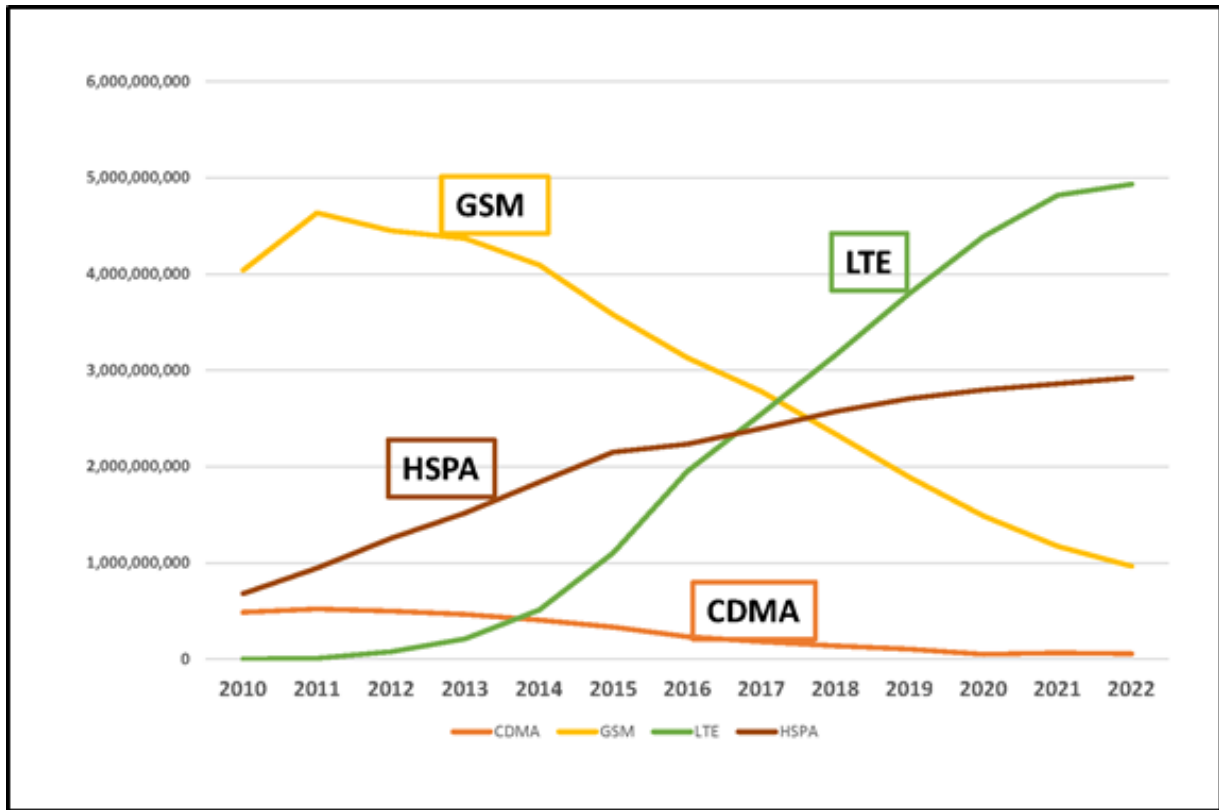

IoT is growing rapidly as well, although connections so far are well below phone-type connections. Cisco projects 3.3 billion IoT connections by 2021, with 6% on 2G cellular, 16% on 3G, and 46% on 4G.¹³

¹² Ovum (WCIS), July 2017.

¹³ Cisco, *Cisco Visual Networking Index: Global Mobile Data Traffic Forecast Update, 2016-2021*, February 2017.

Almost at 5G

With intensive development occurring within 3GPP, the first 5G specification will be completed in early 2018, enabling the first standards-based networks to be deployed in the 2019-2020 timeframe. This section includes expanding use cases, 1G-to-5G evolution, 4G LTE advances, 5G radio and architectures, Information-Centric Networking, phasing of 5G releases, and an overview of 3GPP releases.

Expanding Use Cases

Many wireless technology discussions focus on radio capabilities, but other equally important aspects include use cases, the services built on top of the technology, how different networks integrate with one another, and the topology of the networks. As summarized in Figure 8, these aspects are expanding, making mobile/wireless technology the foundation for other enterprises, including business-process optimization, consumer electronics, M2M, connected devices, and a multitude of vertical industries.

Figure 8: Expanding Use Cases

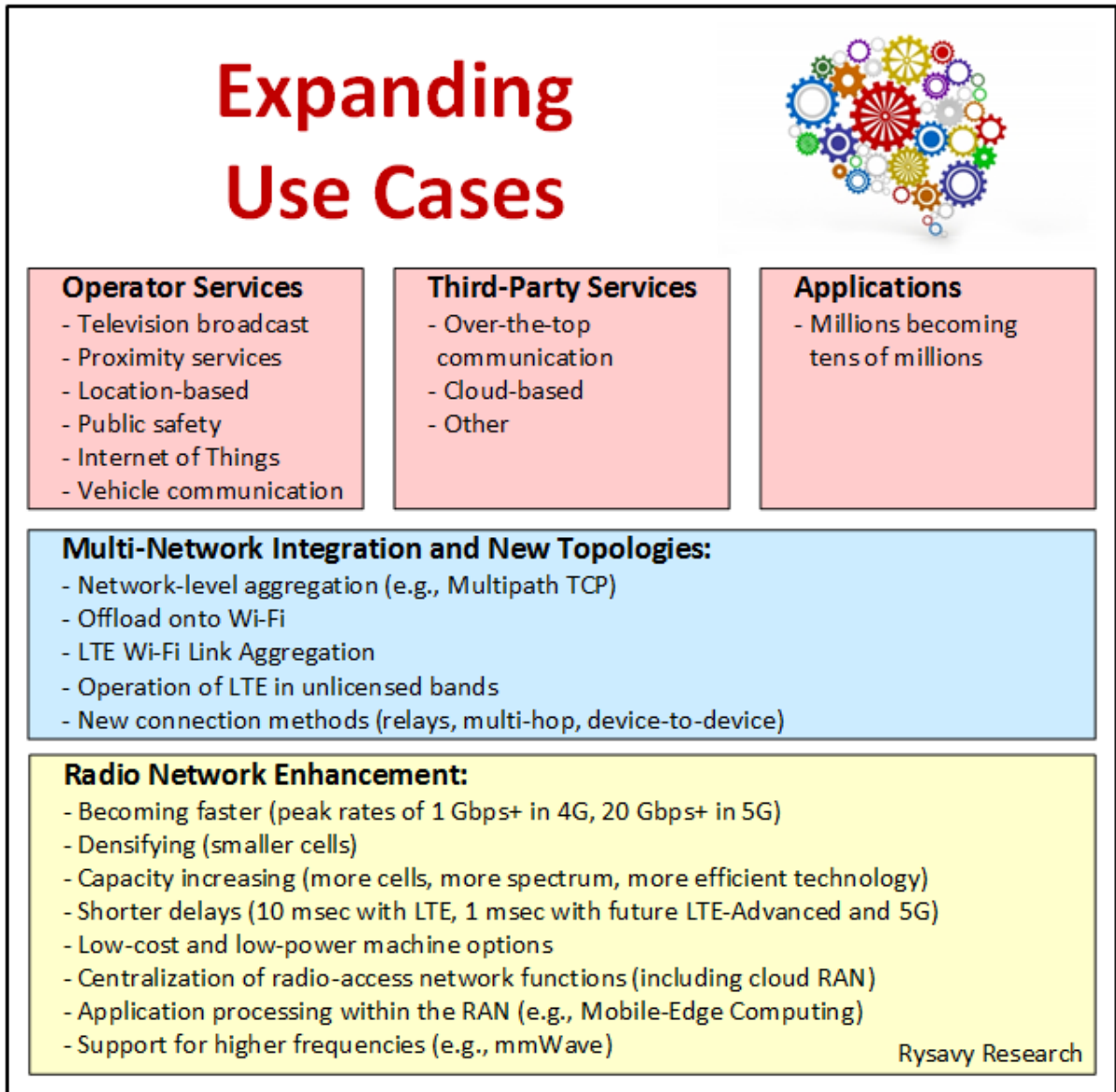

Table 2 summarizes the requirements of the expanding number of use cases that employ wireless technology.

Table 2: Requirements for Different Use Cases¹⁴

Use Cases	Requirements	Desired Value
Autonomous vehicle control	Latency	5 msec
	Availability	99.999 percent
	Reliability	99.999 percent

¹⁴ Ericsson, *5G Systems – Enabling the Transformation of Industry and Society*, January 2017. Available at <https://www.ericsson.com/assets/local/publications/white-papers/wp-5g-systems.pdf>. Adapted from Table 1.

Use Cases	Requirements	Desired Value
Emergency communication	Availability	99.9 percent victim discovery rate
	Energy efficiency	One-week battery life
Factory cell automation	Latency	Down to below 1ms
	Reliability	Down to packet loss of less than 10 ⁻⁹
High-speed train	Traffic density	Downlink (DL): 100Gbps/km ² , uplink (UL): 50 Gbps/km ²
	User throughput	DL: 50Mbps, UL: 25Mbps
	Mobility	500 km/h
	Latency	10ms
Large outdoor event	User throughput	30Mbps
	Traffic density	900Gbps/km ²
	Connection density	Four devices/m ²
Massive IoT	Connection density	1,000,000 devices/km ²
	Availability	99.9 percent coverage
	Energy efficiency	10-year battery life
Remote surgery and examination	Latency	Down to 1ms
	Reliability	99.999 percent
Smart city	User throughput	DL: 300Mbps, UL: 60Mbps
	Traffic density	700 Gbps/km ²
	Connection density	200,000 devices/km ²
Virtual and augmented reality	User throughput	4-28Gbps
	Latency	< 7msec
Broadband to the home	Connection density	4,000 devices/km ²
	Traffic density	60Gbps/km ²

The economic role that wireless technology plays keeps increasing. One study anticipates that in 2035, 5G will enable \$12.3 trillion of global economic output.¹⁵

1G to 5G Evolution

5G is almost upon us; it is a technology that will be constructed from millions of ideas, methods, algorithms, and processes. Just as 4G LTE became available when previous technologies, such as HSPA, could be further improved, 5G enters the stage when the roadmap for LTE has not been exhausted. And just as 2G coexists today with 3G and 4G, 5G will co-exist with previous generations of technology.

For historical context, “1G” refers to analog cellular technologies that became available in the 1980s. “2G” denotes initial digital systems that became available in the 1990s and that introduced services such as short messaging and lower-speed data. 3G requirements were specified by the International Telecommunication Union (ITU) as part of the International Mobile Telephone 2000 (IMT-2000) project, for which significant voice capacity improvement was a focus and digital networks had to provide 144 Kbps of throughput at mobile speeds, 384 Kbps at pedestrian speeds, and 2 Mbps in indoor environments. UMTS-

¹⁵ HIS Economics and HIS Technology, *The 5G Economy: How 5G Technology will contribute to the global economy*, January 2017. Commissioned by Qualcomm Technologies.

HSPA and CDMA2000 are the primary 3G technologies. 3G technologies began to be deployed early last decade.

In 2008, the ITU issued requirements for IMT-Advanced, which many people initially used as a definition of 4G. The focus on 4G was to improve data coverage, capacity, and quality of experience. Requirements included operation in up to-40 MHz radio channels and extremely high Spectral Efficiency. The ITU required peak spectral efficiency of 15 bps/Hz and recommended operation in up-to-100 MHz radio channels, resulting in a theoretical throughput rate of 1.5 Gbps. In 2009 and 2010, the term "4G" became associated with mobile broadband technologies deployed at the time, such as HSPA+, WiMAX, and initial LTE deployments. Today, 4G usually refers to HSPA+ or LTE.

Although the industry is preparing for 5G, LTE capabilities will continue to improve in LTE-Advanced Pro through the rest of the decade. Many of these enhancements will come through incremental network investments. Given the scope of global wireless infrastructure, measured in hundreds of billions of dollars, offering users the most affordable service requires operators to leverage investments they have already made. 5G will eventually play an important role, but it must be timed appropriately so that the jump in capability justifies the new investment.

5G groups researching next generation wireless architecture and requirements include, among others, the International Telecommunication Union (ITU),¹⁶ the European Union's 5G Infrastructure Public-Private-Partnership (5G PPP), which is the framework for several projects, including METIS II (Mobile and wireless communications Enablers for the Twenty-twenty Information Society), and Next Generation Mobile Networks (NGMN). Finally, 5G Americas is actively involved in developing the vision and requirements of 5G for North, Central, and South America. 5G Americas signed an MoU to collaborate with 5G-PPP.¹⁷

The ITU, the standardization group of the United Nations, has set the following standardization timetable in its IMT-2020 project:¹⁸

- ❑ 2016-2017: Definition of technical performance requirements, evaluation criteria and methods, and submission templates.
- ❑ 2018-2019: Submission of proposals.
- ❑ 2019: Evaluation of proposed technologies.
- ❑ 2019 and 2020: Publication of IMT-2020 specifications.

¹⁶ International Telecommunication Union, "Working Party 5D (WP 5D) - IMT Systems," <http://www.itu.int/ITU-R/index.asp?category=study-groups&mlink=rwp5d&lang=en>, accessed May 16, 2017.

¹⁷ 5GPPP, "5G-PPP MoU with 4G Americas," March 2, 2015. <http://5g-ppp.eu/5g-ppp-mou-with-4g-amerericas/>

¹⁸ ITU, "ITU towards 'IMT for 2020 and beyond'," <http://www.itu.int/en/ITU-R/study-groups/rsg5/rwp5d/imt-2020/Pages/default.aspx>, viewed May 16, 2017.

Wireless technology has progressed to the extent that significant new capabilities are inevitable, making 5G a possible alternative to wireline broadband for many subscribers.¹⁹

Table 3 summarizes the generations of wireless technology.

Table 3: 1G to 5G

Generation	Requirements	Comments
1G	No official requirements. Analog technology.	Deployed in the 1980s.
2G	No official requirements. Digital technology.	First digital systems. Deployed in the 1990s. New services such as SMS and low-rate data. Primary technologies include IS-95 CDMA (cdmaOne), IS-136 (D-AMPS), and GSM.
3G	ITU's IMT-2000 required 144 Kbps mobile, 384 Kbps pedestrian, 2 Mbps indoors.	First deployment in 2000. Primary technologies include CDMA2000 1X/EV-DO and UMTS-HSPA. WiMAX.
4G (Initial Technical Designation)	ITU's IMT-Advanced requirements include the ability to operate in up-to-40-MHz radio channels and with very high spectral efficiency.	First deployment in 2010. IEEE 802.16m and LTE-Advanced meet the requirements.
4G (Current Marketing Designation)	Systems that significantly exceed the performance of initial 3G networks. No quantitative requirements.	Today's HSPA+, LTE, and WiMAX networks meet this requirement.
5G	ITU IMT-2020 has defined technical requirements for 5G, and 3GPP is developing specifications.	First standards-based deployments in 2019 and 2020.

The interval between each significant technology platform has been about ten years. Within each platform, however, innovation surges unabated. For example, with 2G technology,

¹⁹ Rysavy Research, "How will 5G compare to fiber, cable or DSL?" Fierce Wireless, May 2014. Available at <http://www.rysavy.com/Articles/2014-05-5G-Comparison-Wireline.pdf>.

EDGE significantly improved data performance compared with initial General Packet Radio Service (GPRS) capabilities. Similarly, HSPA hugely increased data speeds compared with initial 3G capabilities. LTE and LTE-Advanced are also acquiring continual improvements that include faster speeds, greater efficiency, and the ability to aggregate spectrum more flexibly.

Figure 9 presents the timeline of technology generations, including past and future, showing initial deployment, the year of the peak number of subscribers, and decline. Each cellular generation spans multiple decades, with peak adoption occurring some 20 years after initial deployment. 6G deployment in 2030, though highly speculative, is consistent with deployment of previous generations.

Figure 9: Timeline of Cellular Generations

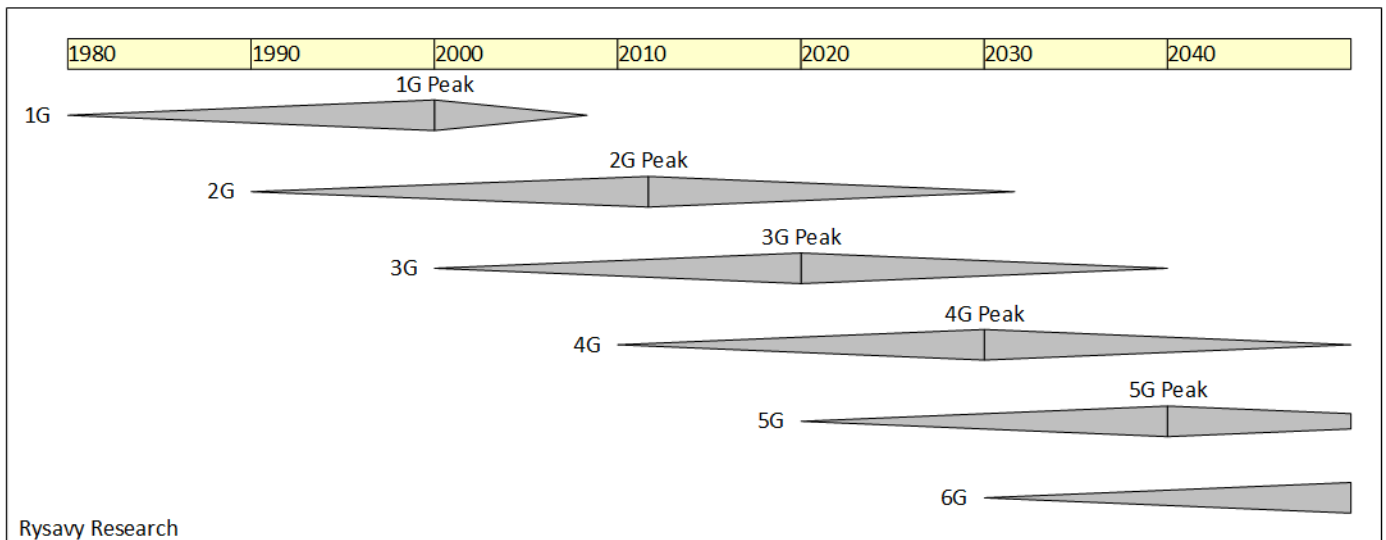

4G LTE Advances

As competitive pressures in the mobile broadband market intensified, and as demand for capacity persistently grew, LTE became the favored 4G solution because of its high data throughputs, low-latency, and high spectral efficiency. Specifically:

- ❑ **Wider Radio Channels.** LTE can be deployed in wide radio channels (for example, 10 MHz or 20 MHz) with carrier aggregation now up to 640 MHz, although inter-band aggregation of four or five carriers (up to 100 MHz) represents a practical upper limit.
- ❑ **Easiest MIMO Deployment.** By using new radios and antennas, LTE facilitates MIMO Deployment, in contrast to the logistical challenges of adding antennas for MIMO to existing legacy technologies. Furthermore, MIMO gains are maximized because all user equipment supports it from the beginning.
- ❑ **Best Latency Performance.** For some applications, low latency (packet traversal delay) is as important as high throughput. With a low transmission time interval (TTI) of 1 millisecond (msec) and a flat architecture (fewer nodes in the core network), LTE has the lowest latency of any cellular technology.

In the same way that 3G coexists with 2G systems in integrated networks, LTE systems co-exist with both 3G and 2G systems, with devices capable of 2G, 3G, and 4G modes.

Beyond radio technology, the Evolved Packet Core (EPC) provides a core architecture that integrates with both legacy GSM-HSPA networks and other wireless technologies, such as CDMA2000 and Wi-Fi. The combination of EPC and LTE is referred to as the Evolved Packet System (EPS).

LTE is available in both Frequency Division Duplex (FDD) and Time Division Duplex (TDD) modes. Many deployments are based on FDD in paired spectrum. The TDD mode, however, is important for deployments in which paired spectrum is unavailable. Instances of TDD deployment include China, Europe at 2.6 GHz, U.S. Broadband Radio Service (BRS) spectrum at 2.6 GHz, and the 3.5 GHz band.

The versions of LTE most widely deployed today are just the first in a series of innovations that will increase performance, efficiency, and capabilities. Enhancements in the 2013 to 2016 period were the ones defined in 3GPP Releases 10, 11, and 12 and are commonly referred to as LTE-Advanced.²⁰ Subsequent releases, including Releases 13 to 15, specify LTE-Advanced Pro.

Keeping in mind that different operators have varying priorities, the following list roughly ranks the most important features of LTE-Advanced and LTE-Advanced Pro for the 2017 to 2020 timeframe:

1. **Carrier Aggregation.** With this capability, already in use, operators can aggregate radio carriers in the same band or across disparate bands to improve throughputs (under light network load), capacity, and efficiency. Carrier aggregation can also combine FDD and TDD and is the basis of LTE-U and LTE-LAA. As examples, in 2015, AT&T aggregated 700 MHz with AWS, and 700 MHz with PCS. T-Mobile aggregated 700 MHz with AWS, and AWS with PCS.²¹ Operators are now deploying three-carrier aggregation and eventually may aggregate four carriers.²² Release 13 introduced support for carrier aggregation of up to 32 carriers, addressing primarily the opportunity to aggregate multiple unlicensed channels. Release 14 specifies interband carrier aggregation for up to five downlink carriers and 2 uplink carriers.
2. **VoLTE.** Initially launched in 2015 and with widespread availability in 2017, VoLTE enables operators to roll out packetized voice for LTE networks, resulting in greater voice capacity and higher voice quality.
3. **Tighter Integration of LTE with Unlicensed Bands.** LTE-U became available for testing in 2016, and 3GPP completed specifications for LAA in Release 13, with deployment expected around 2018. MulteFire, building on LAA, will operate without requiring a licensed carrier anchor. LTE/Wi-Fi Aggregation through LWA and LWIP are other options for operators with large Wi-Fi deployments.

²⁰ From a strict standards-development point of view, the term “LTE-Advanced” refers to the following features: carrier aggregation, 8X8 downlink MIMO, and 4XN uplink MIMO with N the number of receive antennas in the base station.

²¹ AT&T band combinations are 3GPP Band 13 + Band 4, Band 17 + Band 4, and Band 17 + Band 2. T-Mobile band combinations are Band 12 + Band 4, Band 12 + Band 2, and Band 4 + Band 2.

²² For carrier aggregation to operate, both the network and the device have to support the particular band combination. Legacy devices typically do not support new network aggregation capabilities.

4. **Enhanced Support for IoT.** Release 13 brings Category M1, a low-cost device option, along with Narrowband-IoT (NB-IoT), a version of the LTE radio interface specifically for IoT devices, called Category NB1.
5. **Higher-Order and Full-Dimension MIMO.** Deployments in 2017 use up to 4X4 MIMO. Release 14 specifies a capability called Full-Dimension MIMO, which supports configurations with as many as 32 antennas at the base station. See the section “Smart Antennas and MIMO” and Appendix section “LTE Smart Antennas” for further detail.
6. **Dual Connectivity.** Release 12 introduced the capability to combine carriers from different sectors and/or base stations (i.e. evolved Node Bs [eNBs]) through a feature called Dual Connectivity. Two architectures were defined: one that supports Packet Data Convergence Protocol (PDCP) aggregation between the different eNBs and one that supports separate S1 connections on the user-plane from the different eNBs to the EPC.
7. **256 QAM Downlink and 64 QAM Uplink.** Defined in Release 12 and already deployed in some networks, higher-order modulation increases user throughput rates in favorable radio conditions.
8. **1 Gbps Capability.** Using a combination of 256 QAM modulation, 4X4 MIMO, and aggregation of three carriers, operator networks can now reach 1 Gbps peak speeds. See below for more information.
9. **V2X Communications.** Release 14 specifies vehicle-to-vehicle and vehicle-to-infrastructure communications. See the section “Cellular V2X Communications” for more information.
10. **Coordinated Multi Point.** CoMP (and enhanced CoMP [eCoMP]) is a process by which multiple base stations or cell sectors process a User Equipment (UE) signal simultaneously, or coordinate the transmissions to a UE, improving cell-edge performance and network efficiency. Initial usage will be on the uplink because no user device changes are required. Some networks had implemented this feature in 2017.
11. **HetNet Support.** HetNets integrate macro cells and small cells. A key feature is enhanced inter-cell interference coordination (eICIC), which improves the ability of a macro and a small-cell to use the same spectrum. This approach is valuable when the operator cannot dedicate spectrum to small cells. Operators are currently evaluating eICIC, and at least one operator has deployed it.²³ Further enhanced ICIC (feICIC) introduced in Rel-11 added advanced interference cancellation receivers into devices.
12. **Ultra-Reliable and Low-Latency Communications.** Being specified in Release 15, URLLC in LTE will shorten radio latency to a 1 msec range using a combination of shorter transmission time intervals and faster hybrid automatic repeat request (HARQ) error processing. See the Appendix section “LTE Ultra-Reliable and Low-Latency Communications” for further details.
13. **Self-Organizing Networks.** With SON, networks can automatically configure and optimize themselves, a capability that will be particularly important as small cells begin

²³ Fierce Wireless, “SK Telecom teams with Nokia Networks on eICIC,” January 2015.

to proliferate. Vendor-specific methods are common for 3G networks, and trials are now occurring for 4G LTE standards-based approaches.

Other key features that will become available in the 2016-to-2020 timeframe include full-dimension MIMO, enhanced Multimedia Broadcast/Multicast Services (eMBMS), User-Plane Congestion Management (UPCON), and device-to-device communication (targeted initially at public-safety applications).

The appendix explains these features and quantifies performance gains, and Figure 10 illustrates the transition from LTE to LTE-Advanced and LTE-Advanced Pro, which include these features.

Figure 10: LTE to LTE-Advanced Pro Migration²⁴

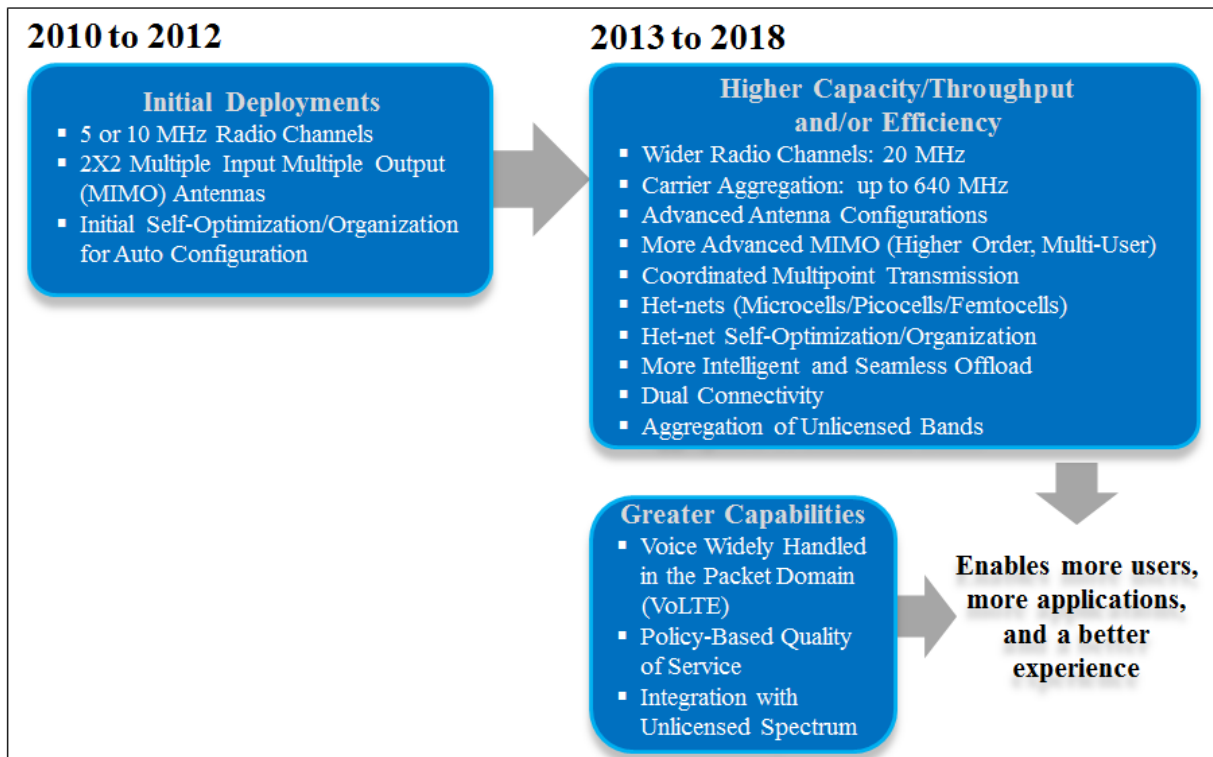
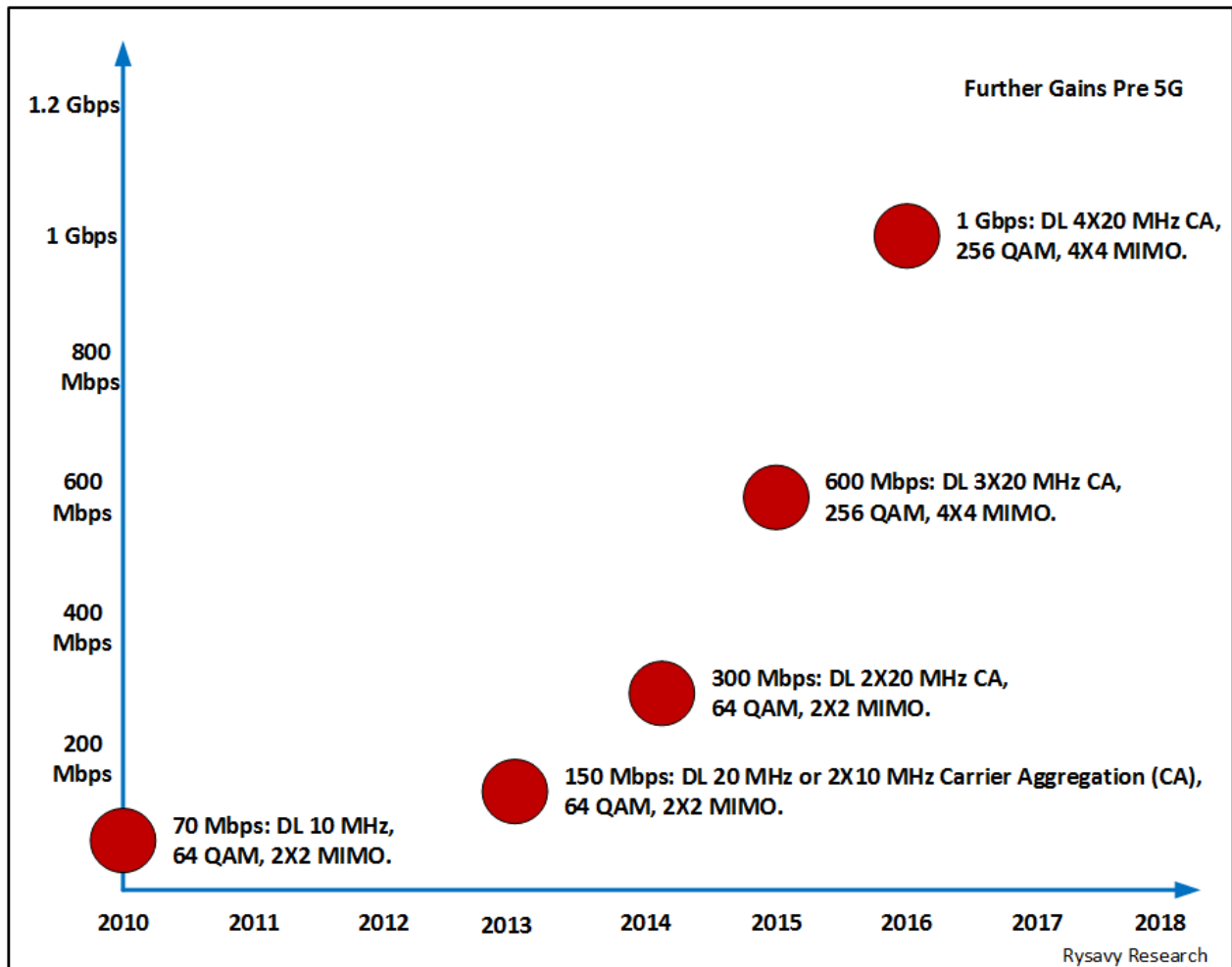

Figure 11 illustrates gains in peak downlink speeds through carrier aggregation, higher-order MIMO, and higher-order modulation.

²⁴ 5G Americas/Rysavy Research

Figure 11: Successive Gains in Peak LTE Downlink Throughput²⁵



5G Use Cases (ITU and 3GPP)

The ITU, in its 5G recommendations, divides use cases into three main categories, as shown in Figure 12.

1. **Enhanced Mobile Broadband (eMBB).** eMBB is the most obvious extension of LTE capability, providing higher speeds for applications such as streaming, Web access, video conferencing, and virtual reality. Highest speeds will occur in small cells with limited movement speed of end users, such as with pedestrians.
2. **Massive Machine-Type Communications (mMTC).** Massive machine-type communications extends LTE Internet of Things capabilities—for example, NB-IoT—

²⁵ Rysavy Research analysis based on information about commercially available chipsets. Not all LTE features are available simultaneously, and thus throughputs do not necessarily scale linearly with items such as bandwidth. See also the following article about achieving gigabit speeds with LTE: Ars Technica, “Qualcomm’s new LTE modem will make gigabit download speeds easier to hit,” February 21, 2017. Available at <https://arstechnica.com/gadgets/2017/02/qualcomms-new-lte-modem-will-make-gigabit-download-speeds-easier-to-hit/#p3>.

to support huge numbers of devices with lower costs, enhanced coverage, and long battery life. As shown in the ITU objectives, below, 5G will support ten times as many devices in an area as LTE.

- 3. Ultra-Reliable and Low Latency Communications (URLLC).** Of the three categories, URLLC enables wireless applications never before possible. Driven by high dependability and extremely short network traversal time, URLLC, also referred to as “mission-critical” communications, will enable industrial automation, drone control, new medical applications, and autonomous vehicles. These types of applications are potentially the ones that will deliver the greatest societal benefits, yet unfortunately, at least in the United States, they could possibly be undermined by current network neutrality regulations. This category is also referred to as critical machine-type communications (cMTC).

Figure 12: ITU Use Case Model²⁶

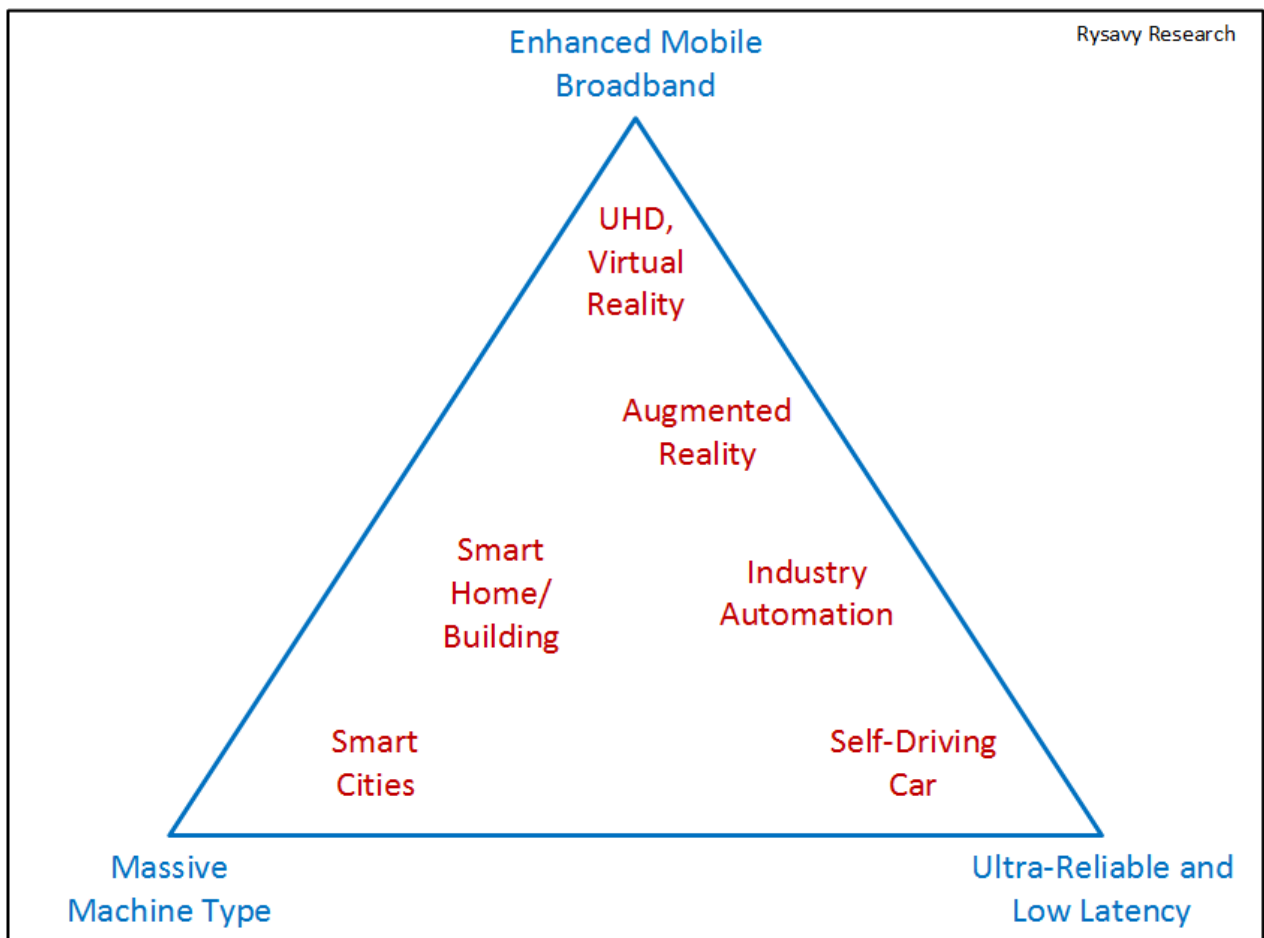

²⁶ For background, see ITU, *IMT Vision – Framework and overall objectives of the future development of IMT for 2020 and beyond*, Recommendation ITU-R M.2083-0, Sep. 2015.

3GPP, in studying 5G, has methodically identified multiple specific use cases in a project called “SMARTER,” which are consistent with ITU’s model.²⁷ 3GPP’s service dimensions include:

- ❑ Massive Internet of Things (eHealth, wearables, eCity, eFarm).
- ❑ Critical Communications (e.g., vehicles, drones, industry robots).
- ❑ Enhanced Mobile Broadband (e.g., augmented reality, virtual reality, ultra-high definition).
- ❑ Network Operation (e.g., network slicing, connectivity/routing, migration/interworking).

Using small cells and mmWave radio channels, a 5G network built for capacity will deliver 1 Tbps/km² or higher, enabling 5G to compete with wireline broadband services.²⁸

5G Technical Objectives

Table 4 shows the ITU’s objectives for IMT-2020 (5G) relative to IMT-Advanced (4G).

Table 4: ITU Objectives for IMT-2020 compared with IMT-Advanced²⁹

	IMT-Advanced	IMT-2020
Peak Data Rate	DL: 1 Gbps UL: 0.05 Gbps	DL: 20 Gbps UL: 10 Gbps
User Experienced Data Rate	10 Mbps	100 Mbps ³⁰
Peak Spectral Efficiency	DL: 15 bps/Hz UL: 6.75 bps/Hz	DL: 30 bps/Hz UL: 15 bps/Hz
Average Spectral Efficiency		DL eMBB indoor: 9 bps/Hz DL eMBB urban: 7.8 bps/Hz DL eMBB rural: 3.3 bps/Hz UL eMBB indoor: 6.75 bps/Hz UL eMBB urban: 5.4 bps/Hz UL eMBB rural: 1.6 bps/Hz

²⁷ 3GPP TR22.891, *Feasibility Study on New Services and Markets Technology Enablers*; TR22.861 (Massive Internet of Things); TR22.862 (Critical Communications); TR 22.863 (Enhanced Mobile Broadband); TR22.864 (Network Operation).

²⁸ The hotspot capacity requirement of 10 Mbps/sq. m. is equivalent to 10 Tbps/sq. km. See also *Nokia, Ten key rules of 5G deployment, Enabling 1 Tbit/s/km² in 2030*, 2015.

²⁹ ITU Working Party 5D, *Minimal Requirements Related to Technical Performance for IMT-2020 Radio Interfaces*, Feb 22, 2017. See also 3GPP TR 38.913, *Study on Scenarios and Requirements for Next Generation Access Technologies (Release 14)*, V14.2.0, Mar. 2017.

³⁰ Per ITU, “User experienced data rate is the 5% point of the cumulative distribution function (CDF) of the user throughput.”

	IMT-Advanced	IMT-2020
Mobility	350 km/h	500 km/h
User Plane Latency	10 msec	1 msec ³¹
Connection Density	100 thousand devices/sq.km.	1 million devices sq./km.
Network Energy Efficiency	1 (normalized)	100X over IMT-Advanced
Area Traffic Capacity	0.1 Mbps/sq. m.	10 Mbps/sq. m. (hot spots)
Bandwidth	Up to 20 MHz/radio channel (up to 100 MHz aggregated)	Up to 1 GHz (single or multipole RF carriers)

In supporting different usage scenarios, not all of these objectives will necessarily be simultaneously available. For example, an IoT application may need to support a large number of devices but at lower throughput rates, while a vehicular application may need high mobility and low latency.

Other expected enhancements include:

- ❑ Deep coverage for machines buried within environments.
- ❑ Extremely low energy demands for ten years or more of battery operation.
- ❑ Low complexity options for inexpensive machine communications.
- ❑ Auto-awareness through discovery and self-optimization.

5G Concepts and Architectures

Standards bodies have not yet defined 5G requirements, but various groups are analyzing the possibilities of what might constitute 5G for network deployments in 2020 or beyond. Often stated goals of 5G include:

- ❑ Being able to support a greater number of end-systems, including IoT applications, at lower average revenue than 4G systems.
- ❑ Peak data rates of multi Gbps (see Table 4 above).
- ❑ Rather than emphasizing peak rates, a more uniform user experience across the coverage area.
- ❑ Support for many frequencies, including existing cellular bands and frequencies above 6 GHz.

³¹ Per 3GPP TR 38.913 (V14.2.0, Mar. 2017), 0.5 msec for DL and 0.5 msec for UL for URLLC and 4 msec for UL and 4 msec for DL for eMBB.

- ❑ Availability of TDD and FDD modes for all bands.
- ❑ Hierarchical/planned and ad hoc deployment models.
- ❑ Use of licensed and unlicensed bands.
- ❑ Equal support for human-type and machine-type communications. Includes highly efficient small data transmission.
- ❑ Advanced Spectrum Sharing, possibly based on spectrum sharing approaches being developed for the 3.5 GHz band.

Figure 13 shows the transformation of networks, moving from today's LTE-Advanced networks to future LTE-Advanced and eventually 5G networks.

Figure 13: Network Transformation³²

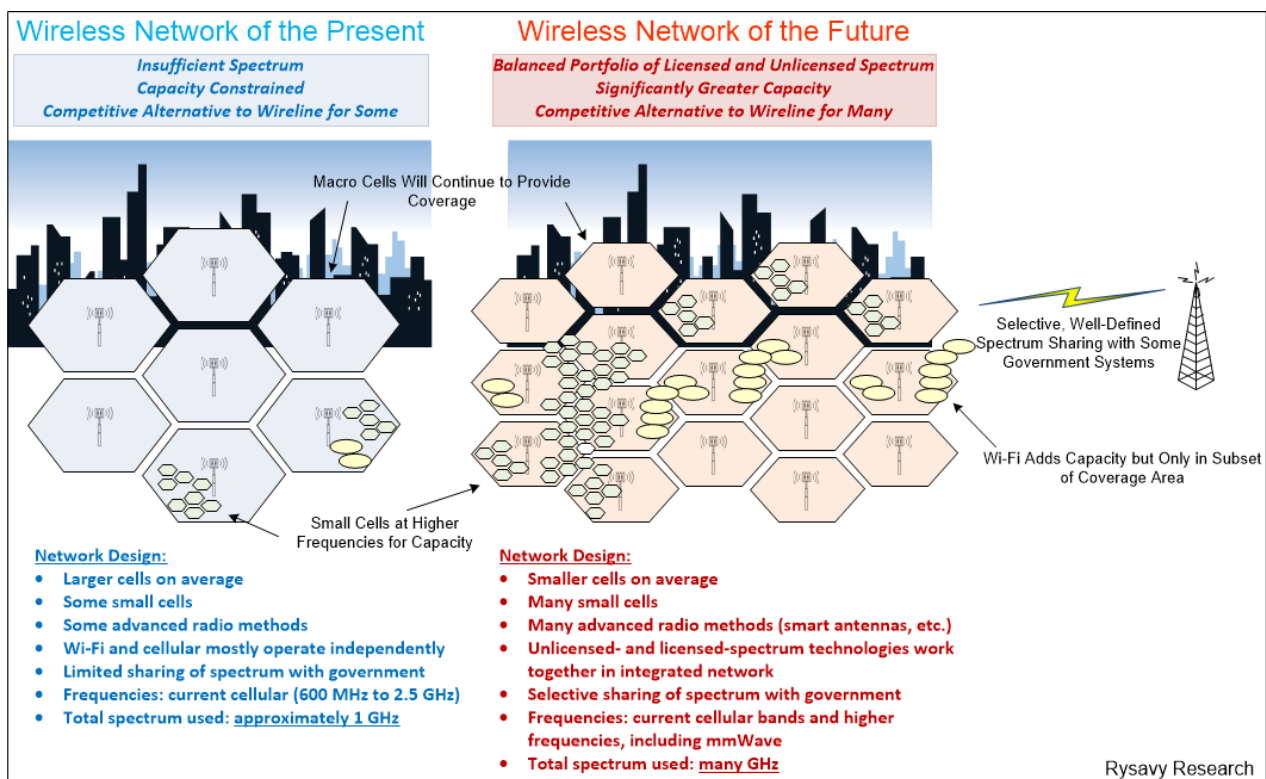

The fundamental decision for 5G is how to best leverage existing technology investments in LTE while exploiting new spectrum and new technology capabilities. 5G design emphasizes ways to combine existing 4G LTE networks with capabilities provided by 5G. One approach likely to be used by many operators is to use LTE in existing frequency bands and the 5G NR in new bands, such as mmWave, as shown in Figure 14. 5G NR, however,

³² See also Rysavy Research infographic, "Mobile Broadband Networks of the Future," April 2014. Available at <http://www.rysavv.com/Articles/2014-05-Networks-of-the-Future-Infographic.pdf>.

will operate in all frequencies, and just as 2G and 3G spectrum has been re-farmed for LTE, existing cellular bands will eventually be re-farmed for 5G.

Figure 14: 5G Combining of LTE and New Radio Technologies

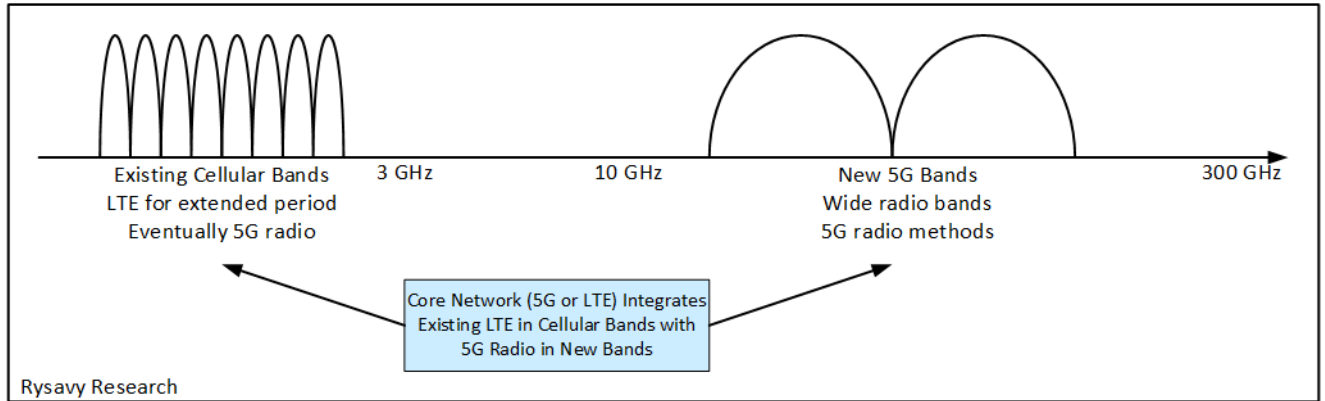

As shown in Figure 15, higher frequency bands in 5G will provide capacity with smaller cells, and lower bands will provide coverage with larger cells. This is similar to the approach taken in 4G.

Figure 15: Characteristics of Different Bands³³

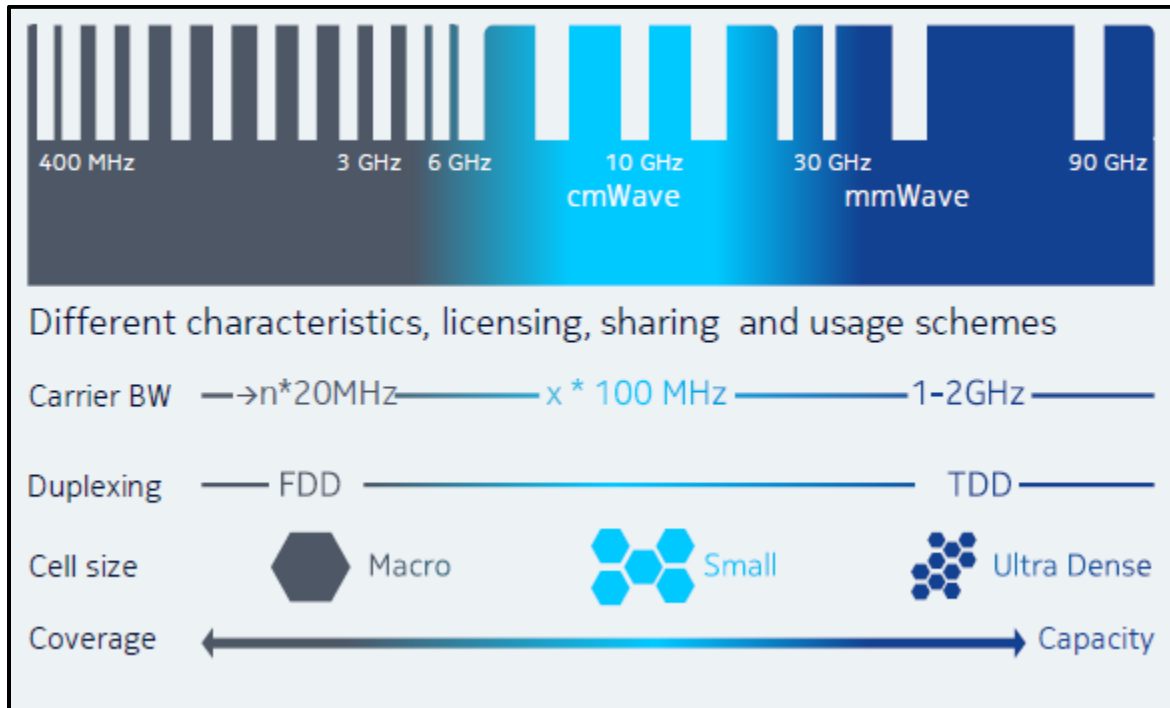

³³ Nokia, *Vision & Priorities for Next Generation Radio Technology*, 3GPP RAN workshop on 5G, Sep. 17-18, 2015.

New radio methods in NR will boost performance and will co-exist with future versions of LTE. 3GPP, in Release 14, completed a study item on 5G NR and will specify NR in Release 15.

Figure 16: Evolution to 5G Including LTE Improvements and New 5G Radio Methods

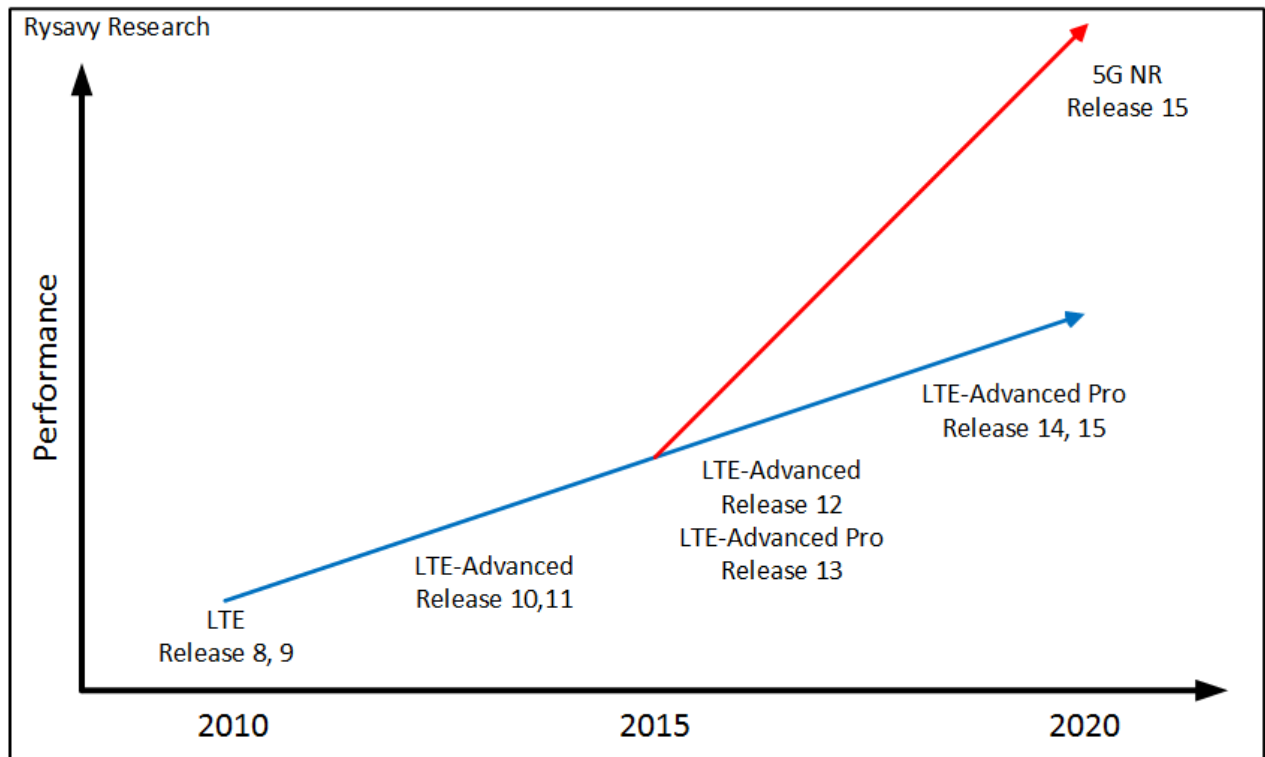

While many deployments will integrate LTE and NR, some operators could choose NR-only deployments.

5G New Radio (NR)

3GPP is defining 5G NR in Release 15, with an initial release for non-standalone operation scheduled for March 2018 and full release for standalone version scheduled for September 2018. Release 16 will add additional capabilities to the radio, such as support for URLLC. Despite specifications not being finalized, the following are planned capabilities and features of NR in Release 15:

- ❑ Ability to operate in any frequency band, including low, mid, and high bands.
- ❑ Network can support both LTE and 5G NR, including dual connectivity with which devices have simultaneous connections to LTE and NR.
- ❑ Carrier aggregation for multiple NR carriers.
- ❑ 5 Gbps peak downlink throughput in initial releases, increasing to 50 Gbps in subsequent versions.
- ❑ OFDMA in downlink and uplink, with optional Single Carrier Frequency Division Multiple Access (SC-FDMA) for uplink. Radio approach for URLLC to be defined in

Release 16, but Release 15 will provide physical layer frame structure and numerology support.

- ❑ Massive MIMO and beamforming.
- ❑ Ability to support either FDD or TDD modes for 5G radio bands.
- ❑ Numerologies of $2^N \times 15$ kHz for subcarrier spacing up to 120 kHz or 240 kHz. This approach, depicted in Figure 17, supports both narrow radio channels (for example, 1 MHz), or wide ones (for example, 400 MHz). Phase 1 likely to support a maximum of 400 MHz bandwidth with 240 kHz subcarrier spacing.
- ❑ Error correction through low-density parity codes (LDPC), which are computationally more efficient than LTE turbo codes at higher data rates.
- ❑ Standards-based cloud RAN support, compared with proprietary LTE approaches, that specifies a split between the PDCP and Radio Link Control (RLC) protocol layers.
- ❑ Self-contained integrated subframes that combine scheduling, data, and acknowledgement.
- ❑ Future-proofing by providing a flexible radio framework that has forward compatibility to support future, currently unknown services, such as URLLC to be specified in Release 16.
- ❑ Scalable transmission time intervals with short time intervals for low latency and longer time intervals for higher spectral efficiency.
- ❑ QoS support using a new model.
- ❑ Dynamic co-existence with LTE in the same radio channels. (See the Appendix section “LTE-NR Co-existence” for more details.)

According to one 5G Americas member company in 2017, operators globally have expressed interest in deploying NR in a wide variety of bands, including current cellular bands, 3.5 GHz, and mmWave bands.

Release 16 will add support for:

- ❑ URLLC.
- ❑ Shared spectrum operation.
- ❑ 5 GHz unlicensed spectrum operation based on current LTE approaches such as LAA, LWA, LWIP, and RAN Controlled LTE Wireless LAN Interworking (RCLWI).
- ❑ Possibly integrated access and backhaul based on a Release 15 study item. See the appendix section, “Integrated Access and Backhaul,” for more details.
- ❑ Other, as yet unknown, features.

The ability to simultaneously transmit and receive on the same frequency has been stated in the past as an objective of 5G, and although such capability remains of interest, it is not currently being specified.

Figure 17: Hypothetical Example of 5G Numerology

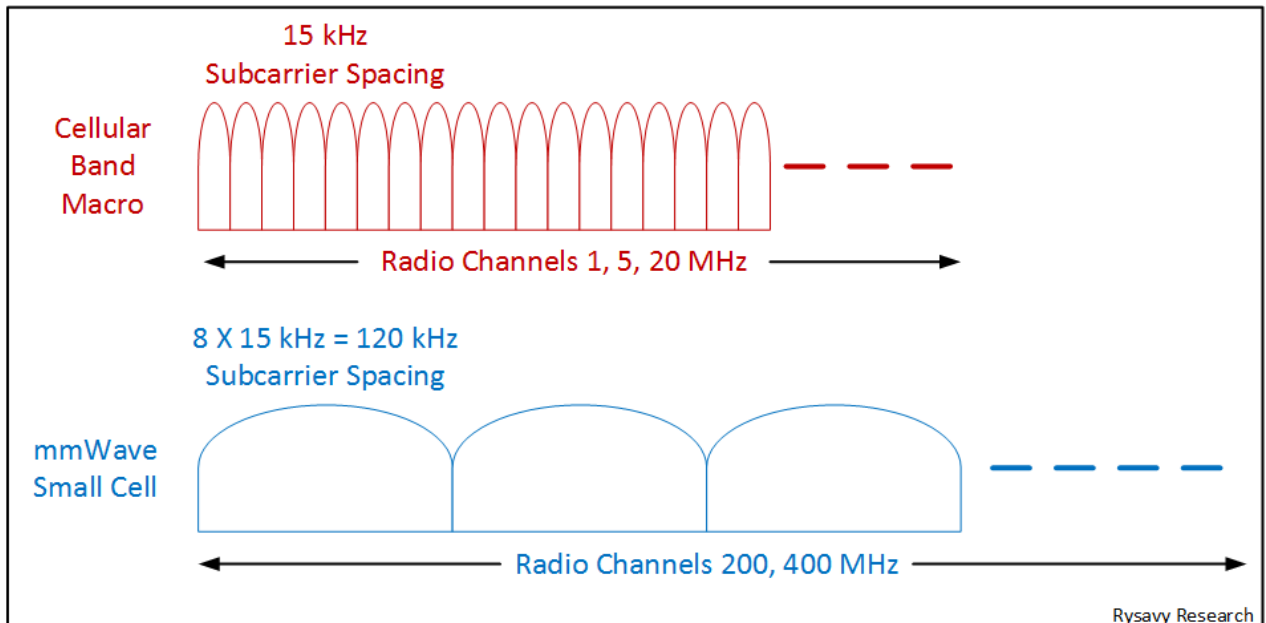

Expected 5G Performance

Predicting the 5G user experience is challenging because 5G will be deployed in many configurations, including different bands and with varying width radio channels. In addition, the throughput rates a user experiences depend on signal quality, device capability, and network loading. Some early predictions, however, are possible by examining the ITU objectives, the expected width of radio channels, and results from simulation studies.

The ITU objectives are that in a 5G network, 95% or more users should be able to experience at least 100 Mbps, which is also termed as cell-edge throughput. Examining the simulation results in the appendix section on 5G, "Performance," such results appear feasible using 200 MHz or wider radio channels. The results also suggest that average or typical rates could reach 500 Mbps using 200 MHz radio channels and 1 Gbps using 400 MHz radio channels.

Just as LTE throughputs have increased significantly over this decade, 5G performance will keep improving over the next ten years. One 5G Americas member expects that the 5G theoretical peak rate could be 5 Gbps in 2020, rising to 50 Gbps by 2024.

Release 15 Non-Standalone and Standalone Options

3GPP is specifying the first phase of 5G in Release 15. So that operators can deploy 5G sooner, 3GPP divided Release 15 into two sets of specifications. The first and earlier set of specifications define how a 5G RAN can integrate with an LTE network in what 3GPP calls a non-standalone option. In this earliest version (architecture option 3), NR will rely on an existing LTE network, both in the RAN and in the core.

The complete Release 15 specifications will also define a 5G core network. Figure 18 shows some of the architecture options. Options 3, 4 and 7 are the non-standalone options and options 1, 2, and 5 are standalone. The appendix section, "5G Architecture Options," discusses all of the deployment options in greater detail.

Figure 18: Release 15 Non-Standalone and Standalone Options

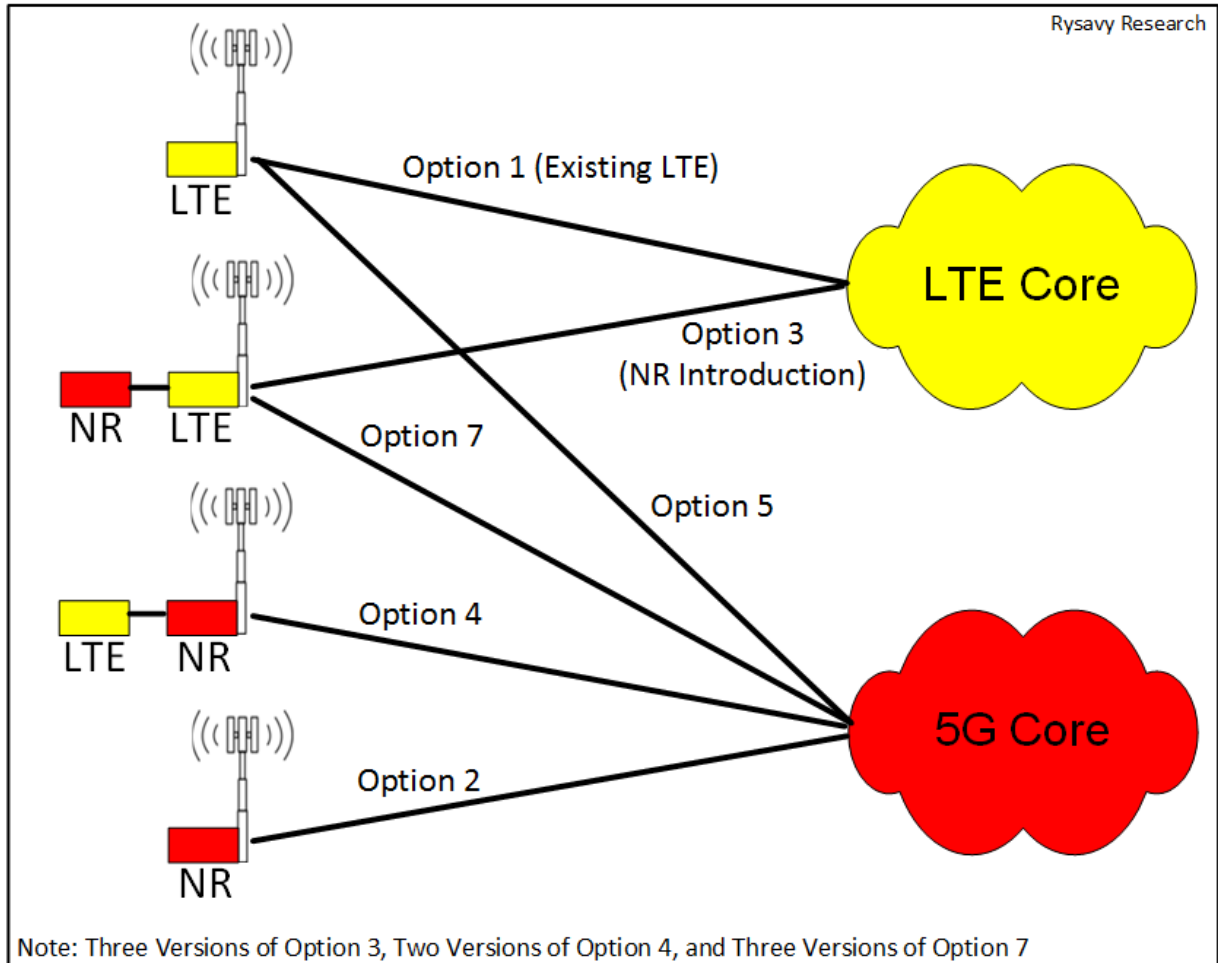
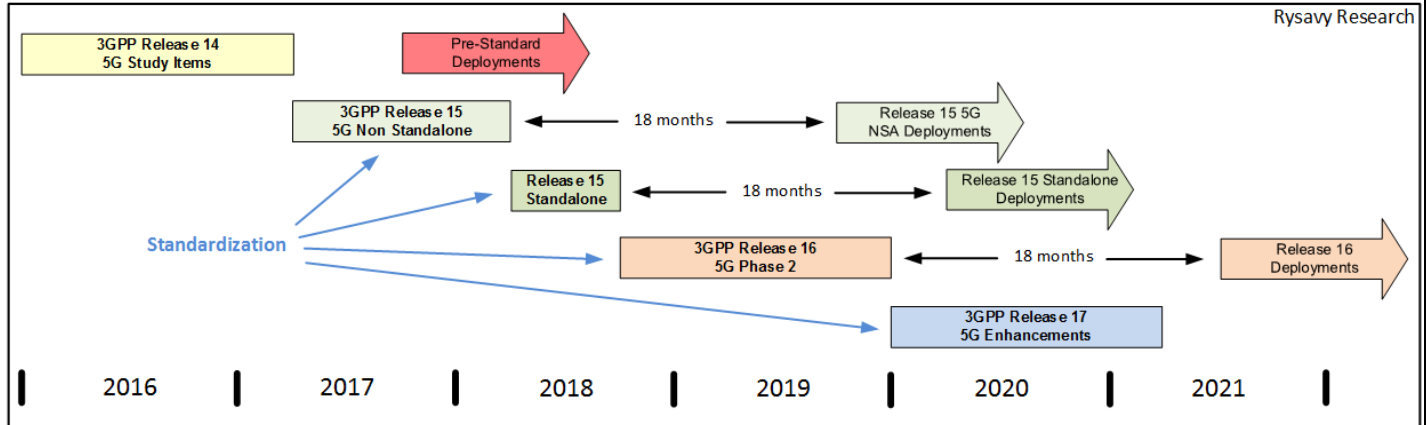

Figure 19 shows the current schedule for 5G development and deployment. 3GPP is currently standardizing 5G in Release 15, which will complete the non-standalone version of 5G in March 2018. Based on a typical minimum period of 18 months to build and deploy the technology, initial 5G NSA deployments could occur toward the end of 2019 or the beginning of 2020. 3GPP will complete the full Release 15 specifications in September 2018, enabling deployments in 2020. Release 16, which is the second phase of 5G, will be complete at the end of 2019, and Release 16 deployments could occur in 2021. In 2020, 3GPP will begin work on Release 17 which will include as yet unknown capabilities.

Figure 19: 5G Schedule³⁴



5G Core Network

Release 15 also defines initial core network capabilities that support QoS and network slicing. See the 5G appendix section, “Architecture,” for more details. A study item in Release 15 will study integrated access and backhaul, with which base stations can use the 5G radio channel for backhaul. This capability could become a work item for Release 16. See the appendix section, “Integrated Access and Backhaul,” for more details.

Many operators will virtualize their 5G core networks, just as they have for LTE, but such virtualization is outside the scope of 3GPP specifications.

5G Device Availability

User devices capable of 5G operation have not yet been announced, but availability will likely follow the trends of previous generations of networks. Initial devices, possibly in the 2019 timeframe, will likely include routers that have a 5G radio and use Wi-Fi for local Hotspot capability and USB modems. Handset vendors are in the early stages of designing mmWave support into smartphones.³⁵ These devices could come online in the 2021 timeframe, although this estimate could tighten or lengthen depending on chipset availability and handset vendor plans.

mmWave

Use of higher frequencies, such as above 6 GHz, represents one of the greatest opportunities for higher throughputs and higher capacity. This benefit derives from the potential availability of ten times the amount of spectrum as is currently available, with multiple GHz of contiguous spectrum. But these higher frequencies, especially mmWave frequencies (above 30 GHz), are suitable only over short distances, as explained below. The combination of lower and higher frequencies is therefore crucial for 5G operation. Lower bands can be devoted to coverage and control, while higher bands can provide

³⁴ 3GPP and 5G Americas member contribution. Completion based on anticipated ASN.1 freeze dates.

³⁵ For example, see “Wireless Week, Apple Wants to Test Performance at 28 GHz, 39 GHz for 5G Devices,” May 24, 2017, <https://www.wirelessweek.com/news/2017/05/apple-wants-test-performance-28-ghz-39-ghz-5g-devices>, viewed May 29, 2017.

opportunistic access for high data rates. The lower and higher spectrum bands can operate in a carrier aggregation or dual connectivity model. Initial 5G specifications include such dual-connectivity capability.

Compared with lower frequencies, mmWave frequencies suffer from worse propagation characteristics, even in line-of-sight conditions, because the comparatively smaller aperture area of the receiver's antenna requires some form of beamforming at the transmit side, and potentially even at the receive side. Fortunately, the smaller form factors of mmWave antennas allow for dense packing of antenna arrays. Experimental systems using antenna arrays have demonstrated reliable communications at 28 GHz, even in dense, urban, non-line-of-sight conditions, for distances up to 200 meters.³⁶ Arrays at the terminal side are space-constrained, but some basic beamforming at the terminal is possible. On the base station side, the arrays may include hundreds of antennas in an approach called "massive MIMO."

Figure 20 shows how an increasing number of antenna elements can extend coverage through tighter beams. A 77 X 77 antenna array (6,000 elements) can exceed a kilometer at 3.5 GHz (33 dBm transmit power) and reach over 800 meters, even at 30 GHz.

Figure 20: Range Relative to Number of Antenna Elements³⁷

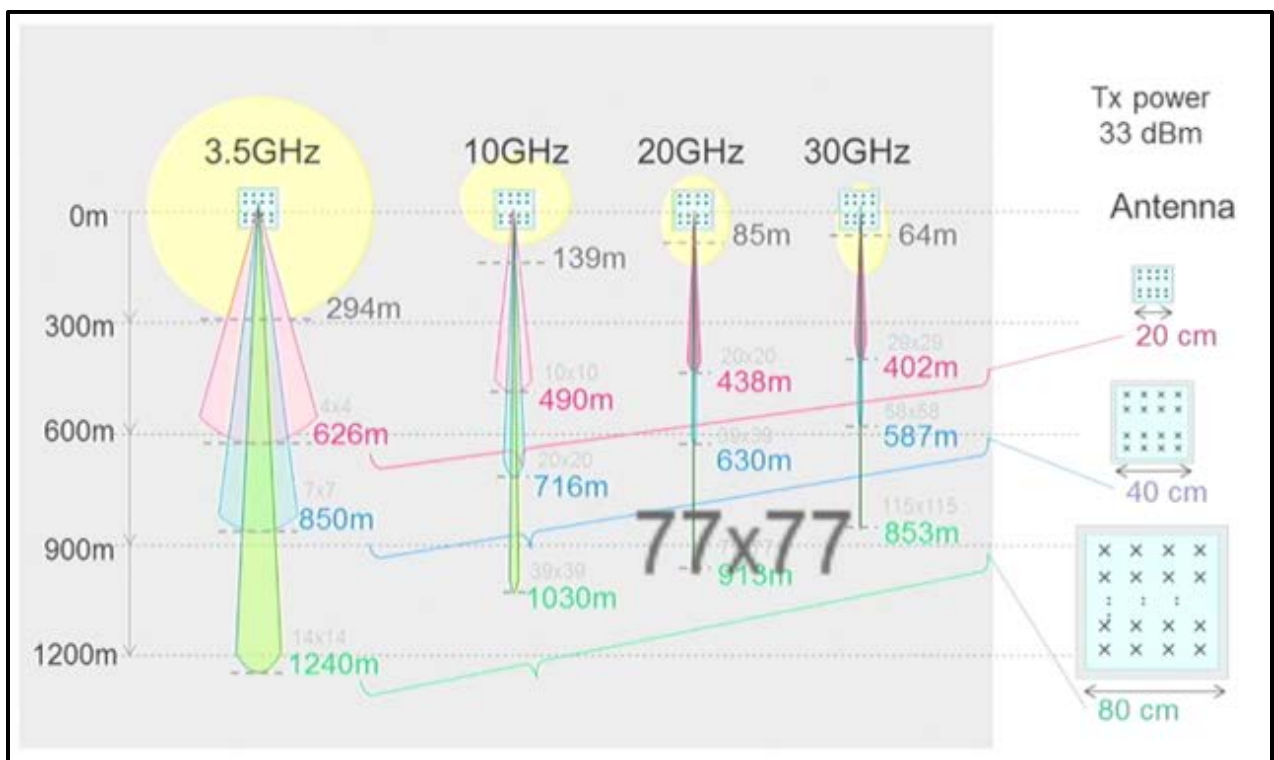

³⁶ Samsung, *5G Vision*, February 2015. Available at <http://www.samsung.com/global/business-images/insights/2015/Samsung-5G-Vision-0.pdf>.

³⁷ Dr. Seizo Onoe, NTT DOCOMO, presentation at Brooklyn 5G Summit, Apr. 21, 2016. Used by permission.

More typically, mmWave cells will employ shorter ranges of 50 to 200 meters. Extreme densification is another way that 5G networks will achieve massive increases in capacity. 3G networks reached densities of four to five base stations per sq. km, 4G networks eight to 10, but 5G networks may reach densities of 40 to 50.³⁸ A likely 5G architecture will use the macro cell for control information, coverage, and fallback, but small cells, often operating at higher frequencies, for high-bandwidth data communication. Either wireless connections or fiber will provide backhaul. Figure 21 shows how such an approach could also employ beamforming and beam tracking when using mmWave bands in the small cells.

Figure 21: 5G Architecture for Low-Band/High-Band Integration

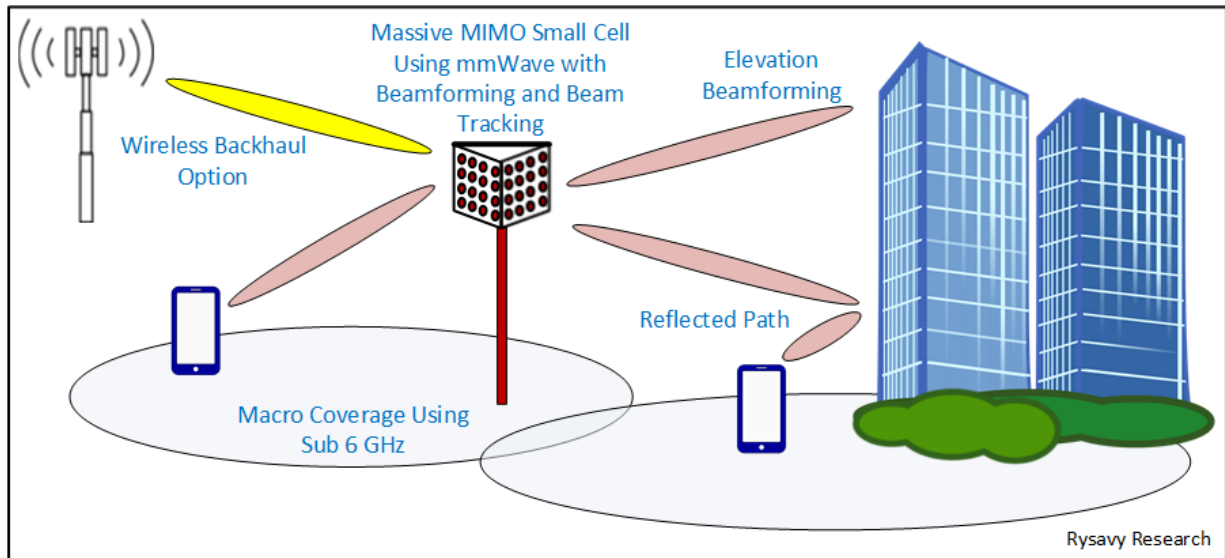

In combination, the various methods expected in 5G will provide users in mmWave band hotspot coverage at least a 100-fold increase in throughput over LTE, achieved by:

- ❑ Five- to 10-fold gains due to fewer users in each small cell. (Five to ten times as many cells.)
- ❑ 10-fold gains from access to much larger amounts of spectrum.
- ❑ Three-fold gains or more from improved spectral efficiency.

It is this huge increase in capacity, combined with Gbps performance, that will allow 5G to compete with wireline networks.³⁹

Network Slicing

Not only will 5G networks include a new radio, but thanks to virtualization, these networks will be able to present multiple faces for different use cases using a concept called network slicing. This architecture allows an operator to provide multiple services with different

³⁸ IEEE Wireless Communications, *5G Ultra-Dense Cellular Networks*, Feb. 2016.

³⁹ For a further discussion of 5G capacity and ability to compete with wireline networks, refer to Datacomm Research and Rysavy Research, *Broadband Disruption: How 5G Will Reshape the Competitive Landscape*, 2017, available at <https://datacommresearch.com/reports-broadband/>.

performance characteristics. Each network slice operates as an independent, virtualized version of the network. For an application, the network slice is the only network it sees. The other slices, to which the customer is not subscribed, are invisible and inaccessible. The advantage of this architecture is that the operator can create slices that are fine-tuned for specific use cases. One slice could target autonomous vehicles, another enhanced mobile broadband, another low-throughput IoT sensors, and so on.

Figure 22 shows the network slicing architecture, with devices having access to only the slice or slices for which they have subscriptions. Each slice has radio resources allocated, with specific QoS characteristics. Within the core network, virtualized core network functions support each slice and provide connections to external networks.⁴⁰

Figure 22: Network Slicing Architecture

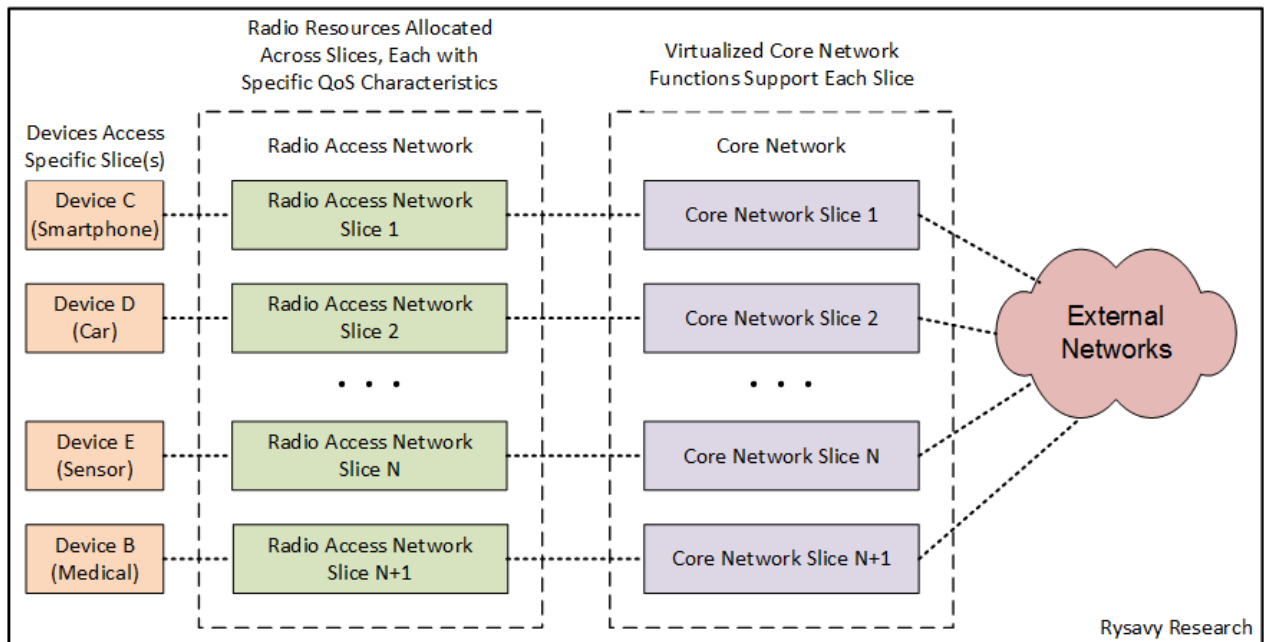

Information-Centric Networking

For many usage scenarios, wireless networks provide broadband access to the internet, a network that itself is evolving. The internet is based on a node-centric design developed forty years ago. The point-to-point method of communication the internet uses has functioned well for a vast array of applications but is not optimal for the way content is developed and distributed today. Industry and academic organizations are researching a concept called "Information-Centric Networking." ICN seeks a new approach of in-network caching that distributes content on a large scale, cost-efficiently and securely.

Most internet content uses Uniform Resource Identifiers (URIs) to locate objects and define specific location-dependent IP addresses. This approach, however, causes problems when content moves, sites change domains, or content is replicated and each copy appears as a

⁴⁰ For more details, see 5G Americas, *Network Slicing for 5G Networks & Services*, November 2016. Available at: http://www.5gamericas.org/files/3214/7975/0104/5G_Americas_Network_Slicing_11.21_Final.pdf.

different object. Developments such as peer-to-peer overlays and content distribution networks (such as Akamai) that distribute cached copies of content are a first step toward an information-centric communication model.

ICN is built from the ground up on the assumption of mobility, so it eliminates the mobility overlays on which current mobile broadband networks depend. The approach will be able to place information anywhere in the network with immediate and easy retrieval.

Key principles of ICN include:

- ❑ The architecture inherently supports user mobility.
- ❑ Network operations are name-based instead of address- or node-based.
- ❑ The network itself stores, processes, and forwards information.
- ❑ Intrinsic security guarantees the integrity of every data object.

The goal of ICN is to simplify the storage and distribution of gigantic amounts of content while reducing the amount of traffic and latency users face when accessing the content. The internet cannot just be replaced, however, so in initial stages, ICN would operate as an overlay, and over time would assume an increasing percentage of the functions within the internet. ICN would not discard IP; rather, it seeks to generalize the routing concept to enrich networking with new capabilities.

Some technology aspects of ICN include:

- ❑ Information retrieval from multiple sources without needing to know the location of the information.
- ❑ Multipath communications that improves user performance and traffic load balancing.
- ❑ Subsequent requests for the same data will be served locally without needing to fetch it from original repository.
- ❑ Elimination of the name-to-location indirection associated with Domain Name Service (DNS).

Because mobility is such a central aspect of ICN, mobile network operators are in a unique position to participate in ICN-related research and development, and to do so as part of 5G development. ICN has not progressed to a level at which 3GPP specification work could include it, so instead promoters are ensuring that 5G specification work does not preclude it. With this approach, operators in the 2020s will have the option of overlaying ICN capability on their 5G networks. ICN could even be implemented as a 5G network slice for mobile and end-systems capable of ICN.

3GPP Releases

3GPP standards development falls into three principal areas: radio interfaces, core networks, and services. Progress in the 3GPP family of technologies has occurred in multiple phases, first with GSM, then GPRS, EDGE, UMTS, HSPA, HSPA+, LTE, LTE-Advanced, and now LTE-Advanced Pro. Underlying radio approaches have evolved from Time Division Multiple Access (TDMA) to CDMA to Orthogonal Frequency Division Multiple Access (OFDMA), which is the basis of LTE. 3GPP is also involved in standardization of 5G technology.

Table 5 summarizes the key 3GPP technologies and their characteristics.

Table 5: Characteristics of 3GPP Technologies

Technology Name	Type	Characteristics	Typical Downlink Speed	Typical Uplink Speed
HSPA ⁴¹	WCDMA	Data service for UMTS networks. An enhancement to original UMTS data service.	1 Mbps to 4 Mbps	500 Kbps to 2 Mbps
HSPA+	WCDMA	Evolution of HSPA in various stages to increase throughput and capacity and to lower latency.	1.9 Mbps to 8.8 Mbps in 5+5 MHz ⁴² 3.8 Mbps to 17.6 Mbps with dual-carrier in 10+5 MHz	1 Mbps to 4 Mbps in 5+5 MHz or in 10+5 MHz
LTE	OFDMA	New radio interface that can use wide radio channels and deliver extremely high throughput rates. All communications handled in IP domain.	6.5 to 26.3 Mbps in 10+10 MHz ⁴³	6.0 to 13.0 Mbps in 10+10 MHz
LTE-Advanced	OFDMA	Advanced version of LTE designed to meet IMT-Advanced requirements.	Significant gains through carrier aggregation, 4X2 and 4X4 MIMO, and 256 QAM modulation.	

User-achievable rates and additional details on typical rates are covered in the appendix section “Data Throughput.”

3GPP develops specifications in releases, with each release addressing multiple technologies. For example, Release 8 defined dual-carrier operation for HSPA but also introduced LTE. Each release adds new features and improves performance of existing functionality in different ways. Table 6 summarizes some key features of different 3GPP releases.

⁴¹ HSPA and HSPA+ throughput rates are for a 5+5 MHz deployment.

⁴² “5+5 MHz” means 5 MHz used for the downlink and 5 MHz used for the uplink.

⁴³ 5G Americas member company analysis for downlink and uplink. Assumes single user with 50% load in other sectors. AT&T and Verizon are quoting typical user rates of 5-12 Mbps on the downlink and 2-5 Mbps on the uplink for their networks. See additional LTE throughput information in the section below, “LTE Throughput.”

Table 6: Key Features in 3GPP Releases⁴⁴

Release	Year	Key Features
99	1999	First deployable version of UMTS.
5	2002	High Speed Downlink Packet Access (HSDPA) for UMTS.
6	2005	High Speed Uplink Packet Access (HSUPA) for UMTS.
7	2008	HSPA+ with higher-order modulation and MIMO.
8	2009	Long Term Evolution. Dual-carrier HSDPA.
10	2011	LTE-Advanced, including carrier aggregation and eICIC.
11	2013	Coordinated Multi Point (CoMP).
12	2015	Public safety support. Device-to-device communications. Dual Connectivity. 256 QAM on the downlink.
13	2016	LTE-Advanced Pro features. LTE operation in unlicensed bands using LAA. Full-dimension MIMO. LTE-WLAN Aggregation. Narrowband Internet of Things.
14	2017	LTE-Advanced Pro additional features, such as eLAA (adding uplink to LAA) and cellular V2X communications. Study item for 5G "New Radio."
15	2018	Additional LTE-Advanced Pro features, such as ultra-reliable low-latency communications. Phase 1 of 5G. Will emphasize enhanced mobile broadband use case and sub-40 GHz operation. Includes Massive MIMO, beamforming, and 4G-5G interworking, including ability for LTE connectivity to a 5G CN.
16	2019	Phase 2 of 5G. Full compliance with ITU IMT-2020 requirements. Will add URLLC, spectrum sharing, unlicensed operation, and multiple other enhancements.
17	2021	Further LTE and 5G enhancements.

Refer to the Appendix section "3GPP Releases" for a more detailed listing of features in each 3GPP Release.

⁴⁴ After Release 99, release versions went to a numerical designation beginning with Release 4, instead of designation by year.

Supporting Technologies and Architectures

Network architects design networks using a deep and wide toolkit, including multiples types of cell sizes, integration with unlicensed spectrum, smart antennas, converged services, and virtualization.

Multiple Cell Types

Operators have many choices for providing coverage. Lower frequencies propagate further and thus require fewer cells for coverage. The resulting network, however, has lower capacity than one with more cells, so operators must continually evaluate cell placement with respect to both coverage and capacity.

Table 7 lists the many types of cells. Note that the distinctions, such as radius, are not absolute—perhaps one reason the term “small cell” has become popular, as it encompasses picocells, metrocells, femtocells, and sometimes Wi-Fi.

With “plug-and-play” capability derived from self-configuring and self-organizing features, small cells will increasingly be deployed in an ad hoc manner, anywhere power and backhaul are available, yet will operate in tight coordination with the rest of the network.

A proliferation of small cells inside buildings will also provide coverage from inside to outside, such as in city streets, the reverse of traditional coverage that extends from outdoor cells to inside.

Table 7: Types of Cells and Typical Characteristics (Not Formally Defined)

Type of Cell	Characteristics
Macro cell	Wide-area coverage. LTE supports cells up to 100 km in range, but typical distances are .5 to 5 km radius. Always installed outdoors.
Microcell	Covers a smaller area, such as a hotel or mall. Range to 2 km, 5-10W, and 256-512 users. Usually installed outdoors.
Picocell	Indoor or outdoor. Outdoor cells, also called “metrocells.” Typical range 15 to 200 meters outdoors and 10 to 25 meters indoors, 1-2W, 64-128 users. Deployed by operators primarily to expand capacity.
Consumer Femtocell	Indoors. Range to 10 meters, less than 50 mW, and 4 to 6 users. Capacity and coverage benefit. Usually deployed by end users using their own backhaul.
Enterprise Femtocell	Indoors. Range to 25 meters, 100-250 mW, 16-32 users. Capacity and coverage benefit. Deployed by operators.
Distributed antenna system	Expands indoor or outdoor coverage. Same hardware can support multiple operators (neutral-host) since antenna can support broad frequency range and multiple technologies. Indoor deployments are typically in larger spaces such as airports. Has also been deployed outdoors for coverage and capacity expansion.

Type of Cell	Characteristics
Remote radio head (RRH)	Uses baseband at existing macro site or centralized baseband equipment. If centralized, the system is called "cloud RAN." Requires fiber connection.
Wi-Fi	Primarily provides capacity expansion. Neutral-host capability allows multiple operators to share infrastructure.

Small Cells and Heterogeneous Networks

Historically, increasing the number of cell sites has been the primary method for increasing capacity, providing gains far greater than what can be achieved by improvements in spectral efficiency alone. The next wave of densification is by using what the industry calls "small cells."

Central to small-cell support is the heterogeneous network architecture, with multiple types of cells serving a coverage area, varying in frequencies used, radius, and even radio technology used.

HetNets offer significant increases in capacity and improvements, including:

1. Smaller cells, such as open femtocells (home-area coverage) and picocells (city-block-area coverage), inherently increase capacity because each cell serves a smaller number of users.
2. Strategic placement of picocells within the macro cell provides the means to absorb traffic in areas where there are higher concentrations of users. Locations can include businesses, airports, stadiums, convention centers, hotels, hospitals, shopping malls, high-rise residential complexes, and college campuses.
3. Smaller cells can also improve signal quality in areas where the signal from the macro cell is weak.

Essential elements for practical HetNet deployment are self-optimization and self-configuration, especially as the industry transitions from tens of thousands of cells to hundreds of thousands, and eventually to millions. The appendix covers technical aspects of HetNets in the sections, "Heterogeneous Networks and Small Cells" and "Self-Organizing Networks."

While promising in the long term, one immediate challenge in deploying a large number of small cells is backhaul, since access to fiber is not necessarily available and line-of-sight microwave links are not always feasible. Site acquisition and the need for multiple operators to deploy their own cells in a coverage area are additional challenges.⁴⁵ Figure 23 depicts the challenges.

⁴⁵ For further discussion of this topic, refer to 5G Americas and Small Cell Forum, *Small cell siting challenges*, February 2017.

Figure 23: Small-Cell Challenges

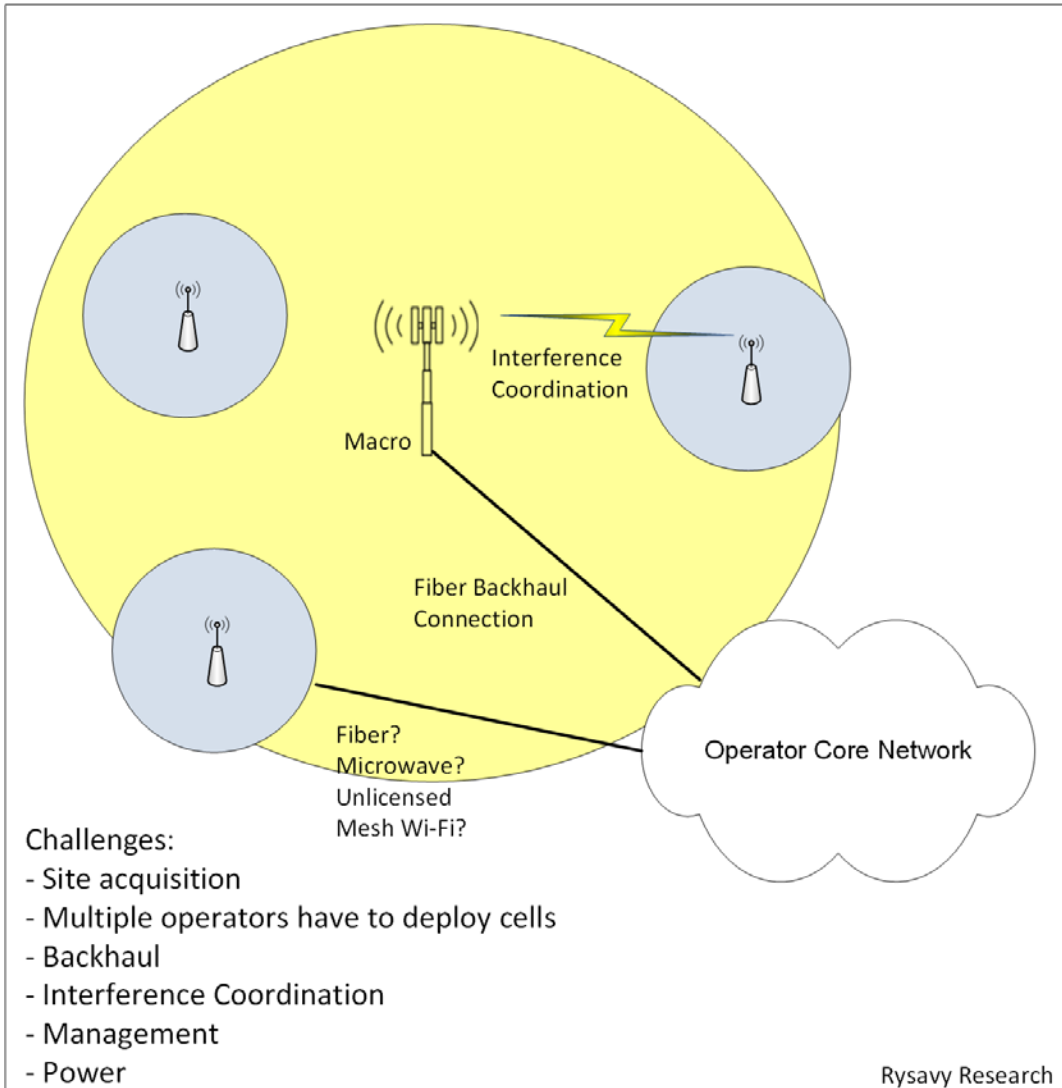

Despite these challenges and the relatively small number of small cells deployed today, many believe small-cell deployments will accelerate.⁴⁶

In the United States, the FCC in April 2017 issued a Notice of Proposed Rulemaking, titled “Accelerating Wireless Broadband Deployment by Removing Barriers to Infrastructure

⁴⁶ For example, see Fierce Wireless, “Crown Castle expects its small cell business to double in next 2 years,” April 25, 2017. Available at <http://www.fiercewireless.com/wireless/crown-castle-expects-its-small-cell-business-to-double-next-two-years>.

Investment," that seeks to streamline items such as site acquisition and consistent pricing.⁴⁷

5G small-cell considerations include:

- ❑ Due to limited propagation at mmWave frequencies, 5G small-cell deployments will be dense and involve large numbers of sites. Inter-site distances (ISDs) will range from 100 to 300 meters in many deployments, with 200 meters a typical value.⁴⁸
- ❑ The high-capacity of mmWave small cells will require multi-Gbps backhaul connections using an expected combination of fiber, mmWave radio in point-to-point connections, and 5G self-backhaul.
- ❑ The expected use of cloud RAN and centralized base station facilities will simplify equipment at the site, facilitating dense deployments.
- ❑ Dense deployments will motivate neutral-host (multi-tenant) approaches, but these are outside the scope of specification efforts.

The effective range of a mmWave small cell depends on multiple factors, including whether line-of-sight is available, extent of foliage, pole height, whether user equipment is indoors or outdoors, and the types of building materials the signal must pass through to reach indoor equipment.

Despite the challenges, small cells will ultimately contribute greatly to increased network capacity. Table 8 lists possible configurations. Note that many of these approaches can be combined, such as using picos and Wi-Fi offload.

Table 8: Small-Cell Approaches

Small-Cell Approach	Characteristics
Macro plus small cells in select areas.	Significant standards support. Femtocells or picocells can use the same radio carriers as macro (less total spectrum needed) or can use different radio carriers (greater total capacity).
Macro in licensed band plus LTE operation in unlicensed bands.	Promising approach for augmenting LTE capacity in scenarios where operator is deploying LTE small cells. ⁴⁹ See discussion below in the section on unlicensed spectrum integration.

⁴⁷ FCC, *Wireless Infrastructure NPRM and NOI*, April 21, 2017. Available at <https://www.fcc.gov/document/wireless-infrastructure-nprm-and-noi>.

⁴⁸ 5G Americas member contributions.

⁴⁹ See Rysavy Research, *Accelerating Innovation in Unlicensed Spectrum*, Fierce Wireless, November 2016. Available at <http://www.rysavy.com/Articles/2016-11-Innovation-Unlicensed-Spectrum.pdf>. See also Rysavy Research, *Will LTE in Unlicensed Spectrum Unlock a Vast Store of Mobile Broadband Capacity?* MIMO World, June 2014. Available at <http://www.mimoworld.com/?p=2377>.

Small-Cell Approach	Characteristics
Macro (or small-cell) cellular in licensed band plus Wi-Fi.	Extensively used today with increased use anticipated. Particularly attractive for expanding capacity in coverage areas where Wi-Fi infrastructure exists but small cells with LTE do not. LTE Wi-Fi Aggregation (being specified in Release 13) is another approach, as are MP-TCP and MP-QUIC.
Wi-Fi only.	Low-cost approach for high-capacity mobile broadband coverage, but impossible to provide large-area continuous coverage without cellular component.

Neutral-Host Small Cells

Multi-operator and neutral-host solutions could accelerate deployment of small cells.⁵⁰ Currently, nearly all small-cell deployments are operator-specific, but in the future, deployments supporting multiple operators could reduce the cost per operator to provide coverage.

A candidate band for neutral-host small cells is 3.5 GHz, using LTE TDD and MulteFire as potential technologies. Wi-Fi technology also addresses neutral-host configurations at the access level, but it has roaming and authentication challenges. HotSpot 2.0 (covered in the appendix) addresses roaming and authentication.

Unlicensed Spectrum Integration

Unlicensed spectrum is becoming ever more important to mobile broadband networks. Initial use was rudimentary offload onto Wi-Fi networks, but now, Wi-Fi networks are becoming more tightly integrated into cellular networks. Efforts are also underway to use LTE in unlicensed spectrum.

Unlicensed spectrum adds to capacity in two ways. First, a large amount of spectrum (approximately 500 MHz) is available across the 2.4 GHz and 5 GHz bands, with the 3.5 GHz band adding further spectrum in the future. A significant amount of unlicensed spectrum is also available in mmWave bands, with 7 GHz already in use in the United States (57 to 64 GHz) and an additional 7 GHz in 5G spectrum allocations. Second, unlicensed spectrum is mostly used in small coverage areas, resulting in high-frequency re-use and much higher throughput rates per square meter of coverage versus typical cellular deployments.

The IEEE 802.11 family of technologies has experienced rapid growth, mainly in private deployments. The latest 802.11 standard, 802.11ac, offers peak theoretical throughputs in excess of 1 Gbps and improved range through use of higher-order MIMO. 802.11ac Wave 2 products include a Multi-user MIMO capability that further increases capacity and throughput. IEEE is developing a subsequent version, 802.11ax, that emphasizes capacity

⁵⁰ 5G Americas and Small Cell Forum, *Multi-operator and neutral host small cells; Drivers, architectures, planning and regulation*, December 2016. Report available at http://www.5gamericas.org/files/4914/8193/1104/SCF191_Multi-operator_neutral_host_small_cells.pdf.

improvements as well as higher throughputs. In the mmWave frequencies, IEEE has developed 802.11ad, which operates at 60 GHz, and the standards body is currently working on a successor technology, 802.11ay.

Integration between mobile broadband and Wi-Fi networks can be either loose or tight. Loose integration means data traffic routes directly to the internet and minimizes traversal of the operator network. This is called “local breakout.” Tight integration means data traffic, or select portions thereof, may traverse the operator core network. An example is Wi-Fi calling, which uses IP Multimedia Subsystem.

Although offloading onto Wi-Fi can reduce traffic on the core network, the Wi-Fi network does not necessarily always have greater spare capacity than the cellular network. The goal of future integrated cellular/Wi-Fi networks is to intelligently load balance between the two. Simultaneous cellular/Wi-Fi connections will also become possible. For example, in Release 13, 3GPP introduces link aggregation of Wi-Fi and LTE through LWA and LWIP.

Successfully offloading data and providing users a good experience mandates measures such as automatically provisioning subscriber devices with the necessary Wi-Fi configuration options and automatically authenticating subscribers on supported public Wi-Fi networks. Many stakeholders are working toward tighter integration between Wi-Fi and cellular networks.

Another approach for using unlicensed spectrum employs LTE as the radio technology, initially in a version referred to as LTE-Unlicensed, which works with Releases 10-12 of LTE, as defined in the LTE-U Forum. In Release 13, 3GPP specified LAA, which implements listen-before-talk capability, a requirement for unlicensed operation in Europe and Japan. Initially, carrier aggregation combines a licensed carrier with an unlicensed 20 MHz carrier in the 5 GHz band as a supplemental channel, with the aggregation of multiple unlicensed channels an eventual possibility. Operating LTE in unlicensed bands could decrease the need for handoffs to Wi-Fi. Up to 32 unlicensed carriers (of 20 MHz each) can be aggregated to theoretically access 640 MHz of unlicensed spectrum. LAA may also be deployed in 3.5 GHz bands. Enhanced LAA (eLAA), specified in Release 14, adds uplink use of unlicensed spectrum. Carriers are now conducting LAA trials.⁵¹

A concern with using LTE in unlicensed bands is whether it will be a fair neighbor to Wi-Fi users. LTE-U based on Release 10-12 addresses this concern by selecting clear channels to use and measuring the channel activity of Wi-Fi users, then using an appropriate duty cycle for fair sharing. License-Assisted Access in Release 13 adds listen-before-talk (LBT) and implements other regulatory requirements that exist in some countries. 3GPP conducted a study and concluded that, “A majority of sources providing evaluation results showed at least one LBT scheme for LAA that does not impact Wi-Fi more than another Wi-Fi network.”⁵²

To address co-existence, the cellular industry worked with the Wi-Fi Alliance in 2016 to develop a test plan for LTE-U. The testing goal was to verify that, in a laboratory

⁵¹ For example, see AT&T, “AT&T Reaches Wireless Speeds of More than 750 Mbps with LTE Licensed Assisted Access (LTE-LAA) Field Trials,” available at http://about.att.com/story/lte_licensed_assisted_access_field_trials.html.

⁵² 3GPP, *Technical Specification Group Radio Access Network; Study on Licensed-Assisted Access to Unlicensed Spectrum; (Release 13)*. 36.889. See section 9, “Conclusions.”

environment, an LTE-U base station does not impact a Wi-Fi network any more than another Wi-Fi access point.⁵³

MulteFire, specified by the MulteFire Alliance, is an application of LTE in unlicensed bands that does not require an anchor in licensed spectrum, opening up the possibility of deployments by non-operator entities, including internet service providers, venue operators, and enterprises. Under a roaming arrangement with cellular operators, LTE customers could roam into MulteFire networks. Figure 24 shows the evolution of the different versions of LTE for unlicensed bands.

Figure 24: Timeline Relationship of LTE-U, LAA, eLAA, and MulteFire

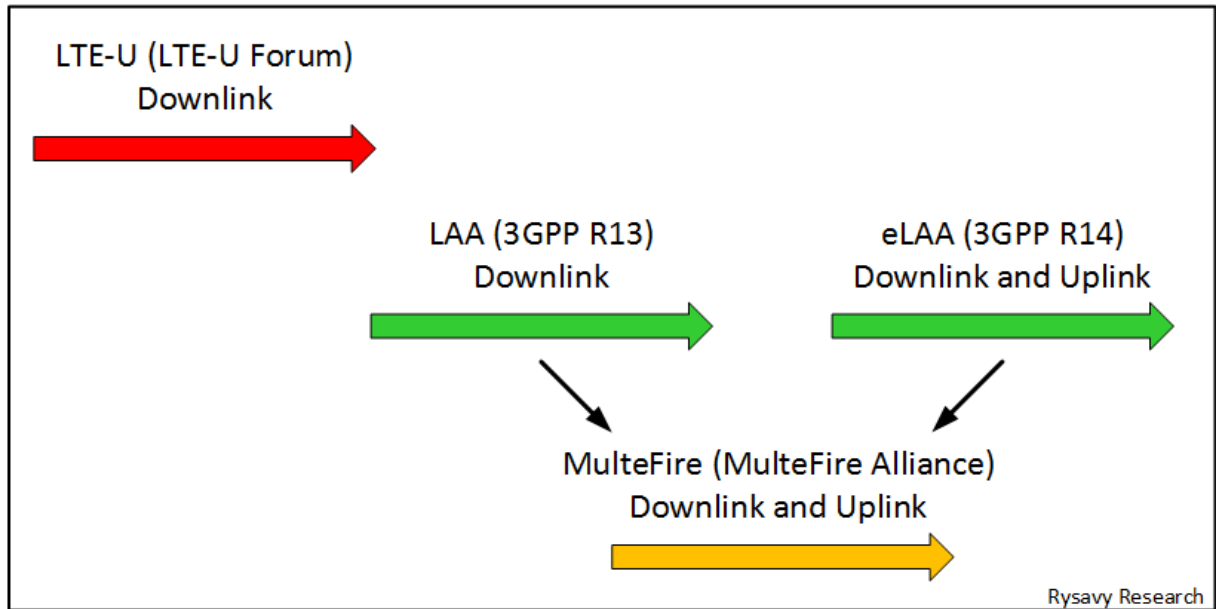

An alternative approach for integrating Wi-Fi is LWA. LTE handles the control plane, but connections occur over separate LTE base stations and Wi-Fi access points. LWA benefits operators that wish to emphasize Wi-Fi technology for harnessing capacity in unlicensed spectrum. LWIP is a variation of LWA that also integrates LTE and Wi-Fi, but by integrating at a higher level of the protocol stack (IP instead of PDCP), it facilitates use of existing Wi-Fi equipment and devices, with integration typically occurring at the eNodeB.

Figure 25 shows how the different technologies exploit licensed and unlicensed spectrum.

⁵³ See Wi-Fi Alliance, "Unlicensed Spectrum," <http://www.wi-fi.org/discover-wi-fi/unlicensed-spectrum>.

Figure 25: How Different Technologies Harness Spectrum

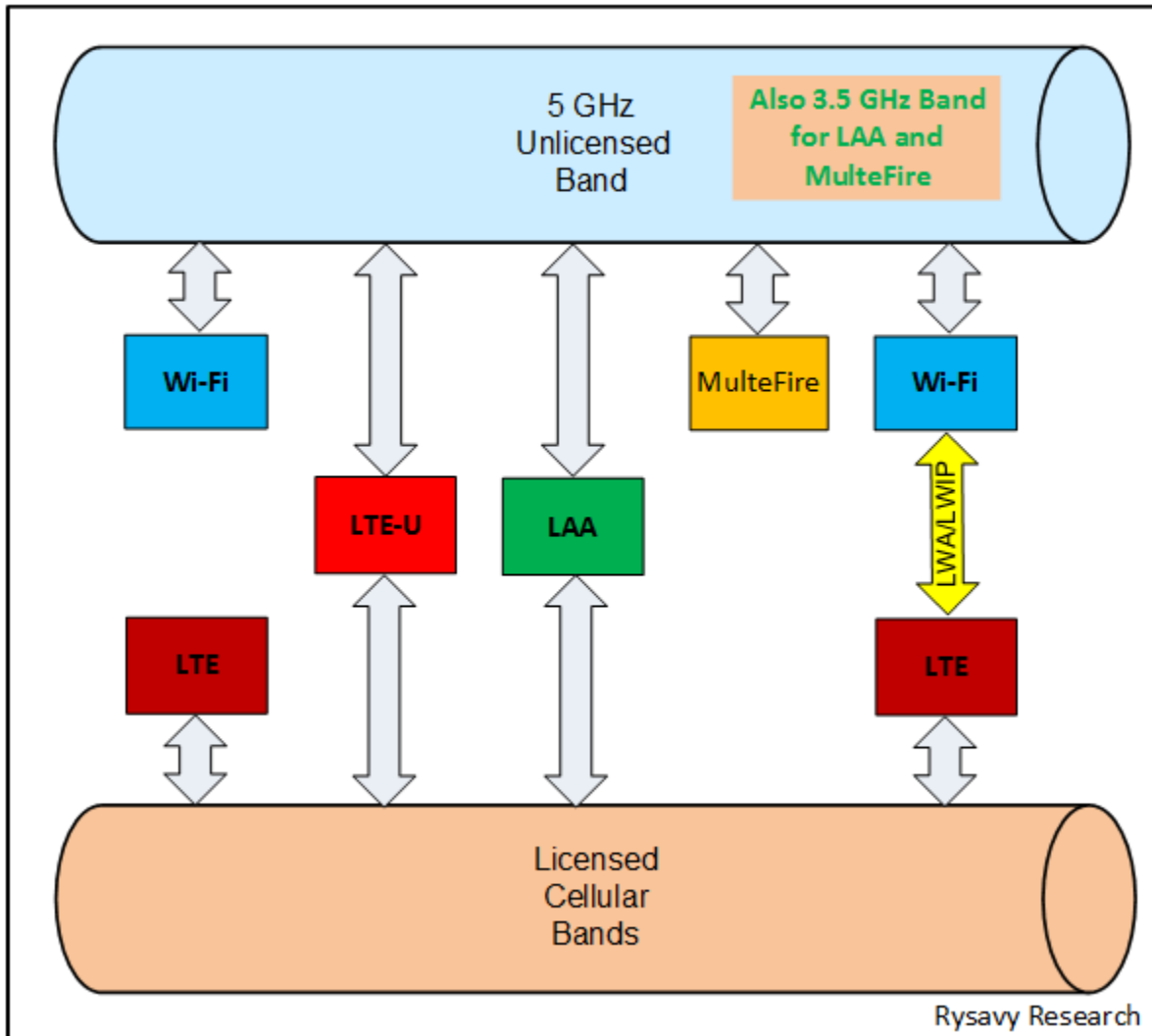

Table 9 summarizes the different uses of unlicensed spectrum for public mobile broadband networks.

Table 9: Approaches for Using Unlicensed Spectrum.

	Technology	Attributes
Wi-Fi	Ever-more-sophisticated means to integrate Wi-Fi in successive 3GPP Releases.	Combining Wi-Fi with cellular increases capacity.
Release 13 RAN Controlled LTE WLAN Interworking	Base station can instruct the UE to connect to a WLAN for offload.	Available in late 2017 or 2018 timeframe.

Release 10-12 LTE-U Based on LTE-U Forum Specifications	LTE-U Forum-specified approach for operating LTE in unlicensed spectrum.	Available in 2017. More seamless than Wi-Fi. Cannot be used in some regions (e.g., Europe, Japan).
Release 13 Licensed-Assisted Access	3GPP-specified approach for operating LTE in unlicensed spectrum. Downlink only.	Available in late 2017 or 2018 timeframe. Designed to address global regulatory requirements.
Release 14 Enhanced Licensed-Assisted Access	Addition of uplink operation.	Available in 2019 or 2020 timeframe.
5G Unlicensed Operation	Release 15 has a study item for approaches that Release 16 will standardize.	Potentially available in 2021.
MulteFire	Does not require a licensed anchor.	Potentially creates a neutral-host small cell solution.
LWA	Aggregation of LTE and Wi-Fi connections at PDCP layer.	Part of Release 13. Available in late 2017 or 2018 timeframe.
LWIP	Aggregation of LTE and Wi-Fi connections at IP layer.	Part of Release 13. Available in late 2017 or 2018 timeframe.

Cellular operators are currently emphasizing simple offload to Wi-Fi or LTE-U/LAA. Aggregation techniques, such as LWA and LWIP, do not currently have market traction.

Refer to the appendix section “Unlicensed Spectrum Integration” for further technical details.

Internet of Things and Machine-to-Machine

Machine-to-machine communications, now evolving into the Internet of Things, is a vast opportunity for wireless communications, with all 3GPP technologies potentially playing roles.

The lowest-cost cellular devices enabling M2M communications today are GPRS modems, which risk becoming obsolete as operators sunset their GSM systems. HSPA is also used for M2M communications, as is LTE, which has been optimized to efficiently communicate small bursts of information, making it particularly well suited for M2M.

Low-cost GSM (through Enhanced Coverage GSM IoT [EC-GSM-IoT]) and LTE modem options in 3GPP releases 10 through 13 reduce cost, improve communications range, and extend battery life. See the appendix section “Internet of Things and Machine-to-Machine” for details.

3GPP had a Release 13 study item on how LTE technologies can operate for vehicle communications, including vehicle-to-vehicle and vehicle-to-infrastructure, leveraging

device-to-device communications capabilities already specified for LTE in Releases 12 and 13.⁵⁴ This work is now being standardized in Release 14.

Developers will use 3GPP wireless technologies for many IoT applications. In other instances, developers will use local area technologies, such as Wi-Fi, Bluetooth Low Energy, and ZigBee. New Low-Power Wide-Area (LPWA) wireless technologies emerging specifically to support IoT include Ingenu, LoRa, and Sigfox. The low-power operation of some of these technologies, including LTE, will permit battery operation over multiple years. Table 10 summarizes the various technologies.

Table 10: Wireless Networks for IoT

Technology	Coverage	Characteristics	Standardization/ Specifications
GSM/GPRS/EC-GSM-IoT	Wide area. Huge global coverage.	Lowest-cost cellular modems, risk of network sunsets. Low-throughput.	3GPP
HSPA	Wide area. Huge global coverage.	Low-cost cellular modems. Higher power, high throughput.	3GPP
LTE, NB-IoT	Wide area. Increasing global coverage.	Wide area, expanding coverage, cost/power reductions in successive 3GPP releases. Low to high throughput options.	3GPP
Wi-Fi	Local area.	High throughput, higher power.	IEEE
ZigBee	Local area.	Low throughput, low power.	IEEE
Bluetooth Low Energy	Personal area.	Low throughput, low power.	Bluetooth Special Interest Group
LoRa	Wide area. Emerging deployments.	Low throughput, low power. Unlicensed bands (sub 1 GHz, such as 900 MHz in the U.S.)	LoRa Alliance ⁵⁵
Sigfox	Wide area. Emerging deployments.	Low throughput, low power. Unlicensed bands (sub 1 GHz such as 900 MHz in the U.S.)	Sigfox ⁵⁶

⁵⁴ 3GPP, *3GPP TR 36.885, Technical Specification Group Radio Access Network; Study on LTE-based V2X Services; (Release 14)*.

⁵⁵ For details, see LoRa Alliance, <https://www.lora-alliance.org/>.

⁵⁶ For details, see Sigfox, <https://www.sigfox.com/en>.

Technology	Coverage	Characteristics	Standardization/ Specifications
Ingenu (previously OnRamp Wireless)	Wide area. Emerging deployments.	Low throughput, low power. Using 2.4 GHz ISM band. Uses IEEE 802.15.4k.	Ingenu ⁵⁷
Weightless	Wide area. Expected deployments.	Low throughput, low power. Unlicensed bands (sub 1 GHz such as TV White-Space and 900 MHz in the U.S.)	Weightless Special Interest Group ⁵⁸

Security is of particular concern to both developers and users of IoT technology. An increasing amount of network-connected infrastructure will result in new security vulnerabilities that are being addressed by concerted effort from the industry.⁵⁹

Smart Antennas and MIMO

Smart antennas, defined with progressively greater capabilities in successive 3GPP releases, provide significant gains in throughput and capacity. By employing multiple antennas at the base station and the subscriber unit, the technology either exploits signals traveling through multiple paths in the environment or does beam steering, in which multiple antennas coordinate their transmissions to focus radio energy in a particular direction.

Initial low-band LTE deployments used 2X2 MIMO on the downlink (two base station transmit antennas, two mobiles receive antennas) and 1X2 on the uplink (one mobile transmit antenna, two base station receive antennas). In the higher bands, 2X2 downlink MIMO has been deployed, but it is more common to employ four antennas for uplink reception in a 1X4 configuration. LTE deployments are now using 4X2 MIMO and 4X4 MIMO on the downlink (four base station transmit antennas). LTE specifications encompass higher-order configurations, such as 4X4 MIMO, 8X2 MIMO, and MU-MIMO on the downlink and 1X4 on the uplink. Practical considerations, such as antenna sizes that are proportional to wavelength, dictate MIMO options for different bands.

Engineers are now experimenting with what are called massive MIMO systems, which employ a far larger number of antenna elements at the base station—64, 128, and eventually even more. Use in 5G of cmWave and mmWave bands, with their short wavelengths, will facilitate massive MIMO, but even before then, 3GPP is developing specifications for massive MIMO for 4G systems in what it calls full-dimension MIMO (FD-MIMO). Release 14 specifies configurations with up to 32 antennas at the base station.

⁵⁷ For details, see Ingenu, <https://www.ingenu.com/>.

⁵⁸ For details, see <http://www.weightless.org/>.

⁵⁹ For further insight, refer to the Ericsson white paper, *IoT Security*, February 2017, available at <https://www.ericsson.com/assets/local/publications/white-papers/wp-iot-security-february-2017.pdf>.

Massive MIMO is practical even in cellular frequencies. For example, at 2.5 GHz, an 8X8 array using half wavelength spacing would produce a form factor of 50 cm X 50 cm. Applications of such arrays include beamforming along a horizontal direction as well as beamforming in a vertical direction, such as to serve different levels of high-rise buildings.

See the appendix section “LTE Smart Antennas” and “LTE-Advanced Antenna Technologies” for further details.

Virtualization

Virtualization refers to implementing the functions of infrastructure nodes in software on commercial “off-the-shelf” computing equipment. The approach promises lower capital expenditures, lower operating costs, faster deployment of new services, energy savings, and improved network efficiency. With NFV, multiple tenants will be able to share the same infrastructure, facilitating, for example, mobile virtual network operator (MVNO) and multi-operator virtualized RAN arrangements. NFV, however, also constitutes an entirely new way of building and managing networks, so widespread adoption will occur over a long period.

Both the core network and portions of the radio-access network can be virtualized. The core network, consisting of fewer nodes, is an easier starting point. Virtualizing RAN elements, although more complex, could eventually provide the greatest network efficiency gains, particularly for small-cell deployments where it can facilitate coordination among cells and use of methods such as CoMP and interference coordination. Unlike the core, virtualizing the entire RAN is not possible because a Physical Network Function must terminate the radio interface. As operators virtualize their core networks, they put in place the systems and know-how to extend virtualization to the RAN.

The European Telecommunications Standards Institute (ETSI) is standardizing a framework, including interfaces and reference architectures for virtualization. Other standards and industry groups involved include 3GPP, the Open Networking Foundation, OpenStack, OpenDaylight, and OPNFV.

Figure 26 shows the ETSI framework, in which virtualized network functions are the nodes or applications by which operators build services.

Figure 26: ETSI NFV High-Level Framework

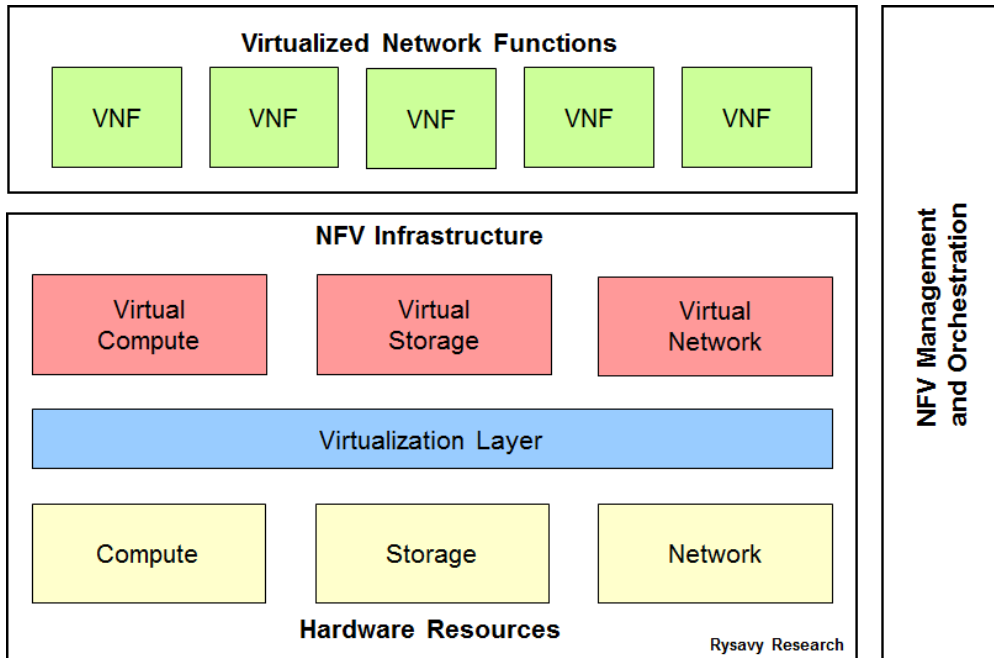

Some specific use cases for NFV include:

- ❑ **5G.** 5G networks will likely be fully virtualized.
- ❑ **IMS and VoLTE.** IMS is necessary for VoLTE, but an NFV approach could reduce the complexity associated with the multiple nodes and interfaces in the IMS architecture.
- ❑ **Virtualized EPC (VEPC).** The Evolved Packet Core, consisting of the Serving Gateway (SGW), the Packet Gateway (PGW), and Mobile Management Entity (MME), can be virtualized, but doing so will require meeting operator bandwidth, latency, and control plane service requirements.
- ❑ **New VEPC Services.** With a virtualized EPC, an operator can more easily create MVNO services, each with its own virtualized MME, SGW, and PGW. An M2M virtualized service is another example of offering a more finely tuned service for the target application. Because the PGW connects to external networks, further opportunities exist for virtualized services to augment networking functions, including video caching, video optimization, parental controls, ad insertion, and firewalls.
- ❑ **Cloud RAN.** Pooling of baseband processing in a cloud RAN can, but does not necessarily, use virtualization techniques. Separating the radio function from baseband processing typically requires transporting digitized radio signals across high-bandwidth (multi-Gbps) fiber connections, sometimes referred to as

fronthauling. Refer to the appendix section “Cloud Radio-Access Network (RAN) and Network Virtualization” for a more detailed technical discussion.⁶⁰

Because of higher investment demands, RAN virtualization will take longer to deploy than core network virtualization and likely will occur selectively for small-cell deployments.

For additional details, refer to the 5G Americas white paper, *Bringing Network Function Virtualization to LTE*.⁶¹

Multi-Access Edge Computing

ETSI is standardizing Multi-access Edge Computing, previously known as Mobile-Edge Computing, a technology that empowers a programmable application environment at the edge of the network, within the RAN.⁶² Goals include reduced latency, more efficient network operation for certain applications, and an improved user experience. Although MEC emphasizes 5G, it can also be applied to 4G LTE networks.

Applications that will benefit are ones that require server-side processing but are location specific. Examples include:

- ❑ Augmented reality.
- ❑ Intelligent video processing, such as transcoding, caching, and acceleration.
- ❑ Connected cars.
- ❑ Premise-based IoT gateways.

Multicast and Broadcast

Another important new service is video streaming via multicast or broadcast functions. 3GPP has defined multicast/broadcast capabilities for both HSPA and LTE. Mobile TV services have experienced little business success so far, but broadcasting uses the radio resource much more efficiently than having separate point-to-point streams for each user. For example, users at a sporting event might enjoy watching replays on their smartphones. The technology supports these applications; it is a matter of operators and content providers finding appealing applications. The appendix covers technical aspects in more detail.

Remote SIM Provisioning

The GSM Association (GSMA) is developing specifications that make it possible for consumers to purchase unprovisioned devices, select the operator of their choice and then download the subscriber identity module (SIM) application into the device.⁶³ This capability

⁶⁰ For further details, see “Network Functions Virtualisation,” <http://www.etsi.org/technologies-clusters/technologies/nfv>. Viewed May 17, 2017.

⁶¹ Available at http://www.4gamericas.org/files/1014/1653/1309/4G_Americas_-_NFV_to_LTE_-_November_2014_-_FINAL.pdf.

⁶² For further details, see ETSI, “Multi-access Edge Computing,” <http://www.etsi.org/technologies-clusters/technologies/multi-access-edge-computing>. Accessed May 17, 2017.

⁶³ For details, see GSMA, “A New SIM,” available at <https://www.gsma.com/rsp/>, viewed June 8, 2017.

benefits devices such as watches, health bands, health monitors, and other small connected items. Initial products may be available in 2017.

VoLTE, RCS, WebRTC, and Wi-Fi Calling

Voice has evolved from a separate circuit-switched service in 2G and 3G networks to a packet-switched service in 4G LTE networks that can integrate with other services and applications, such as messaging and video calling. Elements that make these capabilities possible include the quality-of-service mechanisms in LTE, the IMS platform discussed above, implementation of Rich Communications Suite, compliance with GSMA IR.92 guidelines, and optional support for WebRTC.

Voice Support and VoLTE

While 2G and 3G technologies were deployed from the beginning with both voice and data capabilities, LTE networks can be deployed with or without voice support. Moreover, there are two methods available: circuit-switched fallback (CSFB) to 2G/3G and VoIP. Most operators deploying LTE used CSFB initially but are now migrating to VoIP methods with VoLTE that uses IMS. Initial VoLTE deployments occurred in 2012. Because VoLTE needs new software in phones, the transition from circuit-switched voice to VoLTE on a large scale will occur over a number of years as users upgrade their devices.

For the time being, 3GPP operators with UMTS/HSPA networks will continue to use circuit-switched voice for their 3G connections.

Using VoLTE, operators can offer high-definition (HD) voice using the new Adaptive Multi-Rate Wideband (AMR-WB) voice codec. HD voice not only improves voice clarity and intelligibility, it suppresses background noise. AMR-WB extends audio bandwidth to 50-7000 Hz compared with the narrowband codec that provides audio bandwidth of 80-3700 Hz. HD voice will initially function only between callers on the same network. 3GPP has also developed a new voice codec, called "Enhanced Voice Services" (EVS), which will be the successor to AMR and AMR-WB codecs.

Other advantages of LTE's packetized voice include being able to combine it with other services, such as video calling and presence; half the call set-up time of a 3G connection; and high voice spectral efficiency. With VoLTE's HD voice quality, lower delay, and higher capacity, operators can compete against OTT VoIP providers. Due to traffic prioritization, VoLTE voice quality remains high even under heavy loads that cause OTT-voice service to deteriorate.

Applications based on WebRTC will also increasingly carry voice sessions. See the section "VoLTE and RCS" in the appendix for more details on LTE voice support.

Rich Communications Suite

An initiative called "Rich Communications Suite" (RCS), supported by many operators and vendors, builds on IMS technology to provide a consistent feature set as well as implementation guidelines, use cases, and reference implementations. RCS uses existing standards and specifications from 3GPP, Open Mobile Alliance (OMA), and GSMA and enables interoperability of supported features across operators that support the suite. RCS supports both circuit-switched and packet-switched voice and can interoperate with LTE packet voice.

Core features include:

- ❑ A user capability exchange or service discovery with which users can know the capabilities of other users.

- ❑ Enhanced (IP-based) messaging (supporting text, IM, and multimedia) with chat and messaging history.
- ❑ Enriched calls that include multimedia content (such as photo or video sharing) during voice calls. This could become the primary way operators offer video calling.

The primary drivers for RCS adoption are the ability to deploy VoLTE in a well-defined manner and to support messaging in the IP domain. RCS addresses the market trend of users moving away from traditional text-based messaging and provides a platform for operator-based services that compete with OTT messaging applications. Figure 27 shows the evolution of RCS capability, including the addition of such features as messaging across multiple devices, video calling, video sharing, and synchronized contact information across multiple devices.

Figure 27: Evolution of RCS Capability.⁶⁴

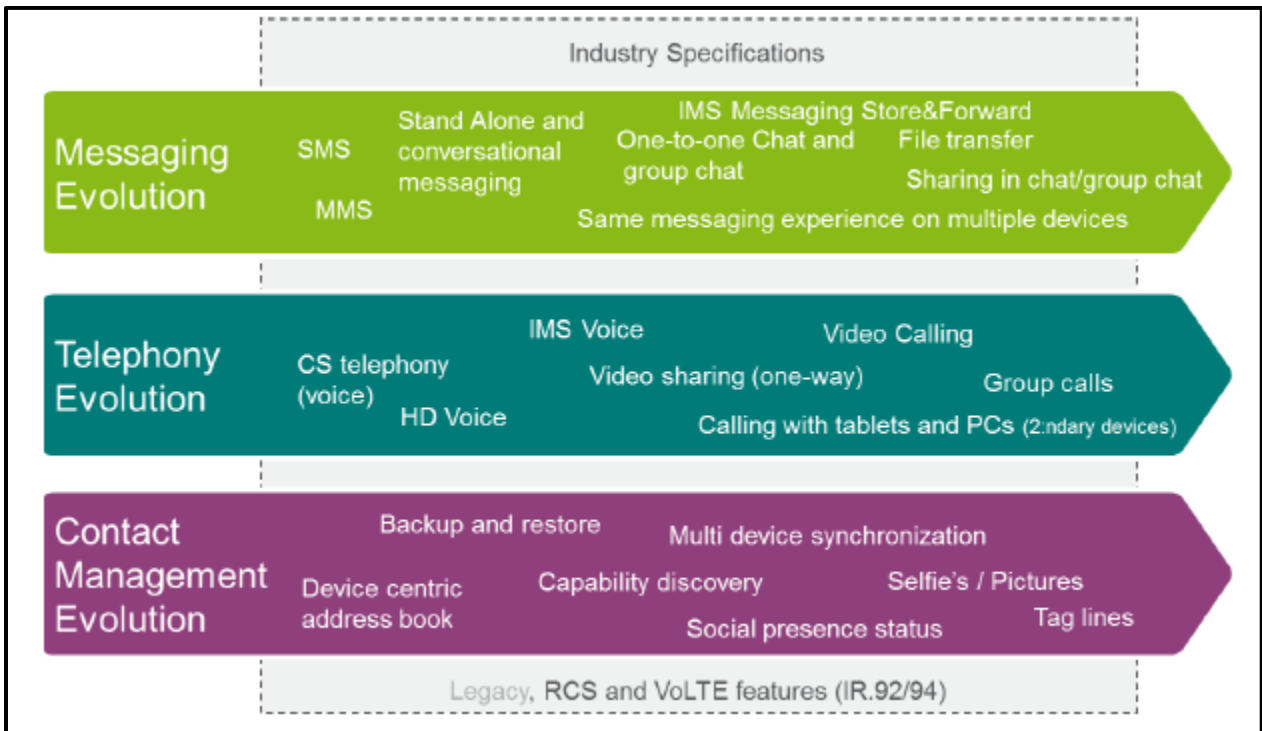

WebRTC

WebRTC is an open project supported by Google, Mozilla, and Opera within the Internet Engineering Taskforce (IETF) that enables real-time communications in Web browsers via JavaScript APIs. 3GPP Release 12 specifications define how WebRTC clients can access IMS services, including packet voice and video communication. WebRTC operating over IMS gains the additional benefit of seamless transition across transport networks, for example, LTE to Wi-Fi.

Operators can integrate WebRTC with RTC, facilitating development of vertical applications such as telemedicine and customer service. WebRTC and RCS are more complementary

⁶⁴ 4G Americas, *VoLTE and RCS Technology - Evolution and Ecosystem*, Nov. 2014.

than competitive. Both, through application interfaces, can provide access to underlying network functions.

Wi-Fi Calling

Another advantage of the VoLTE/IMS/RCS architecture is that it is agnostic to the user connection, meaning voice and video service can extend to Wi-Fi connections as easily as LTE connections. Wi-Fi calling can be advantageous in coverage areas where the Wi-Fi signal has better quality than an LTE signal. For video calling, use of Wi-Fi will also reduce data consumption over the cellular connection. By implementing a standards-based approach, as opposed to OTT-voice approaches, called parties see the same phone number regardless of network and can reach the subscriber using that phone number.

Previous technical approaches, such as Generic Access Network (GAN, initially called Unlicensed Mobile Access [UMA]), did not include as robust a handover mechanism as is provided by VoLTE/IMS.

For the best-quality voice in a Wi-Fi network, the device and Wi-Fi network should implement Wi-Fi Multimedia (WMM), which gives voice packets higher priority than other data traffic. WMM is especially necessary in congested networks. In addition, the Access Network Discovery and Selection Function (ANDSF) and cellular-WLAN enhancement features in 3GPP Release 12 have policies for enabling voice handover between LTE and Wi-Fi.

Roaming with Wi-Fi calling will need to address whether the visited network's IMS infrastructure handles the Wi-Fi call or whether the home network's IMS does.

Public Safety

An important LTE application is for public safety, initially as a broadband data service and eventually for mission-critical voice service. Current public safety networks use technologies, such as Terrestrial Trunked Radio (TETRA) in Europe and Project 25 (P25) in the United States, that provide mission-critical voice but only narrowband data.

In the United States, the government has made 20 MHz of spectrum available at 700 MHz in Band 14 and created the First Responder Network Authority (FirstNet), an independent authority within the National Telecommunications and Information Administration (NTIA) to provide a nationwide public-safety broadband network. AT&T will build and deploy the network.⁶⁵

Another country driving the use of LTE for public safety is the United Kingdom, where the UK Home Office has a program for the Emergency Service Network.

Using LTE for public safety is a complex undertaking because public-safety needs differ from those of consumers. Addressing these needs requires both different features, which 3GPP is incorporating in multiple releases of LTE specifications, and different network deployment approaches. Public safety also has different device-level needs than consumers.

LTE Features for Public Safety

Some broadband applications for public safety can use standard LTE capability. For example, sending email, accessing a database, or streaming a video may not require any special features. Other applications, however, require new capabilities from 3GPP standards, including:

Group Communication

Available in Release 12, the Group Communication Service (GCS) application server, using one-to-one (unicast) and one-to-many communications (broadcast), will be able to send voice, video, or data traffic to multiple public-safety devices. The broadcast mode will employ eMBMS to use radio resources efficiently, but if coverage is weak, a unicast approach may deliver data more reliably. The system will be able to dynamically switch between broadcast and unicast modes. Release 14 adds single-cell point-to-multipoint transmission.

Proximity-Based Services (Device-to-Device)

With proximity-based services, defined in Release 12, user devices can communicate directly, a capability that benefits both consumers and public safety. This type of communication is called sidelink communication. Consumer devices can find other devices only with assistance from the network, but for public safety, devices will be able to communicate directly with other devices independently of the network.

With Release 13, devices will be able to act as relays for out-of-coverage devices, such as inside a building.

⁶⁵ For details, see "FirstNet AT&T," <https://www.corp.att.com/public-safety/att-firstnet/>. See also RCR Wireless, *Editorial Report: Public Safety LTE*, March 2017. Available at http://content.rcrwireless.com/20170322_Public_Safety_Report.

The appendix section “Proximity Services (Device-to-Device)” discusses this feature in greater detail.

Mission-Critical Push-to-Talk

MCPTT, being defined in Release 13, provides one-to-one and one-to-many push-to-talk communications services. With this feature, available in the 2018 timeframe, public-safety organizations will be able to consider retiring legacy voice-based systems.

Mission-Critical Video over LTE and Mission-Critical Data over LTE

Release 14 adds Mission-Critical Video over LTE and Mission-Critical Data over LTE, designed to work with Mission-Critical Push-to-Talk, giving first responders more communications options.

Prioritization

To prevent interference with public-safety operations in emergency situations experiencing high load, the network can prioritize at multiple levels. First, the network can bar consumer devices from attempting to access the network, thus reducing signaling load. Second, the network can prioritize radio resources, giving public-safety users higher priority. Third, using a new capability called “Multimedia Priority Service” (MPS), the network can prioritize a connection between an emergency worker and a regular subscriber. Finally, the network can assign specific quality-of-service (QoS) parameters to specific traffic flows, including guaranteed bit rate. 3GPP has defined specific QoS quality-class identifiers for public safety.

High Power

Release 11 defines higher power devices for the public safety band that can operate at 1.25 Watts, improving coverage and reducing network deployment costs.

Isolated operation

With Release 13, a base station can continue offering service even with the loss of backhaul, a capability that will benefit public-safety personnel in disaster situations.

Relays

Figure 28 summarizes the more than eighteen features in 3GPP relays that apply to public safety.

Figure 28: Summary of 3GPP LTE Features to Support Public Safety⁶⁶

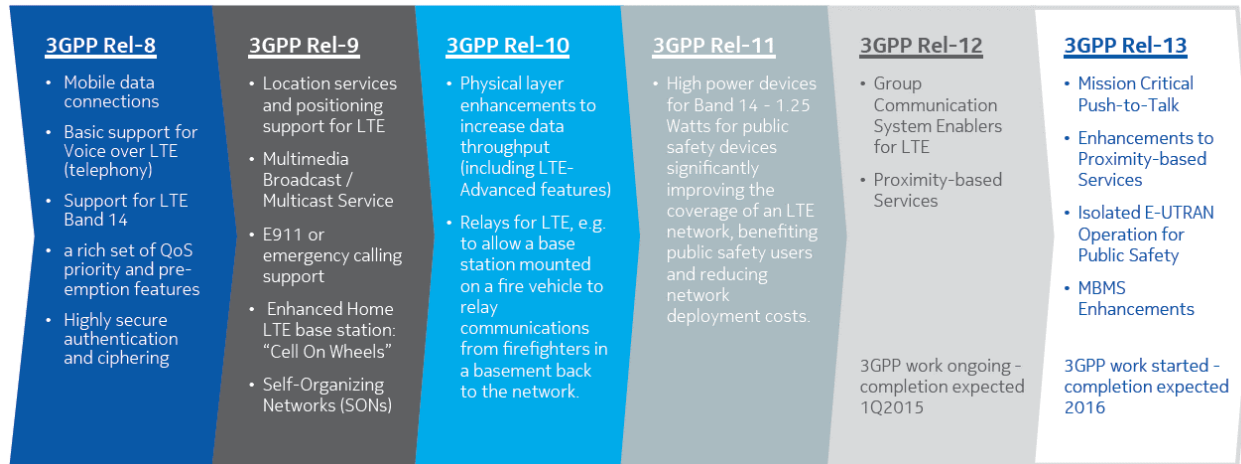

Deployment Approaches

Because huge infrastructure investments would be required for a network dedicated solely to public safety, industry and government are evaluating approaches in which public-safety users can leverage existing commercial network deployments. One caveat is that public-safety networks have more stringent resilience and security requirements than commercial networks.

Shared Network

As depicted in Figure 29, multiple sharing approaches are possible:

1. In this scenario, a public-safety entity owns and operates the entire network, an approach that gives public-safety organizations the greatest control over the network but at the highest cost.
2. A commercial operator shares its radio-access network, including cell sites and backhaul, but the public-safety entity manages core network functions including gateways, the Mobile Management Entity, the Home Subscriber Server (HSS), and public-safety application servers. Because the radio-access network is the costliest part of the network, this approach significantly reduces the amount public safety must invest in the network. Even though the RAN is shared, public safety still can use its dedicated spectrum.
3. In an MVNO approach, the operator shares its cell sites and backhaul as well as some core network functions, such as the MME and Serving Gateway. Public safety manages a small number of network functions, such as the Packet Gateway, HSS, and its application servers.

⁶⁶ Nokia, *LTE networks for public safety services*, 2014. Available at http://networks.nokia.com/sites/default/files/document/nokia_lte_for_public_safety_white_paper.pdf.

4. A final approach, not shown in the figure, is one in which the mobile operator hosts all of the elements shown in the figure and public safety manages only its application servers.

Figure 29: Sharing Approaches for Public-Safety Networks

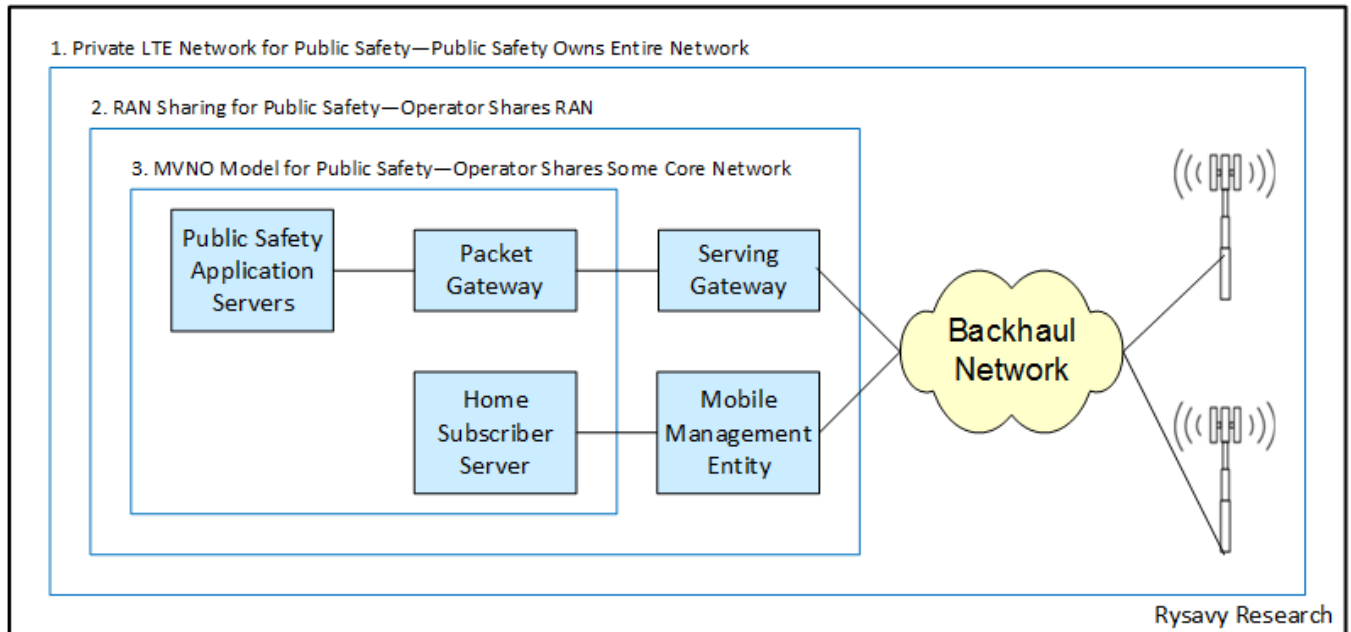

Resilience

Public safety may need greater resilience than found in commercial networks, including hardware redundancy, geographic redundancy, load balancing, fast re-routing in IP networks, interface protection, outage detection, self-healing, and automatic reconfiguration.

Security

Public-safety networks may have higher security requirements than commercial networks, including physical security of data centers, core sites, and cell sites. Whereas LTE networks do not have to encrypt traffic in backhaul and core networks, public-safety applications may choose to encrypt all IP traffic using virtual private networking approaches.

Coverage

A number of approaches can ensure the broadest possible coverage for public-safety networks. First, public-safety frequencies at 700 MHz already propagate and penetrate well. Next, public-safety devices will be able to transmit at higher power. In addition, base stations can employ four-way receiver diversity and higher-order sectorization. For disaster situations, public safety can also use rapidly deployable small cells, such as on trailers. Finally, proximity-based services operating in a relay mode, as discussed above, can extend coverage.

Device Considerations for Public Safety

Public-safety devices will have unique requirements, including guaranteed network access under all conditions and guidelines for how devices are shared among users.

Access to Commercial Networks

Public-safety devices could be designed to also communicate on commercial LTE networks, providing an alternative communications avenue when the device cannot connect to a public-safety network. Subscriptions to all major commercial networks would make this approach the most effective. Wi-Fi capability further extends this concept.

Device Sharing

Because public-safety devices may be shared among personnel, user profiles cannot be stored on USIM cards stored in the devices. Bluetooth-based remote SIMs are one approach to address this problem.

Expanding Capacity

Wireless technology is playing a profound role in networking and communications, even though wireline technologies such as fiber have inherent capacity advantages.

Over time, wireless networks will gain substantial additional capacity through the methods discussed in the next section. While they will compete with copper twisted pair and coax, they will never catch up to fiber. The infrared frequencies used in fiber-optic communications have far greater bandwidth than radio. As a result, one fiber-optic strand has greater bandwidth than the entire usable radio spectrum to 100 GHz, as illustrated in Figure 30.⁶⁷

Figure 30: RF Capacity vs. Fiber-Optic Cable Capacity

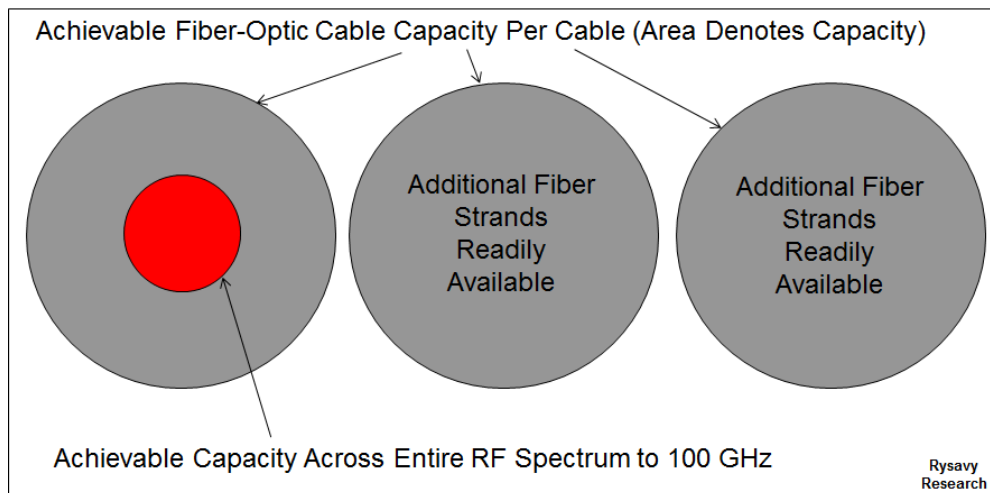

A dilemma of 4G mobile broadband is that it *can* provide a broadband experience similar to wireline, but it *cannot* do so for all subscribers in a coverage area at the same time. Hence, operators must carefully manage capacity, demand, policies, pricing plans, and user expectations. Similarly, application developers must become more conscious of the inherent constraints of wireless networks. 5G, with its far greater capacity, at least in small deployments, will increase the percentage of users that use wireless connections as their only broadband.

Three factors determine wireless network capacity, as shown in Figure 31: the amount of spectrum, the spectral efficiency of the technology, and the size of the cell. Because smaller cells serve fewer people in each cell and because there are more of them, small cells are a major contributor to increased capacity.

⁶⁷ One fiber-optic cable can transmit over 10,000 Gbps compared with all wireless spectrum to 100 GHz, which, even at an extremely high spectral efficiency 10 bps/Hz, would have only 1,000 Gbps of capacity.

Figure 31: Dimensions of Capacity

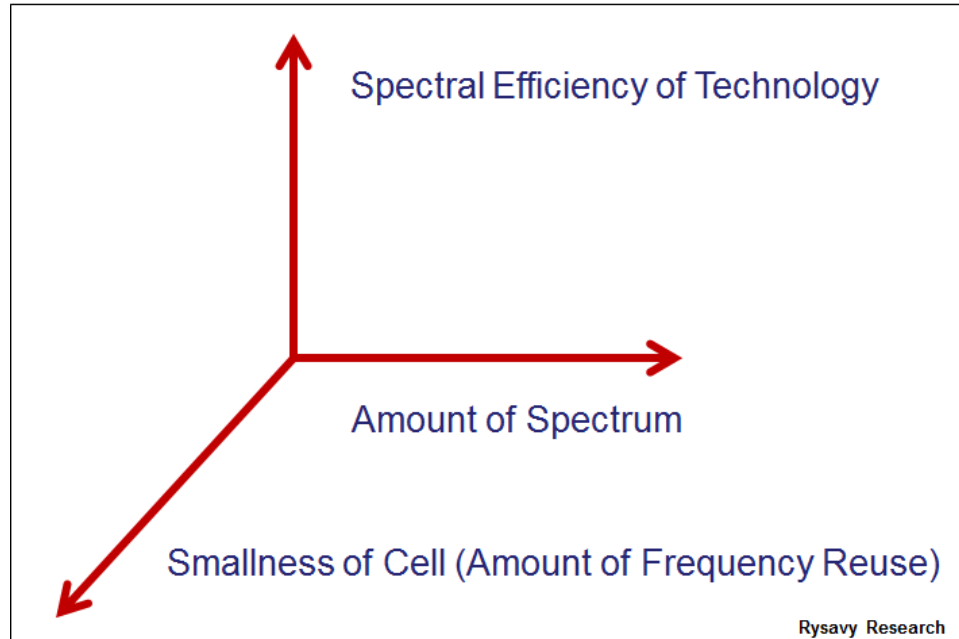

Given the relentless growth in usage, mobile operators are combining multiple approaches to increase capacity and managing congestion:

- ❑ **More spectrum.** Spectrum correlates almost directly to capacity, and more spectrum is becoming available globally for mobile broadband. In the U.S. market, the 2010 FCC National Broadband Plan is in the process of adding an additional 500 MHz of spectrum by 2020. mmWave band spectrum for 5G will provide far more spectrum, but propagation characteristics will restrict its use to small cells. Multiple papers by Rysavy Research and others⁶⁸ argue the critical need for additional spectrum.
- ❑ **Unpaired spectrum.** LTE TDD operates in unpaired spectrum. In addition, technologies such as HSPA+ and LTE permit the use of different amounts of spectrum between downlink and uplink. Additional unpaired downlink spectrum can be combined with paired spectrum to increase capacity and user throughputs.
- ❑ **Supplemental downlink.** With downlink traffic five to ten times greater than uplink traffic, operators often need to expand downlink capacity rather than uplink capacity. Using carrier aggregation, operators can augment downlink capacity by combining separate radio channels.
- ❑ **Spectrum sharing.** Policy makers are evaluating how spectrum might be shared between government and commercial entities. Although a potentially promising approach for the long term, sharing raises complex issues, as discussed further in the section "Spectrum Developments."
- ❑ **Increased spectral efficiency.** Newer technologies are spectrally more efficient, meaning greater aggregate throughput using the same amount of spectrum. Wireless technologies such as LTE, however, are reaching the theoretical limits of spectral

⁶⁸ See multiple papers on spectrum and capacity at <http://www.rysavv.com/writing>.

efficiency, and future gains will be quite modest, allowing for a possible doubling of LTE efficiency over currently deployed versions. See the section “Spectral Efficiency” for a further discussion.

- ❑ **Smart antennas.** Through higher-order MIMO and beamforming, smart antennas gain added sophistication in each 3GPP release and are the primary contributor to increased spectral efficiency (bps/Hz). Massive MIMO, beginning in Release 13, will support 16-antenna-element systems and in 5G, will expand to potentially hundreds of antenna elements.
- ❑ **Uplink gains combined with downlink carrier aggregation.** Operators can increase network capacity by applying new receive technologies at the base station (for example, large-scale antenna systems such as massive MIMO) that do not necessarily require standards support. Combined with carrier aggregation on the downlink, these receive technologies produce a high-capacity balanced network, suggesting that regulators should in some cases consider licensing just downlink spectrum.
- ❑ **Small cells and heterogeneous networks.** Selective addition of picocells to macrocells to address localized demand can significantly boost overall capacity, with a linear increase in capacity relative to the number of small cells. HetNets, which also can include femtocells, hold the promise of increasing capacity gains by a factor of four and even higher with the introduction of interference cancellation in devices. Distributed antenna systems (DAS), used principally for improved indoor coverage, can also function like small cells and increase capacity. Actual gain will depend on a number of factors, including number and placement of small cells,⁶⁹ user distribution, and any small-cell selection bias that might be applied.
- ❑ **Offload to unlicensed spectrum.** Using unlicensed spectrum with Wi-Fi or LTE operation in unlicensed spectrum offers another means of offloading heavy traffic. Unlicensed spectrum favors smaller coverage areas because interference can be better managed, so spectral re-use is high, resulting in significant capacity gains.
- ❑ **Higher level sectorization.** For some base stations, despite the more complex configuration involved, six sectors can prove advantageous versus the more traditional three sectors, deployed either in a 6X1 horizontal plane or 3X2 vertical plane.⁷⁰

Strategies to manage demand include:

- ❑ **Quality of service (QoS) management.** Through prioritization, certain traffic, such as non-time-critical downloads, could occur with lower priority, thus not affecting other active users. Current network neutrality rules, however, may constrain use of traffic prioritization.⁷¹
- ❑ **Off-peak hours.** Operators could offer user incentives or perhaps fewer restrictions on large data transfers during off-peak hours.

⁶⁹ With small-cell range expansion using a large selection bias, small cells can be distributed uniformly.

⁷⁰ An example of vertical layering would be a 3X1 layer at ground level and a separate 3X1 layer for higher levels of surrounding buildings.

⁷¹ For a discussion of this issue, see Rysavy Research, *LTE Congestion Management – Enabling Innovation and Improving the Consumer Experience*, January 2015. Available at <http://www.rysavy.com/Articles/2015-01-Rysavy-LTE-Congestion-Management.pdf>.

Given a goal of increasing capacity by a factor of 1,000, 50X could roughly be achieved through network densification; 10X through more spectrum, including higher frequencies such as mmWave; and 2X by increases in spectral efficiency.

Based on historical increases in the availability of new spectrum, technologies delivering better spectral efficiency, and increases in the number of cell sites, Rysavy Research has calculated that, over the last thirty-year period, aggregate network capacity has doubled every three years. Rysavy Research expects this trend to continue into the future.

Rysavy Research Analysis:

Aggregate Wireless Network Capacity
Doubles Every Three Years.

Spectrum Developments

Licensed spectrum scarcity continues to challenge the industry. Tactics to make the best use of this limited resource include deploying technologies that have higher spectral efficiency; adapting specifications to enable operation of UMTS-HSPA and LTE in all available bands; designing both FDD and TDD versions of technology to take advantage of both paired and unpaired bands; designing carrier aggregation techniques in HSPA+ and LTE-Advanced Pro; and deploying as many new cells, large and small, as is economically and technically feasible. Although all of these industry initiatives greatly expand capacity, they do not obviate the need for additional spectrum. 5G technology will be able to employ frequencies not previously used in cellular systems, spanning 6 GHz to 100 GHz.

An important aspect of UMTS-HSPA and LTE deployment is for infrastructure and mobile devices to accommodate the expanding number of available radio bands. The fundamental system design and networking protocols remain the same for each band; only the frequency-dependent portions of the radios must change. As other frequency bands become available for deployment, standards bodies adapt UMTS-HSPA and LTE for these bands as well.

3GPP has specified LTE for operation in many different bands, and initial use will be more fragmented than the four bands (850 MHz, 900 MHz, 1.8 GHz, 1.9 GHz) that enable global roaming on 2G and the additional two bands (1.7 GHz and 2.1 GHz) that enable 3G roaming. In the Americas, LTE roaming may occur in the 1.7/2.1 GHz (AWS) bands, and globally, LTE roaming may occur in the 1.8 and 2.6 GHz bands. Longer term, operators will re-farm spectrum used for 2G and 3G and apply it to LTE. Unfortunately, the process of identifying new spectrum and making it available for the industry is a lengthy one, as shown in Figure 32.

Figure 32: Spectrum Acquisition Time⁷²

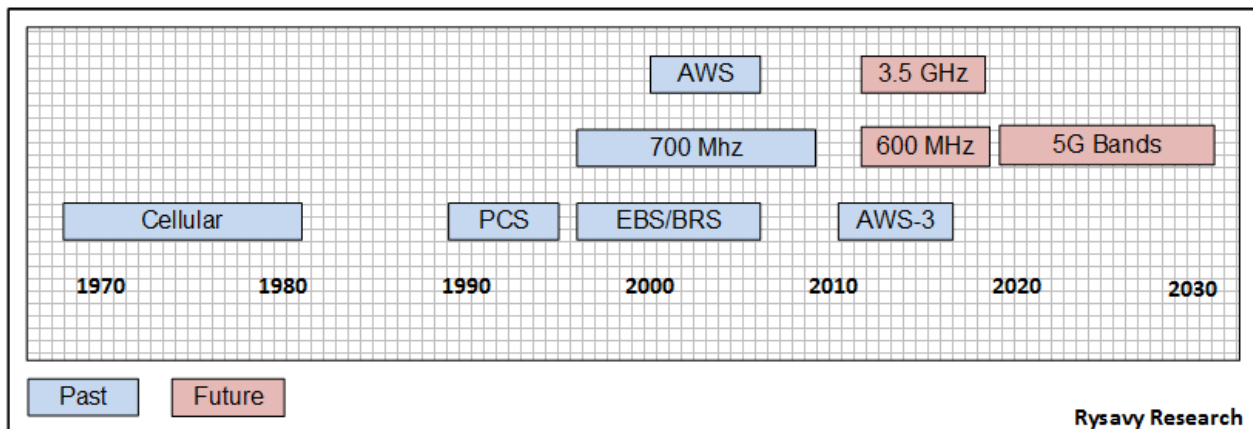

New short-term spectrum opportunities in the United States include the “small-cell” band from 3550 to 3700 MHz and 5G spectrum.

⁷² Source for historical data, FCC, *National Broadband Plan*, Chapter 5. Available at <http://www.broadband.gov/plan/5-spectrum/>, accessed May 18, 2017. Future based on Rysavy Research analysis.

Table 11 summarizes current and future spectrum allocations in the United States.⁷³

Table 11: United States Current and Future Licensed Spectrum Allocations

Frequency Band	Amount of Spectrum	Comments
600 MHz	70 MHz	Ultra-High-Frequency (UHF).
700 MHz	70 MHz	Ultra-High Frequency (UHF).
850 MHz	64 MHz	Cellular and Specialized Mobile Radio.
1.7/2.1 GHz	90 MHz	Advanced Wireless Services (AWS)-1.
1695-1710 MHz, 1755 to 1780 MHz, 2155 to 2180 MHz	65 MHz	AWS-3. Uses spectrum sharing.
1.9 GHz	140 MHz	Personal Communications Service (PCS).
2000 to 2020, 2180 to 2200 MHz	40 MHz	AWS-4 (Previously Mobile Satellite Service). ⁷⁴
2.3 GHz	20 MHz	Wireless Communications Service (WCS).
2.5 GHz	194 MHz	Broadband Radio Service. Closer to 160 MHz deployable.
	FUTURE	
3.55 to 3.70 GHz	150 MHz	Small-cell band with spectrum sharing and unlicensed use.
Above 6 GHz	Multi GHz	Anticipated for 5G systems beginning in 2017. Based on wavelengths, 3 GHz to 30 GHz is referred to as the cmWave band and 30 GHz to 300 GHz is referred to as the mmWave band.

Today's licensed spectrum networks operate most efficiently and are deployed most cost-effectively using a combination of low-band spectrum, below 1 GHz, for coverage and 1 GHz

⁷³ For international allocations, refer to Wik-Consult, Study for the European Commission, *Inventory and review of spectrum use: Assessment of the EU potential for improving spectrum efficiency*, September 2012. Available at http://ec.europa.eu/digital-agenda/sites/digital-agenda/files/cion_spectrum_inventory_executive_summary_en.pdf.

⁷⁴ Supported in 3GPP Band 70, which adds 1995-2000 MHz, pairing it with 1695-1710 MHz in AWS-3 band.

to 3 GHz for capacity. As technology improves, bands in 3 GHz to 100 GHz, and eventually higher, will supplement capacity.

The subsections below provide additional information about the recently completed AWS-3 auction, incentive auctions, the 3.5 GHz, 5G, spectrum harmonization, unlicensed spectrum, and spectrum sharing.

AWS-3

In early 2015, the FCC received close to \$45 billion for the U.S. Treasury in the AWS-3 auction, more than twice the amount of any previous auction, demonstrating the value of mid-band spectrum.⁷⁵ The auction adds 65 MHz of desirable spectrum to the mobile-broadband industry. The plan is to employ spectrum sharing among commercial networks and select government systems. Eventually, most of these government systems will migrate to another spectrum. 3GPP has specified use of both AWS-3 and AWS-4 spectrum in what it refers to as “Band 66.”

This band is asymmetrical, with a downlink of 90 MHz and an uplink of 70 MHz. An operator can use the upper-most 20 MHz of the downlink only with carrier aggregation.

Broadcast Incentive Auction (600 MHz)

The broadcast incentive auction completed in 2017 will reallocate 84 MHz of UHF channels in the 600 MHz band that are currently used by TV broadcasters, with 70 MHz of licensed spectrum and 14 MHz of unlicensed spectrum. The auction was more complicated than past spectrum auctions, when the FCC simply reassigned or designated spectrum for commercial mobile use and then conducted an auction.

In the first stage, the FCC conducted a reverse auction to determine how much spectrum broadcasters might wish to relinquish in exchange for how much compensation. In the second stage, mobile operators bid for spectrum in a forward auction, similar to past spectrum auctions.

Figure 33 shows the final band plan.

Figure 33: 600 MHz Band Plan⁷⁶

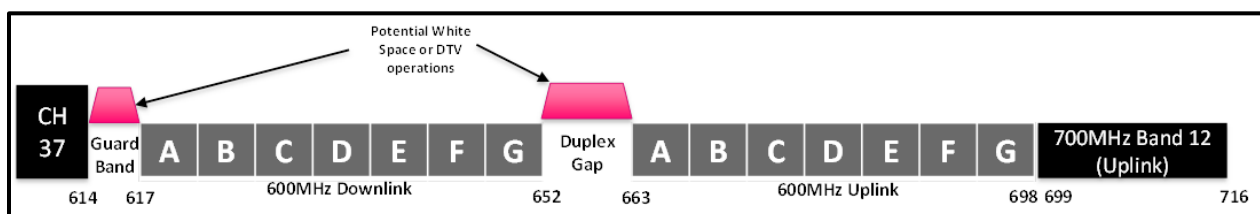

Part of the auction process reorganizes and repacks relinquished channels, as well as channels needed for broadcasters that want to keep broadcasting, to make useful blocks of spectrum for mobile broadband. The FCC’s goal is to design an auction that will result in

⁷⁵ For further details, see Rysavy Research, “Latest FCC auction shatters spectrum myths,” January 2015. Available at <https://gigaom.com/2015/01/17/latest-fcc-auction-shatters-spectrum-myths/>.

⁷⁶ 5G Americas member contribution.

a uniform nationwide band plan, but in some markets, there may be deviations from that plan.

With a 39-month schedule for winning bidders to move into their new spectrum, the 600 MHz band will be fully available by 2020. However, some operators, will begin using this spectrum in advance of this date, possibly as soon as the second half of 2017, as the spectrum becomes available for use.⁷⁷ Operators will use the band for LTE and 5G.

3550 to 3700 MHz “Small-Cell” Band

In the United States, the FCC is in the process of opening the 3550 to 3700 MHz CBRS band. The best use of this band will be small cells and backhaul. The FCC is implementing a three-tier model with incumbent access, priority access with priority access licenses (PALs), and General Authorized Access (GAA) for unlicensed users.⁷⁸ Incumbent access will include government radar systems.

Two industry organizations, the Wireless Innovation Forum⁷⁹ and the CBRS Alliance,⁸⁰ are working for the realization of 3.5 GHz systems.

The mobile broadband industry will mostly use LTE TDD in small-cell configurations, in either a licensed mode or an unlicensed mode using LAA or MulteFire.

Although this band represents a significant amount of new spectrum, potential adopters of the band have expressed concern about proposed rules for use of the band. For example:

- ❑ IEEE has stated it will not pursue a version of 802.11 for this band because exclusion zones are so large that the percentage of the U.S. population that could be served is below what is required for a successful market.⁸¹
- ❑ Licensed users will only be able to obtain three-year licenses with no automatic renewal.⁸²

Assuming LAA auctions in early 2018, initial 3.5 GHz deployments could occur in 2018. Because an Environmental Sensing Capability (ESC) has not yet been developed and

⁷⁷ For example, see FierceWireless, “T-Mobile confirms speedy 600 MHz rollout for 2017, covering 1 million+ square miles,” August 8, 2017, available at <http://www.fiercewireless.com/node/334911>.

⁷⁸ For further details, see Official FCC Blog, “Innovation in the 3.5 GHz Band: Creating a New Citizens Broadband Radio Service,” March 2015, available at <http://www.fcc.gov/blog/innovation-35-ghz-band-creating-new-citizens-broadband-radio-service>. See also FCC, *Further Notice of Proposed Rulemaking--Amendment of the Commission’s Rules with Regard to Commercial Operations in the 3550- 3650 MHz Band*, April 23, 2014.

⁷⁹ See <http://www.wirelessinnovation.org/>.

⁸⁰ See <https://www.cbrsalliance.org/>.

⁸¹ IEEE 802.11, *Comments of IEEE 802.11, In the Matter of Amendment of the Commission’s Rules with Regard to Commercial Operations in the 3550-3650 MHz Band*,” Jul, 2015. Available at <http://apps.fcc.gov/ecfs/document/view?id=60001115064>.

⁸² See Rysavy article about this band, “Scary Experimentation at 3.5 GHz,” Jun. 2016, available at <http://www.rysavy.com/Articles/2016-06-Scary-Experimentation-3-5-GHz.pdf>. See also AT&T ex-parte FCC communication, <http://apps.fcc.gov/ecfs/document/view?id=60001569272>.

approved, these initial deployments may not come to fruition in coastal areas where the ESC is needed for co-existence with military systems using those frequencies.

See the section “Spectrum Sharing” for further details of this band.

2.5 GHz Band

In the United States, the primary operator at 2.5 GHz is Sprint. In 2017, Sprint announced that they will deploy 5G in its 2.5 GHz spectrum as soon as the second half of 2019.⁸³ Having an average of 160 MHz of spectrum at 2.5 GHz in its top 100 markets, Sprint is in the process of deploying LTE-Advanced. In addition, Sprint is in an LTE deployment mode that includes the following features:

- ❑ Carrier aggregation capability between 2.5 GHz and lower bands (800MHz and 1900 MHz) and aggregating three carriers in a single band.
- ❑ TDD operation at 2.5 GHz and FDD operation in lower bands.
- ❑ 8 transmit and 8 receive radios at the base station that enables 4X2 MIMO in combination with beamforming.⁸⁴

5G Bands

As radio technology progresses, it can handle higher frequencies, and it occupies greater bandwidth. 1G systems used 30 kHz radio carriers, 2G in GSM uses 200 kHz carriers, 3G in UMTS uses 5 MHz carriers, and 4G in LTE uses carriers of up to 640 MHz through carrier aggregation.

3GPP is specifying 5G NR to be band agnostic. 5G will use low-band, mid-band, and high-band spectrum, and 3GPP is in the process of identifying candidate bands for 5G across all frequency ranges. 3GPP Technical Services Group - Radio Access Networks (TSG-RAN) agreed to a process of efficiently adding LTE/NR band combinations and carrier-aggregated NR/NR band combinations. Initial bands being considered by the 3GPP specification process include low band bands 5, 20, 28 and 71, mid-band bands 1, 3, 7, 66 and 41, and key mmWave bands. Just as it has done with LTE, over time, 3GPP will specify additional 5G bands spanning multiple frequencies.

Although 5G research and development is in its infancy, to achieve the 20 Gbps or higher throughput rates envisioned for 5G will require radio carriers such as 200 MHz or 400 MHz, bandwidths available only at frequencies above 5 GHz. Researchers globally are studying high-frequency spectrum options including both cmWave frequencies (3 GHz to 30 GHz) and mmWave (30 GHz to 300 GHz). Ten times as much spectrum, or more, could be available in these higher frequencies than in all current cellular spectrum.

⁸³ For more details, see Sprint press release, “Qualcomm, SoftBank and Sprint Announce Collaboration on 2.5 GHz 5G,” May 10, 2017, available at <http://newsroom.sprint.com/qualcomm-softbank-and-sprint-announce-collaboration-on-25-ghz-5g.htm>.

⁸⁴ For more details, see Sprint article at: <http://newsroom.sprint.com/blogs/sprint-perspectives/introducing-the-sprint-lte-plus-network--faster-stronger-more-reliable-than-ever-before.htm>

5G NR is being designed to operate in any frequency band. These bands encompass 600 MHz, current cellular bands, 3.5 GHz, and higher bands such as mmWave. Because 5G will be the first cellular technology to be able to operate in mmWave bands, industry and government are working to make such bands available for 5G.

During the World Radiocommunication Conference (WRC) 15, the ITU proposed a set of global frequencies for 5G⁸⁵, which it intends to finalize at the next conference in 2019 (WRC 19):

- ❑ 24.25–27.5GHz
- ❑ 31.8–33.4GHz
- ❑ 37–40.5GHz
- ❑ 40.5–42.5GHz
- ❑ 45.5–50.2GHz
- ❑ 50.4–52.6GHz
- ❑ 66–76GHz
- ❑ 81–86GHz
- ❑ In 2014, the FCC published a Notice of Inquiry into use of spectrum bands above 24 GHz for Mobile Radio Services,⁸⁶ followed by a Notice of Proposed Rulemaking in October 2015.⁸⁷

The FCC issued adopted rules to identify and open up 5G mmWave spectrum allocation in July 2016 that identify 3.85 GHz of licensed spectrum and 7 GHz of unlicensed spectrum: licensed use in 28 GHz, 37 GHz, and 39 GHz bands; unlicensed use in 64-71 GHz; and shared access in the 37-37.6 GHz band.

On July 24, 2016, the FCC adopted a report and order and further notice of proposed rulemaking that creates a new Part 30 for rules governing 28 GHz, 36 GHz, and 39 GHz bands, summarized in Table 12.

Table 12: United States 5G mmWave Bands⁸⁸

Bands	Details
28 GHz Band (27.5-28.35 GHz)	Currently licensed for Local Multipoint Distribution Service (LMDS). Could be licensed using either 200 or 400 MHz wide channels.

⁸⁵ 5G Americas Webcast, "LTE-Steps to 5G," Feb 12, 2016.

⁸⁶ FCC, *Notice of Inquiry, Use of Spectrum Bands above 24 GHz for Mobile Radio Services*, Oct. 17, 2014.

⁸⁷ FCC, *Notice of Proposed Rulemaking, Use of Spectrum Bands Above 24 GHz for Mobile Radio Services*, GN Docket No. 14-177, Oct 23, 2015.

⁸⁸ For more details, refer to FCC, *Report and Order and Further Notice of Proposed Rulemaking, Use of Spectrum Bands Above 24 GHz for Mobile Radio Services*, July 14, 2016. See also 5G Americas, *5G*

Bands	Details
39 GHz Band (38.6-40 GHz)	Currently licensed for fixed microwave in 50 MHz channels. Segment will be auctioned in 200 MHz blocks.
37 GHz Band (37-38.6 GHz)	Lower 37-37.6 GHz segment will be shared between federal and non-federal users. Upper 37.6-38.6 GHz segment will be auctioned in 200 MHz blocks.
64-71 GHz Band	Available for unlicensed use with same Part 15 rules as existing 57-64 GHz band.

In the 28 GHz band, satellite operations are secondary, but these operations are co-primary in the 37/39 GHz bands. Spectrum sharing may be required in some 5G bands, including 38.6 to 40 GHz, such as with fixed satellite service.

In the further notice of proposed rulemaking, the FCC is investigating additional bands, including 24 GHz, 32 GHz, 42 GHz, 47 GHz, 50 GHz, 70/80 GHz, and bands above 95 GHz.

The complex ITU harmonization process may mean that some regions, or even countries, pursue 5G bands that are not globally harmonized. For example, U.S. operators, along with operators in Korea and Japan, are planning 5G trials in the 28 GHz band, even though it is not one of the ITU bands.

Harmonization

Spectrum harmonization delivers many benefits, including higher economies of scale, better battery life, improved roaming, and reduced interference along borders.

As regulators make more spectrum available, it is important that they follow guidelines such as those espoused by 5G Americas:⁸⁹

- ❑ Configure licenses with wider bandwidths.
- ❑ Group like services together.
- ❑ Be mindful of global technology standards.
- ❑ Pursue harmonized/contiguous spectrum allocations.
- ❑ Exhaust exclusive use options before pursuing shared use.
- ❑ Because not all spectrum is fungible, align allocation with demand.

Emerging technologies such as LTE benefit from wider radio channels. These wider channels are not only spectrally more efficient, they also offer greater capacity. Figure 34 shows increasing LTE spectral efficiency obtained with wider radio channels, with 20 MHz on the

Spectrum Recommendations, April 2017, available at http://www.5gamericas.org/files/9114/9324/1786/5GA_5G_Spectrum_Recommendations_2017_FINAL.pdf. This report covers global 5G spectrum developments.

⁸⁹ 4G Americas, *Sustaining the Mobile Miracle – A 4G Americas Blueprint for Securing Mobile Broadband Spectrum in this Decade*, March 2011.

downlink and 20 MHz (20+20 MHz) on the uplink comprising the most efficient configuration.

Figure 34: LTE Spectral Efficiency as Function of Radio Channel Size⁹⁰

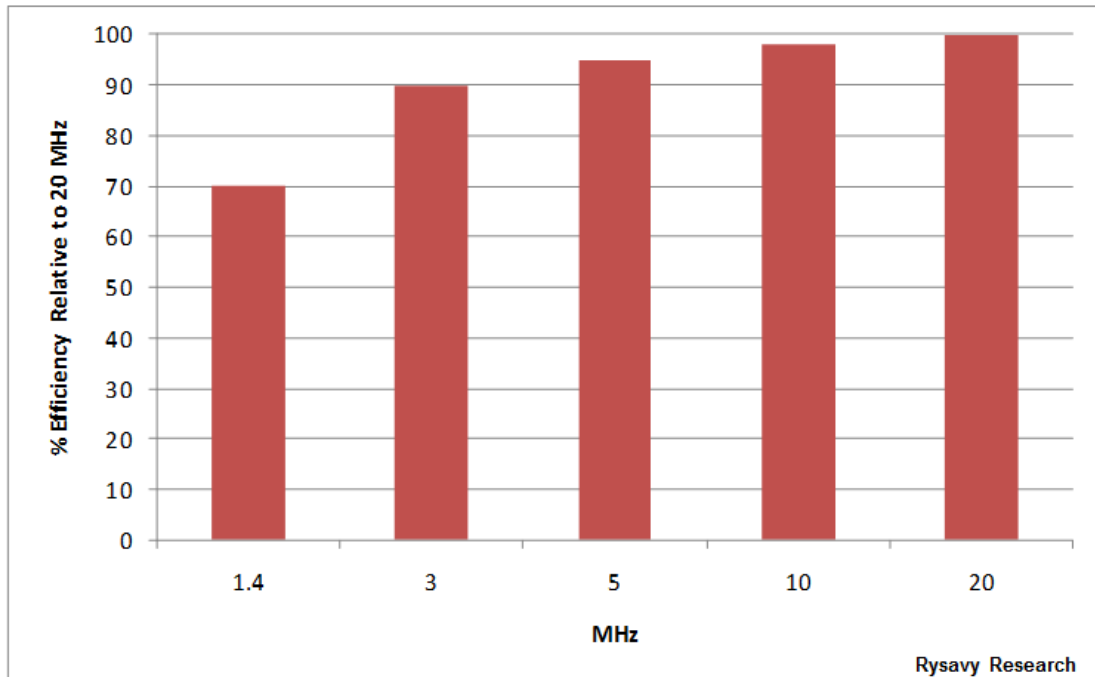

The organization tasked with global spectrum harmonization, the International Telecommunication Union, periodically holds World Radiocommunication Conferences.⁹¹

Harmonization occurs at multiple levels:

- ❑ Allocation of radio frequencies to a mobile service in the ITU frequency allocation table.
- ❑ Establishment of global or regional frequency arrangements, including channel blocks and specific duplexing modes.
- ❑ Development of detailed technical specifications and standards, including system performance, RF performance, and coexistence with other systems in neighboring bands.
- ❑ Assignment for frequency blocks with associated technical conditions and specifications to appropriate operators and service providers.⁹²

⁹⁰ 5G Americas member company analysis.

⁹¹ International Telecommunication Union, "World Radiocommunication Conferences (WRC)," <http://www.itu.int/ITU-R/index.asp?category=conferences&mlink=wrc&lang=en>, viewed May 18, 2017.

⁹² International Telecommunication Union Radiocommunication Study Groups, *Technical Perspective on Benefits Of Spectrum Harmonization for Mobile Services and IMT*, Document 5D/246-E, January 2013.

Unlicensed Spectrum

Wi-Fi uses spectrum efficiently because its small coverage areas result in high-frequency reuse and high data density (bps per square meter). Less efficient are white-space unlicensed networks, sometimes called “super Wi-Fi,” that, because of large coverage areas, have much lower throughput per square meter. While white-space networks may be a practical broadband solution in rural or undeveloped areas, they face significant challenges in urban areas that already have mobile and fixed broadband available.⁹³ See the section on “White Space Networks” in the appendix for further details.

Advocates argue that unlicensed spectrum unleashes innovation and that government should allocate greater amounts of unlicensed spectrum. Although Wi-Fi has been successful, the core elements that make unlicensed spectrum extremely successful are also the source of inherent disadvantages: local coverage and its unlicensed status. Local coverage enables high data density and high frequency reuse but makes widespread continuous coverage almost impossible. Similarly, unlicensed operation facilitates deployment by millions of entities but results in overlapping coverage and interference.

Networks built using unlicensed spectrum cannot replace networks built using licensed spectrum, and vice versa. The two are complementary and helpful to each other, as summarized in Table 13.⁹⁴

Table 13: Pros and Cons of Unlicensed and Licensed Spectrum

Unlicensed Spectrum		Licensed Spectrum	
Pros	Cons	Pros	Cons
Easy and quick to deploy	Potential of other entities using same frequencies	Huge coverage areas	Expensive infrastructure
Low-cost hardware	Difficult to impossible to provide wide-scale coverage	Able to manage quality of service	Each operator has access to only a small amount of spectrum

Some operators offer a “Wi-Fi first” capability with which devices always attempt to use a Wi-Fi connection and fall back to a cellular connection only if no Wi-Fi is available. Such cellular backup is essential because Wi-Fi, due to low-power operation in many bands, is inherently unsuited for providing continuous coverage. The sharp drop-off in signal strength due to low transmit power makes coverage gaps over large areas inevitable, especially outdoors.

⁹³ For further analysis, see Rysavy Research, “White spaces networks are not ‘super’ nor even Wi-Fi,” Gigaom, March 2013. Available at <http://gigaom.com/2013/03/17/white-spaces-networks-are-not-super-nor-even-wi-fi/>.

⁹⁴ For further analysis, see Rysavy Research, “It’s Time for a Rational Perspective on Wi-Fi,” Gigaom, April, 2014. Available at <http://gigaom.com/2014/04/27/its-time-for-a-rational-perspective-on-wi-fi/>.

Figure 35: Propagation Losses of Cellular vs. Wi-Fi⁹⁵

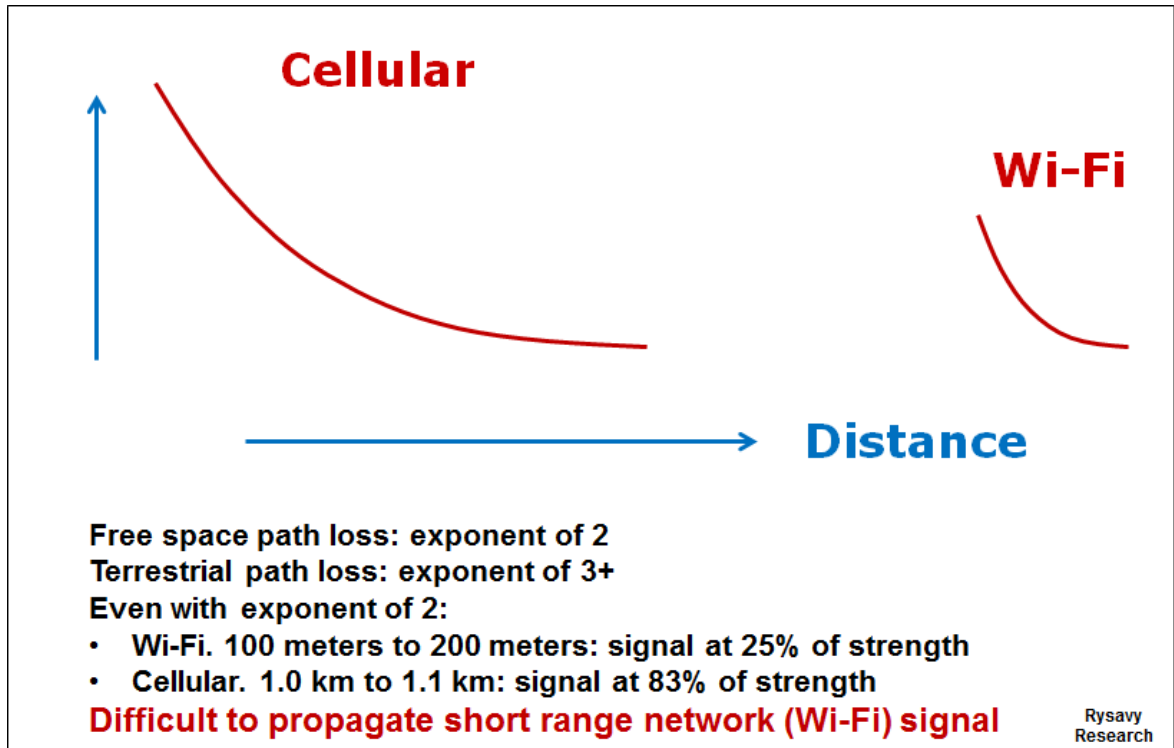

Spectrum Sharing

In 2012, the President's Council of Advisors on Science and Technology issued a report titled, "Realizing the Full Potential of Government-Held Spectrum to Spur Economic Growth." The report recommended spectrum sharing between government and commercial entities.

The U.S. government can designate spectrum for exclusive, shared, or unlicensed use, as shown in Figure 36. Shared use can be opportunistic, as with TV white spaces; two-tier with incumbents and licensed users; or three-tier, which adds opportunistic access. The bands initially targeted for spectrum sharing include AWS-3 (two tiers on a temporary basis) and the 3.5 GHz band (three tiers).

The three-tier plan envisioned by the U.S. government for the 3.5 GHz band gives more entities access to the spectrum but at the cost of increased complexity.

⁹⁵ Assumes 1.0 km radius for cellular and 100-meter radius for Wi-Fi.

Figure 36: Spectrum Use and Sharing Approaches

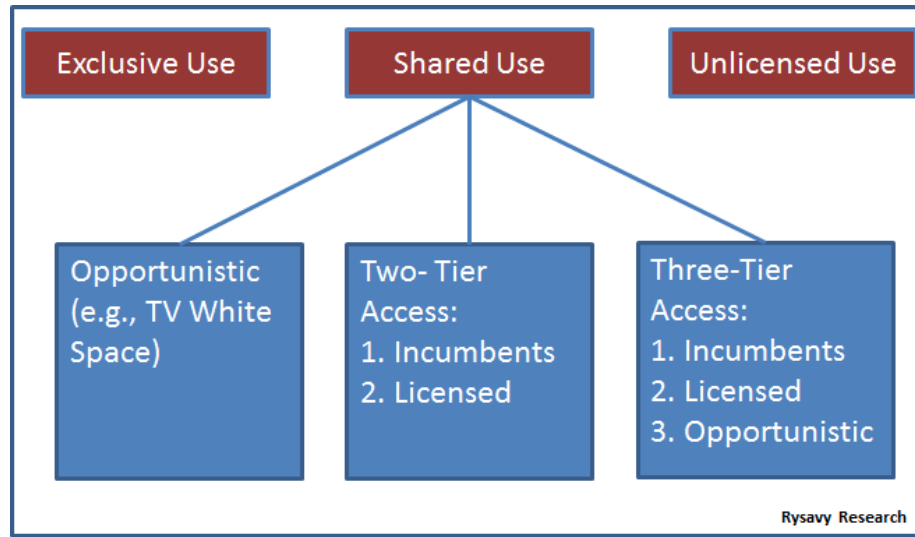

The European Telecommunications Standards Institute (ETSI) is the leading organization standardizing cognitive radios. The most relevant effort is called “Licensed Shared Access” (LSA), a two-tier spectrum sharing system that includes incumbents and licensed secondary users that access shared spectrum via a database, as depicted in Figure 37.

Figure 37: Licensed Shared Access (LSA)

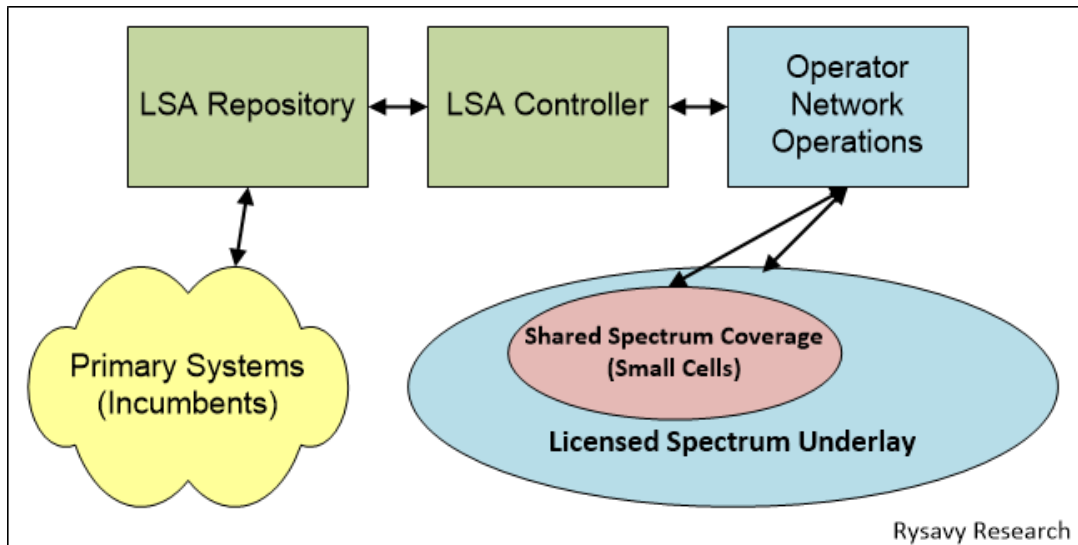

The three-tier system expected for the 3.5 GHz band in the United States will be complex, necessitating a real-time Spectrum Access System, the SAS, the design and development of which will encompass:

- ❑ Algorithms and methods;
- ❑ Methods of nesting hierarchical SAS entities (federal secure SAS versus commercial SASs);

- ❑ Coordination among multiple, competing commercial SAS managing entities;
- ❑ Interface definitions;
- ❑ Communication protocol definitions;
- ❑ Database and protocol security;
- ❑ Policy enforcement;
- ❑ Speed of channel allocation/reallocation;
- ❑ Time intervals for spectrum allocation;
- ❑ Effectively managing large numbers of Tier 3 users; and
- ❑ Data ownership, fees, rules, fairness, and conflict resolutions, all of which have policy, regulatory, and business implications.

TVWS databases available today address only a tiny subset of these requirements.⁹⁶

Figure 38 shows the proposed architecture of the 3.5 GHz system. The system consists of incumbents (government systems), Priority Access Licenses, and General Authorized Access. Government systems include military ship-borne radar, military ground-based radar, fixed satellite service earth stations (receive only), and government broadband services (3650 to 3700 MHz). PAL licenses will be used by entities such as cellular operators and will be available for three-year periods. GAA users are licensed by rule and must protect both incumbents and PALs. Incumbents are protected by an Environmental Sensing Capability that detects incumbents and informs the SAS. Some examples of GAA use cases are small-business hotspots, campus hotspots, and backhaul.

Citizens Broadband Radio Service Devices (CBSDs) are the base stations operating under this service; they can operate only under the authority and management of the SAS, either by direct communications or a proxy node.

⁹⁶ For further analysis, see Rysavy Research and Mobile Future, *Complexities of Spectrum Sharing: How to Move Forward*, April 2014. Available at <http://www.rysavy.com/Articles/2014-04-Spectrum-Sharing-Complexities.pdf>.

Figure 38: United States 3.5 GHz System Currently Being Developed

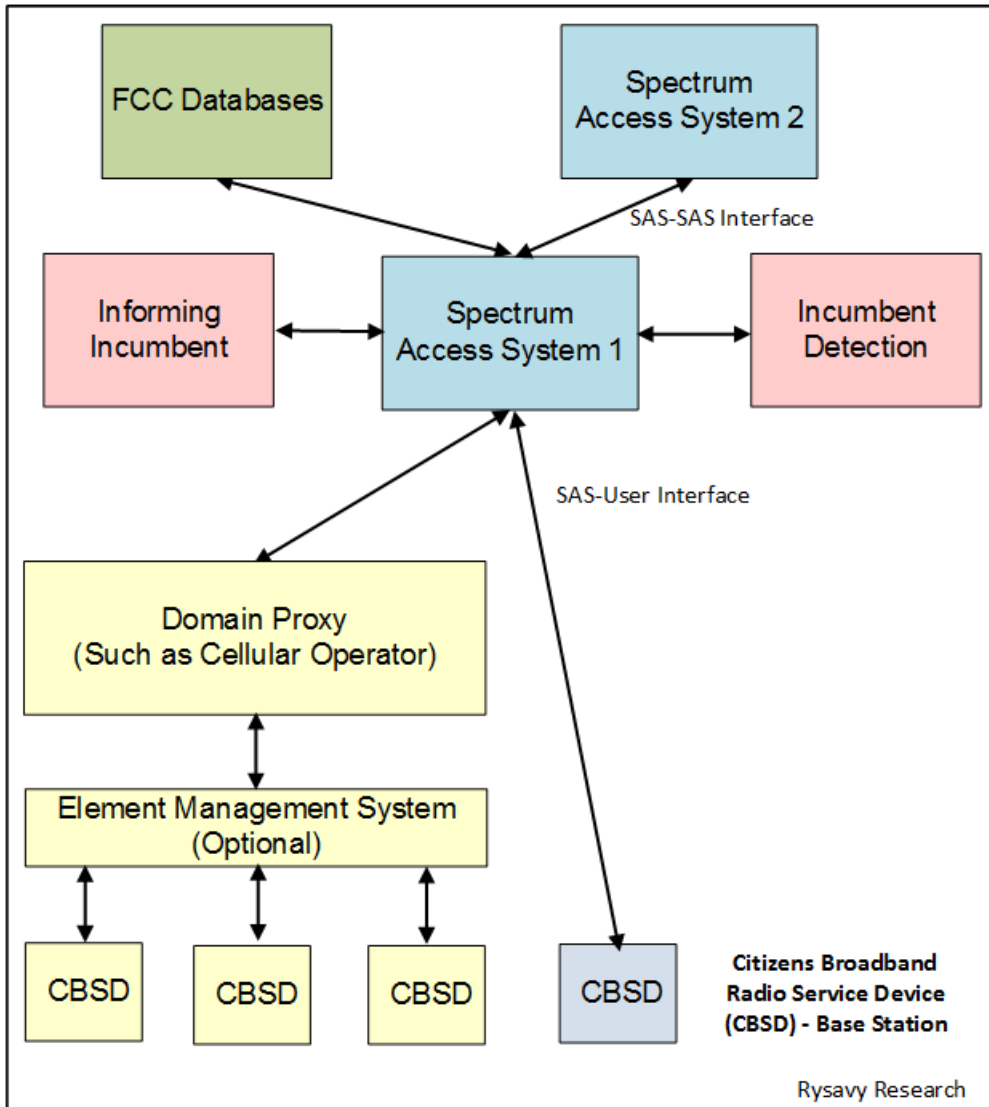

Conclusion

Mobile broadband remains at the forefront of innovation and development in computing, networking, and application development. As users, and now machines, consume ever more wireless data, the industry is responding with more efficient, faster, and higher capacity networks. Even as excitement builds about 5G, LTE, through ongoing advances, has become the global standard.

LTE-Advanced and LTE-Advanced Pro innovations include VoLTE, 1 Gbps peak rate capability, higher-order MIMO, carrier aggregation, LAA/LWA/LWIP, IoT capabilities in Narrowband-IoT and Category M-1, V2X communications, small-cell support, URLLC, SON, dual connectivity, and CoMP—all capabilities that will improve performance, efficiency, and capacity and enable support for new vertical segments. Carriers are implementing NFV and SDN to reduce network costs, improve service velocity, and simplify deployment of new services. Such improvements also facilitate cloud RANs that promise further efficiency gains.

5G research and development efforts have accelerated; standards-based deployment will begin in 2019 and continue through 2030. Operators have announced pre-standard fixed-wireless deployments for 2017. 3GPP has implemented a 5G standardization process that began in Release 14 with a study of the new 5G radio, continues now with a first phase of specifications in Release 15 that provides both non-standalone and standalone options, then moves ahead with a second phase of complete specifications in Release 16.

By harnessing new spectrum, such as mmWave bands above 24 GHz, 5G will eventually be able to access ten times as much spectrum as is currently available for cellular operation. Using radio bands 200 MHz or wider will result in multi-Gbps throughput capabilities. 5G will be designed to integrate with LTE networks, and many 5G features may be implemented as LTE-Advanced Pro extensions prior to full 5G availability.

Small cells will play an ever-more-important role in boosting capacity, benefiting from a number of technologies and developments, including SON, eICIC, Dual Connectivity, LWA/LWIP, LTE-U, LTE-LAA, MulteFire, improved backhaul options, and spectrum ideal for small cells, such as the 3.5 GHz and mmWave bands.

Obtaining more spectrum remains a priority globally. In U.S. markets, the recently completed television incentive auctions for 600 MHz spectrum supplied 70 MHz of new licensed spectrum; the 3.5 GHz small-cell band will provide 150 MHz; and the 5G spectrum bands, with both licensed and unlicensed bands, will add about 10 GHz of new spectrum.

The future of mobile broadband, including both LTE-Advanced and 5G, is bright, with no end in sight for continued growth in capability, nor for the limitless application innovation that mobile broadband enables.

Appendix: Technology Details

The 3GPP family of data technologies provides ever increasing capabilities that support ever more demanding applications. Services obviously need to provide broad coverage and high data throughput. Less obvious for users, but as critical for effective application performance, are the need for low latency, QoS control, and spectral efficiency. Higher spectral efficiency translates to higher average throughputs (and thus more responsive applications) for more active users in a coverage area. The discussion below details the progression of capability for each technology, including throughput, security, latency, QoS, and spectral efficiency.

This appendix provides details on 5G, UMTS/HSPA, and EDGE.

3GPP Releases

- ❑ **Release 99:** Completed. First deployable version of UMTS. Enhancements to GSM data (EDGE). Provides support for GSM/EDGE/GPRS/WCDMA radio-access networks.
- ❑ **Release 4:** Completed. Multimedia messaging support. First steps toward using IP transport in the core network.
- ❑ **Release 5:** Completed. HSDPA. First phase of Internet Protocol Multimedia Subsystem (IMS). Full ability to use IP-based transport instead of just Asynchronous Transfer Mode (ATM) in the core network.
- ❑ **Release 6:** Completed. HSUPA. Enhanced multimedia support through Multimedia Broadcast/Multicast Services (MBMS). Performance specifications for advanced receivers. Wireless Local Area Network (WLAN) integration option. IMS enhancements. Initial VoIP capability.
- ❑ **Release 7:** Completed. Provides enhanced GSM data functionality with Evolved EDGE. Specifies HSPA+, which includes higher-order modulation and MIMO. Performance enhancements, improved spectral efficiency, increased capacity, and better resistance to interference. Continuous Packet Connectivity (CPC) enables efficient “always-on” service and enhanced uplink UL VoIP capacity, as well as reductions in call set-up delay for Push-to-Talk Over Cellular (PoC). Radio enhancements to HSPA include 64 Quadrature Amplitude Modulation (QAM) in the downlink and 16 QAM in the uplink. Also includes optimization of MBMS capabilities through the multicast/broadcast, single frequency network (MBSFN) function.
- ❑ **Release 8:** Completed. Comprises further HSPA Evolution features such as simultaneous use of MIMO and 64 QAM. Includes dual-carrier HSDPA (DC-HSDPA) wherein two downlink carriers can be combined for a doubling of throughput performance. Specifies OFDMA-based 3GPP LTE. Defines EPC and EPS.
- ❑ **Release 9:** Completed. HSPA and LTE enhancements including HSPA dual-carrier downlink operation in combination with MIMO, Multimedia Broadcast Multicast Services (MBMS), HSDPA dual-band operation, HSPA dual-carrier uplink operation, EPC enhancements, femtocell support, support for regulatory features such as emergency user equipment positioning and Commercial Mobile Alert System (CMAS), and evolution of IMS architecture.
- ❑ **Release 10:** Completed. Specifies LTE-Advanced that meets the requirements set by ITU’s IMT-Advanced project. Key features include carrier aggregation, multi-antenna enhancements such as enhanced downlink eight-branch MIMO and uplink MIMO, relays,

enhanced LTE Self-Organizing Network capability, Evolved Multimedia Broadcast Multicast Services (eMBMS), HetNet enhancements that include eICIC, Local IP Packet Access, and new frequency bands. For HSPA, includes quad-carrier operation and additional MIMO options. Also includes femtocell enhancements, optimizations for M2M communications, and local IP traffic offload.

- **Release 11:** Completed. For LTE, emphasizes Coordinated Multi Point (CoMP), carrier-aggregation enhancements, devices with interference cancellation, development of the Enhanced Physical Downlink Control Channel (EPDCCH), and further enhanced eICIC including devices with CRS (Cell-specific Reference Signal) interference cancellation. The release includes further DL and UL MIMO enhancements for LTE. For HSPA, provides eight-carrier on the downlink, uplink enhancements to improve latency, dual-antenna beamforming and MIMO, CELL Forward Access Channel (FACH) state enhancement for smartphone-type traffic, four-branch MIMO enhancements and transmissions for HSDPA, 64 QAM in the uplink, downlink multipoint transmission, and noncontiguous HSDPA carrier aggregation. Wi-Fi integration is promoted through S2a Mobility over GPRS Tunneling Protocol (SaMOG). An additional architectural element called “Machine-Type Communications Interworking Function” (MTC-IWF) will more flexibly support machine-to-machine communications.
- **Release 12:** Completed. Enhancements include improved small cells/HetNets for LTE, LTE multi-antenna/site technologies (including Active Antenna Systems), Dual Connectivity, 256 QAM modulation option, further CoMP/MIMO enhancements, enhancements for interworking with Wi-Fi, enhancements for MTC, SON, support for emergency and public safety, Minimization of Drive Tests (MDT), advanced receivers, device-to-device communication (also referred to as Proximity Services), group communication enablers in LTE, addition of Web Real Time Communication (WebRTC) to IMS, energy efficiency, more flexible carrier aggregation, dynamic adaptation of uplink-downlink ratios in TDD mode, further enhancements for HSPA+, small cells/HetNets, Scalable-UMTS, and FDD-TDD carrier aggregation.
- **Release 13:** Completed. LTE features include Active Antenna Systems (AAS) with support for as many as 16 antenna elements (full-dimension MIMO) and beamforming, Network-Assisted Interference Cancellation and Suppression (NAICS), radio-access network sharing, carrier aggregation supporting 32 component carriers,⁹⁷ carrier aggregation of up to four carriers on the downlink and two carriers on the uplink, LAA for operation in unlicensed bands, LTE Wi-Fi Aggregation including LWIP, RCLWI, isolated operation and mission-critical voice communications for public safety, application-specific congestion management, User-Plane Congestion Management, enhancement to WebRTC interoperability, architecture enhancement for dedicated core networks, enhancement to proximity-based services, Mission-Critical Push-to-Talk, group communications, CoMP enhancements, small cell enhancements, machine-type communications enhancements including NB-IoT and Extended Coverage GSM (EC-GSM), VoLTE enhancements, SON enhancements, shared network enhancements, indoor positioning based on WLAN access points, Bluetooth beacons and barometric pressure, and enhanced circuit-switched fallback. HSPA+ features include support for dual-band uplink carrier aggregation.

⁹⁷ This level of aggregation refers to signaling capabilities. The number of carriers that can be combined in an actual deployment is smaller and depends on RAN co-existence studies. Refer to the appendix section on “Carrier Aggregation” for additional details.

- ❑ **Release 14:** Expected completion June 2017. Contemplated features include uplink operation for LAA (enhanced LAA), full-dimension MIMO enhanced with up to 32 antenna elements, dual-connectivity of licensed and unlicensed carriers across non-collocated nodes, vehicle-to-vehicle and vehicle-to-infrastructure (V2X) communications built on Release 12 Proximity Services, shared LTE broadcast in which different operators broadcast the same content on the same frequency, non-IP operation for IoT, Downlink Multi-user Superposition Transmission (MUST), enhanced LWA, VoLTE enhancements, LWIP/LWA enhancements, eMBMS enhancements, NB-IoT enhancements, and LTE latency reduction.
- ❑ **Release 15:** Expected completion September 2018. Non-standalone (using LTE core network) option expected March 2018. Specifies phase 1 of 5G. NR radio, 4G-5G interworking, and MIMO/beamforming. Further LTE enhancements include ultra-reliable low-latency communications, NB-IoT enhancements, LAA enhancements, V2X enhancements, DL 1024 QAM, CoMP enhancements, AAS enhancements, and LTE/5G core network capability.
- ❑ **Release 16:** Expected completion end of 2019. Specifies phase 2 of 5G. Adds URLLC, spectrum sharing, unlicensed spectrum operation and integration, and multiple other enhancements. Further LTE enhancements.

Data Throughput Comparison

Data throughput is an important metric for quantifying network throughput performance. Unfortunately, the ways in which various organizations quote throughputs vary tremendously, often resulting in misleading claims. The intent of this paper is to realistically represent the capabilities of these technologies.

One method of representing a technology's throughput is what people call "peak throughput" or "peak network speed," which refers to the fastest possible transmission speed over the radio link and is generally based on the highest-order modulation available and the least amount of coding (error correction) overhead. Peak network speed is also usually quoted at layer 2 of the radio link. Because of protocol overhead, actual application throughput may be up to 10% lower than this layer-2 value.

Another method is to disclose throughputs actually measured in deployed networks with applications such as File Transfer Protocol (FTP) under favorable conditions, which assume light network load (as low as one active data user in the cell sector) and favorable signal propagation. This number is useful because it demonstrates the high-end, actual capability of the technology in current deployments, referred to in this paper as the "peak user rate." Average rates are lower than this peak rate and are difficult to predict because they depend on a multitude of operational and network factors. Except when the network is congested, however, the majority of users should experience throughput rates higher than one-half of the peak achievable rate.

Some operators, primarily in the United States, also quote typical throughput rates, which are based on throughput tests the operators have done across their operating networks and incorporate a higher level of network load. Although the operators do not disclose the precise methodologies they use to establish these figures, the values provide a good indication of what users can realistically expect.

Table 14 presents the technologies in terms of peak network throughput rates, peak user rates (under favorable conditions), and typical rates. It omits values that are not yet known, such as for future technologies.

The projected typical rates for HSPA+ and LTE show a wide range because these technologies exploit favorable radio conditions to achieve high throughput rates, but under poor radio conditions, throughput rates are lower.

Table 14: Throughput Performance of Different Wireless Technologies (Blue Indicates Theoretical Peak Rates, Green Typical)

	Downlink		Uplink	
	Peak Network Speed	Peak and/or Typical User Rate	Peak Network Speed	Peak and/or Typical User Rate
5G in mmWave, early versions ⁹⁸	5 Gbps	500 Mbps	2 Gbps	250 Mbps
5G in mmWave, later versions	50 Gbps	5 Gbps	25 Gbps	2 Gbps
LTE (2X2 MIMO, 10+10 MHz, DL 64 QAM, UL 16 QAM)	70 Mbps	6.5 to 26.3 Mbps ⁹⁹	35 Mbps ¹⁰⁰	6.0 to 13.0 Mbps
LTE-Advanced (2X2 or 4X4 MIMO, 20+20 MHz or 40+20 MHz with Carrier Aggregation [CA], DL 64 QAM, UL 16 QAM)	300 Mbps	N/A	71 Mbps ¹⁰¹	N/A
LTE Advanced (4X4 MIMO, 60+20MHz, CA, 256 QAM DL, 64 QAM UL)	600 Mbps		150 Mbps	
LTE Advanced (4X4 MIMO, 80+20 MHz, CA, 256 QAM DL, 64 QAM UL)	> 1 Gbps		150 Mbps	

⁹⁸ Speculative values, Rysavy Research estimates. Assumes 200 MHz radio channel, 2:1 TDD. Throughput rates would double using 400 MHz.

⁹⁹ 5G Americas member company analysis for downlink and uplink. Assumes single user with 50% load in other sectors. AT&T and Verizon are quoting typical user rates of 5-12 Mbps on the downlink and 2-5 Mbps on the uplink for their networks. See additional LTE throughput information in the section below, "LTE Throughput."

¹⁰⁰ Assumes 64 QAM. Otherwise 22 Mbps with 16 QAM.

¹⁰¹ Assumes 64 QAM. Otherwise 45 Mbps with 16 QAM.

	Downlink		Uplink	
	Peak Network Speed	Peak and/or Typical User Rate	Peak Network Speed	Peak and/or Typical User Rate
LTE Advanced (8X8 MIMO, 20+20 MHz, DL 64 QAM, UL 64 QAM)	1.2 Gbps	N/A	568 Mbps	N/A
LTE Advanced, 100 MHz + 100 MHz	3 Gbps		1.5 Gbps	
LTE Advanced 32 Carriers	>> 3 Gbps			
EDGE (type 2 MS)	473.6 Kbps	Not Applicable (N/A)	473.6 Kbps	N/A
EDGE (type 1 MS) (Practical Terminal)	236.8 Kbps	200 Kbps peak 160 to 200 Kbps typical ¹⁰²	236.8 Kbps	200 Kbps peak 80 to 160 Kbps typical ¹⁰³
HSDPA Initial Devices (2006)	1.8 Mbps	> 1 Mbps peak	384 Kbps	350 Kbps peak
HSDPA	14.4 Mbps	N/A	384 Kbps	N/A

¹⁰² Assumes four-to-five downlink timeslot devices (each timeslot capable of 40 Kbps).

¹⁰³ Assumes two-to-four uplink timeslot devices (each timeslot capable of 40 Kbps).

	Downlink		Uplink	
	Peak Network Speed	Peak and/or Typical User Rate	Peak Network Speed	Peak and/or Typical User Rate
HSPA¹⁰⁴ Initial Implementation	7.2 Mbps	> 5 Mbps peak 700 Kbps to 1.7 Mbps typical ¹⁰⁵	2 Mbps	> 1.5 Mbps peak 500 Kbps to 1.2 Mbps typical
HSPA	14.4 Mbps	N/A	5.76 Mbps	N/A
HSPA+ (DL 64 QAM, UL 16 QAM, 5+5 MHz)	21.6 Mbps	1.9 Mbps to 8.8 Mbps typical ¹⁰⁶	11.5 Mbps	1 Mbps to 4 Mbps typical
HSPA+ (2X2 MIMO, DL 16 QAM, UL 16 QAM, 5+5 MHz)	28 Mbps	N/A	11.5 Mbps	N/A
HSPA+ (2X2 MIMO, DL 64 QAM, UL 16 QAM, 5+5 MHz)	42 Mbps	N/A	11.5 Mbps	N/A
HSPA+ (DL 64 QAM, UL 16 QAM, Dual Carrier, 10+5 MHz)	42 Mbps	Approximate doubling of 5+5 MHz rates - 3.8 to 17.6 Mbps.	11.5 Mbps	1 Mbps to 4 Mbps typical
HSPA+ (2X2 MIMO DL, DL 64 QAM, UL 16 QAM, Dual Carrier, 10+10 MHz)	84 Mbps	N/A	23 Mbps	N/A

¹⁰⁴ High Speed Packet Access (HSPA) consists of systems supporting both High Speed Downlink Packet Access (HSDPA) and High Speed Uplink Packet Access (HSUPA).

¹⁰⁵ Typical downlink and uplink throughput rates based on AT&T press release, June 4, 2008

¹⁰⁶ 5G Americas member company analysis. Assumes Release 7 with 64 QAM and F-DPCH. Single user. 50% loading in neighboring cells. Higher rates expected with subsequent 3GPP releases.

	Downlink		Uplink	
	Peak Network Speed	Peak and/or Typical User Rate	Peak Network Speed	Peak and/or Typical User Rate
HSPA+ (2X2 MIMO DL, DL 64 QAM, UL 16 QAM, Quad-Carrier, ¹⁰⁷ 20+10 MHz)	168 Mbps	N/A	23 Mbps	N/A
HSPA+ (2X2 MIMO DL and UL, DL 64 QAM, UL 16 QAM, Eight-Carrier, 40+10 MHz)	336 Mbps	N/A	69 Mbps	N/A
HSPA+ (4X2 MIMO DL, 2X2 MIMO UL, DL 64 QAM, UL 16 QAM, 8 carrier, 40+10 MHz)	672 Mbps	N/A	69 Mbps	N/A
EDGE (type 2 MS)	473.6 Kbps	Not Applicable (N/A)	473.6 Kbps	N/A
EDGE (type 1 MS) (Practical Terminal)	236.8 Kbps	200 Kbps peak 160 to 200 Kbps typical ¹⁰⁸	236.8 Kbps	200 Kbps peak 80 to 160 Kbps typical ¹⁰⁹
CDMA2000 EV-DO Rel. 0	2.4 Mbps	> 1 Mbps peak	153 Kbps	150 Kbps peak

¹⁰⁷ No operators have announced plans to deploy HSPA in a quad (or greater) carrier configuration. Three carrier configurations, however, have been deployed.

¹⁰⁸ Assumes four-to-five downlink timeslot devices (each timeslot capable of 40 Kbps).

¹⁰⁹ Assumes two-to-four uplink timeslot devices (each timeslot capable of 40 Kbps).

	Downlink		Uplink	
	Peak Network Speed	Peak and/or Typical User Rate	Peak Network Speed	Peak and/or Typical User Rate
CDMA2000 EV-DO Rev. A	3.1 Mbps	> 1.5 Mbps peak 600 Kbps to 1.4 Mbps typical ¹¹⁰	1.8 Mbps	> 1 Mbps peak 300 to 500 Kbps typical
CDMA2000 EV-DO Rev. B (3 radio channels 5+5 MHz)	14.7 ¹¹¹ Mbps	Proportional increase of Rev A typical rates based on number of carriers.	5.4 Mbps	N/A
CDMA2000 EV-DO Rev B Theoretical (15 radio channels 20+20 MHz)	73.5 Mbps	N/A	27 Mbps	N/A

Additional information about LTE throughput appears below in the section “LTE Throughput.”

Latency Comparison

As important as throughput is network latency, defined as the round-trip time it takes data to traverse the network. Each successive data technology from GPRS forward reduces latency, with LTE networks having latency as low as 15 msec. Ongoing improvements in each technology mean that all of these values will go down as vendors and operators fine-tune their systems. Figure 39 shows the latency of different 3GPP technologies.

¹¹⁰ Typical downlink and uplink throughput rates based on Sprint press release Jan. 30, 2007.

¹¹¹ Assuming use of 64 QAM.

Figure 39: Latency of Different Technologies¹¹²

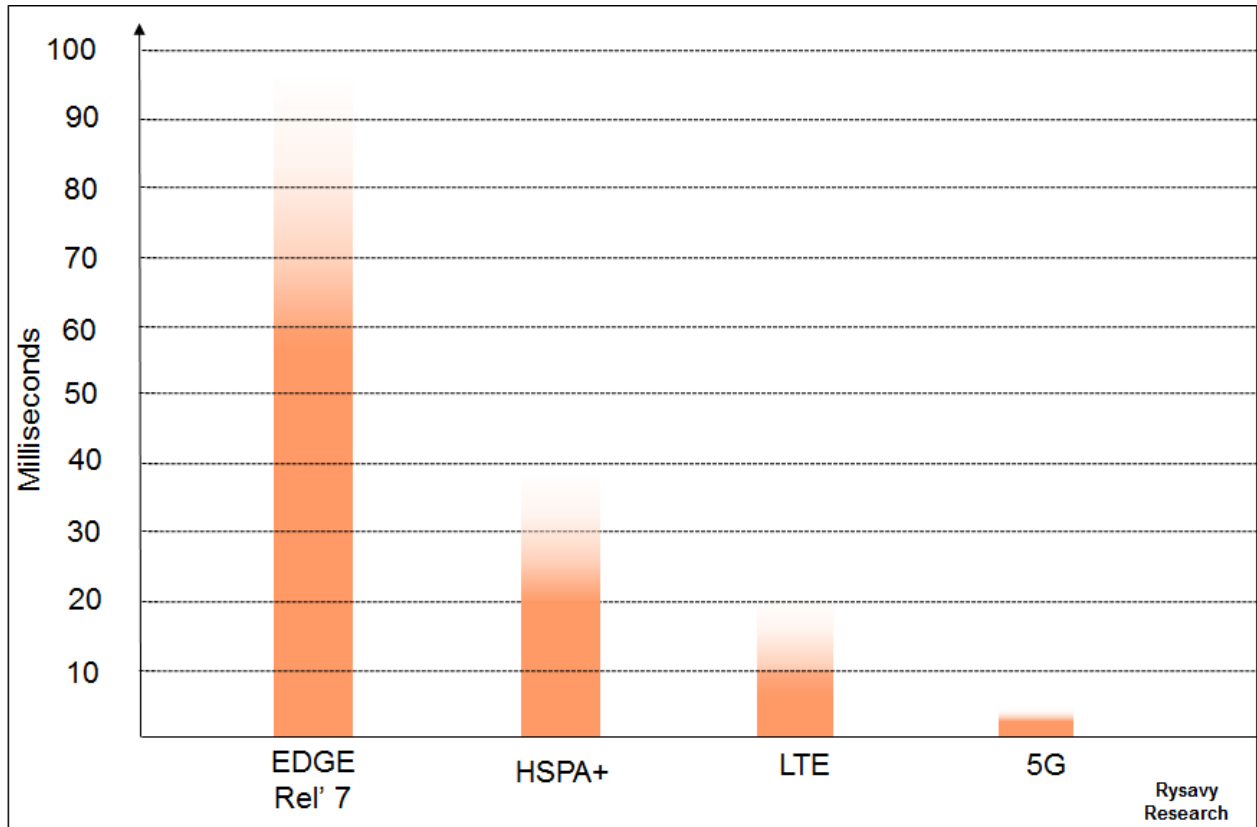

The values shown in Figure 39 reflect measurements of commercially deployed technologies, with EDGE Release 7 achieving 70 to 95 msec, HSPA+ 25 to 30 msec, and LTE 15 to 20 msec. A latency goal for 5G is less than 4 msec for broadband and 0.5 msec for mission-critical applications.

Spectral Efficiency

The evolution of data services is characterized by an increasing number of users with ever-higher bandwidth demands. As the wireless data market grows, deploying wireless technologies with high spectral efficiency is of paramount importance. Keeping all other things equal, including frequency band, amount of spectrum, and cell site spacing, an increase in spectral efficiency translates to a proportional increase in the number of users supported at the same load per user—or, for the same number of users, an increase in throughput available to each user.

Increased spectral efficiency, however, comes at a price because it generally involves greater complexity for both user and base station equipment. Complexity can arise from the increased number of calculations performed to process signals or from additional radio

¹¹² 5G Americas member companies. Measured between subscriber unit and a node immediately external to wireless network. Does not include internet latency. Note that there is some variation in latency based on network configuration and operating conditions.

components. Hence, operators and vendors must balance market needs against network and equipment costs. OFDMA technologies, such as LTE and planned 5G approaches, achieve higher spectral efficiency with lower overall complexity, especially in larger bandwidths.

As shown in Figure 40, the link-layer performance of modern wireless technologies is approaching the theoretical limits as defined by the Shannon bound. (The Shannon bound is a theoretical limit to the information transfer rate [per unit bandwidth] that can be supported by any communications link. The bound is a function of the SNRs of the communications link.) Figure 40 also shows that HSDPA, 1xEV-DO, and IEEE 802.16e-2005 are all within 2 to 3 decibels (dB) of the Shannon bound, indicating that there is not much room for improvement from a link-layer perspective.

Figure 40: Performance Relative to Theoretical Limits for HSDPA, EV-DO, and WiMAX (IEEE 802.16e-2005)¹¹³

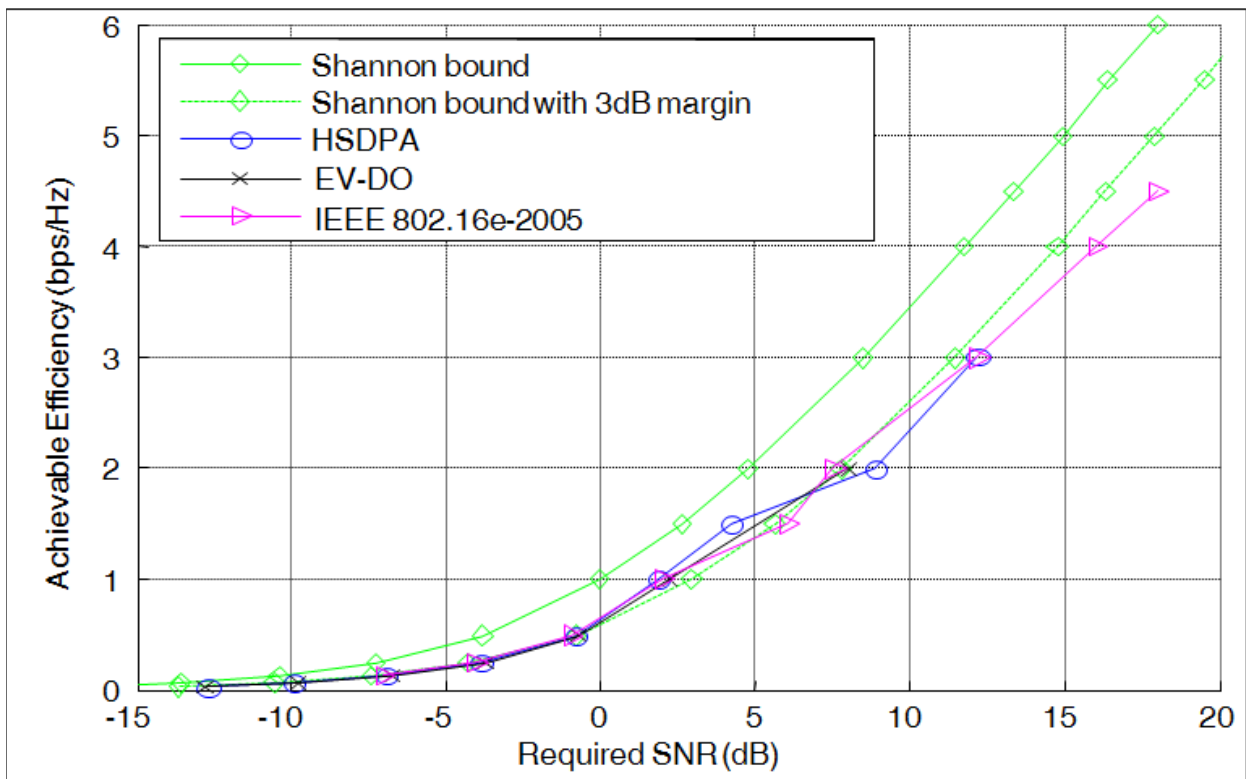

The curves in Figure 40 are for an Additive White Gaussian Noise Channel (AWGN). If the channel is slowly varying and the frame interval is significantly shorter than the coherence time, the effects of fading can be compensated for by practical channel estimation algorithms—thus justifying the AWGN assumption. For instance, at 3 km per hour and fading at 2 GHz, the Doppler spread is about 5.5 Hz. The coherence time of the channel is thus 1 second (sec)/5.5 or 180 msec. Frames are well within the coherence time of the channel, because they are typically 20 msec or less. As such, the channel appears

¹¹³ 5G Americas member contribution.

“constant” over a frame, and the Shannon bound applies. Furthermore, significantly more of the traffic in a cellular system is at slow speeds (for example, 3 km/hr. or less) rather than at higher speeds. The Shannon bound is consequently also relevant for a realistic deployment environment.

As the speed of the mobile station increases and the channel estimation becomes less accurate, additional margin is needed. This additional margin, however, would impact the different standards fairly equally.

The focus of future technology enhancements is on improving system performance aspects that reduce interference to maximize the experienced SNRs in the system and antenna techniques (such as MIMO) that exploit multiple links or steer the beam rather than on investigating new air interfaces that attempt to improve link-layer performance.

MIMO techniques using spatial multiplexing to increase the overall information transfer rate by a factor proportional to the number of transmit or receive antennas do not violate the Shannon bound because the per-antenna transfer rate (that is, the per-communications link transfer rate) is still limited by the Shannon bound.

Figure 41 compares the spectral efficiency of different wireless technologies based on a consensus view of 5G Americas contributors to this paper. It shows the continuing evolution of the capabilities of all the technologies discussed. The values shown are reasonably representative of real-world conditions. Most simulation results produce values under idealized conditions; as such, some of the values shown are lower (for all technologies) than the values indicated in other papers and publications. For instance, 3GPP studies indicate higher HSPA and LTE spectral efficiencies. Nevertheless, there are practical considerations in implementing technologies that can prevent actual deployments from reaching calculated values. Consequently, initial versions of technology may operate at lower levels but then improve over time as designs are optimized. Therefore, readers should interpret the values shown as achievable, but not as the actual values that might be measured in any specific deployed network.

Figure 41: Comparison of Downlink Spectral Efficiency¹¹⁴

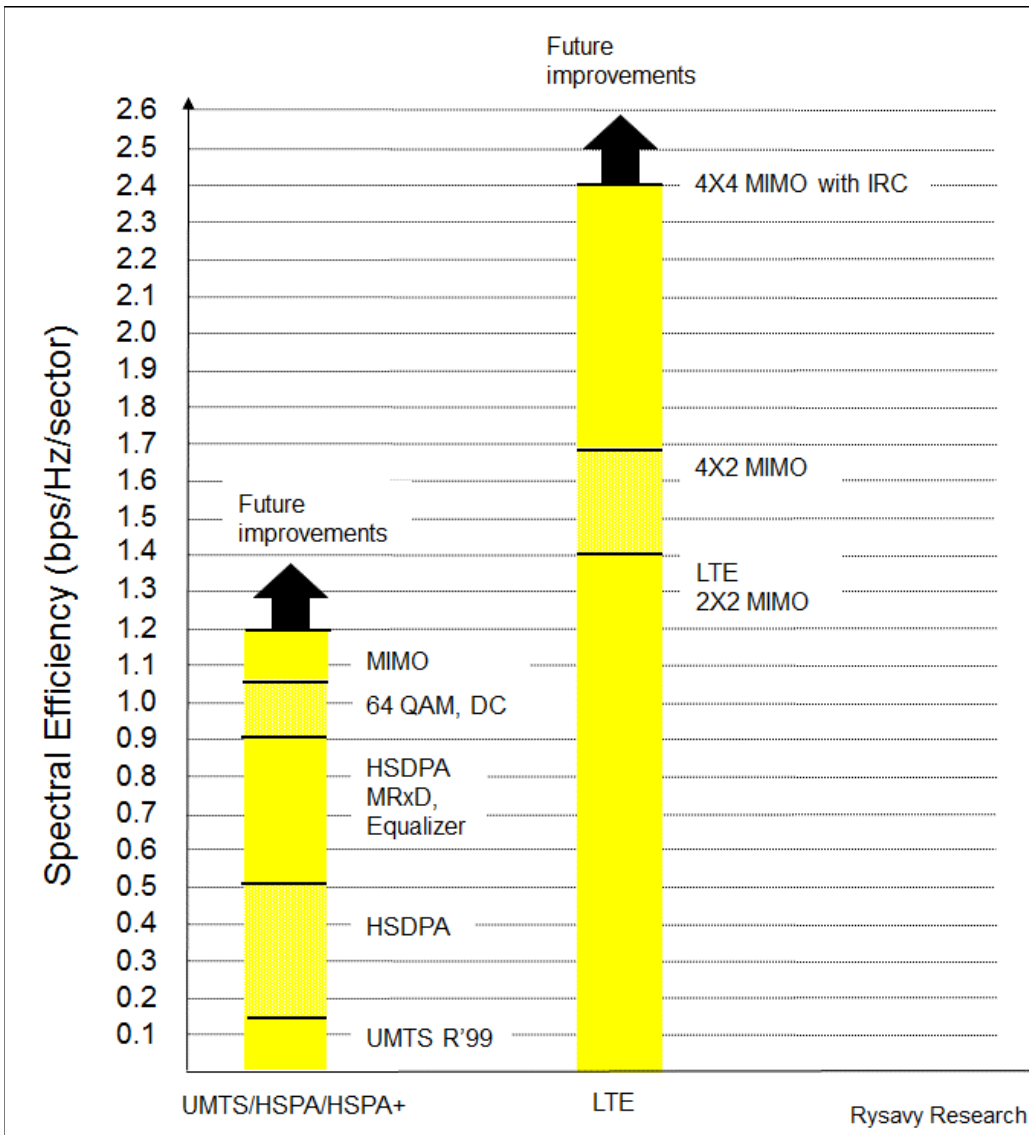

The values shown in Figure 41 are not all possible combinations of available features. Rather, they are representative milestones in ongoing improvements in spectral efficiency. For instance, terminals may employ Mobile Receive Diversity but not equalization.

The figure does not include EDGE, but EDGE itself is spectrally efficient at 0.6 bps/Hz using mobile receive diversity and, potentially, 0.7 bps/Hz with MIMO. Relative to WCDMA Release 99, HSDPA increases capacity by almost a factor of three. Type 3 receivers that include MMSE equalization and Mobile Receive Diversity (MRxD) effectively double HSDPA spectral efficiency. The addition of dual-carrier operation and 64 QAM increases spectral efficiency by about 15%, and MIMO can increase spectral efficiency by another 15%.

¹¹⁴ Joint analysis by 5G Americas members. 5+5 MHz FDD for UMTS-HSPA/LTE. Mix of mobile and stationary users.

reaching 1.2 bps/Hz. Dual-carrier HSPA+ offers a gain in spectral efficiency from cross-carrier scheduling with possible gains of about 10%.¹¹⁵

Some enhancements, such as 64 QAM for HSPA, are simpler to deploy than other enhancements, such as 2X2 MIMO. The former can be done as a software upgrade, whereas the latter requires additional hardware at the base station. Thus, the figure does not necessarily show the actual progression of technologies that operators will deploy to increase spectral efficiency.

Beyond HSPA, 3GPP LTE results in further spectral efficiency gains, initially with 2X2 MIMO, then 4X2 MIMO, and then 4X4 MIMO. The gain for 4X2 MIMO will be 20% more than LTE with 2X2 MIMO; the gain for 4X4 MIMO in combination with interference rejection combining (IRC) will be 70% greater than 2X2 MIMO, reaching 2.4 bps/Hz. This value represents a practical deployment of 4X4 MIMO, with random phase and some timing-alignment error included in each of the four transmit paths. CoMP, discussed below in the appendix, provides a minimal contribution to spectral efficiency.

LTE is even more spectrally efficient when deployed using wider radio channels of 10+10 MHz and 20+20 MHz, although most of the gain is realized at 10+10 MHz. LTE TDD has spectral efficiency that is within 1% or 2% of LTE FDD.¹¹⁶

Figure 42 compares the uplink spectral efficiency of the different systems.

¹¹⁵ 5G Americas member analysis. Vendor estimates for spectral-efficiency gains from dual-carrier operation range from 5% to 20%. Lower spectral efficiency gains are due to full-buffer traffic assumptions. In more realistic operating scenarios, gains will be significantly higher.

¹¹⁶ Assumes best-effort traffic. Performance between LTE-TDD and FDD differs for real-time traffic for the following reasons: a.) The maximum number of HARQ process should be made as small as possible to reduce the packet re-transmission latency. b.) In FDD, the maximum number of HARQ process is fixed and, as such, the re-transmission latency is 7ms. c.) For TDD, the maximum number of HARQ process depends on the DL:UL configurations. As an example, the re-transmission latency for TDD config-1 is 9ms. d.) Because of higher re-transmission latency, the capacity of real-time services cannot be scaled for TDD from FDD based on the DL:UL ratio.

Figure 42: Comparison of Uplink Spectral Efficiency¹¹⁷

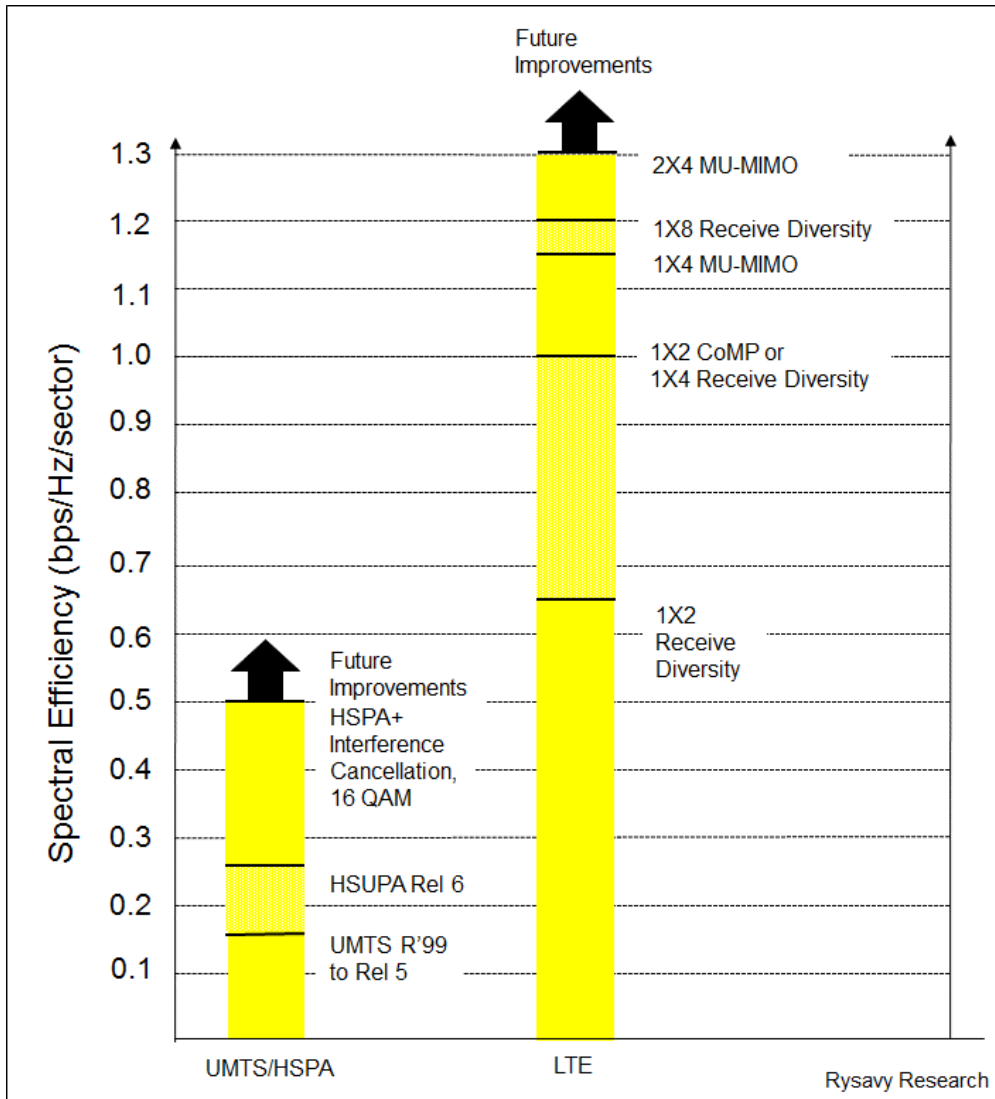

The implementation of HSUPA in HSPA significantly increases uplink capacity.

With LTE, spectral efficiency increases by use of receive diversity. Initial systems will employ 1X2 receive diversity (two antennas at the base station). 1X4 diversity will increase spectral efficiency by 50%, to 1.0 bps/Hz, and 1X8 diversity will provide a further 20% increase, from 1.0 bps/Hz to 1.2 bps/Hz.

It is also possible to employ Multi-User MIMO (MU-MIMO), which allows simultaneous transmission by multiple users on the same physical uplink resource to increase spectral efficiency. MU-MIMO will provide a 15% to 20% spectral efficiency gain, with actual increases depending on how well link adaptation is implemented. The figure uses a conservative 15% gain, showing MU-MIMO with a 1X4 antenna configuration increasing

¹¹⁷ Joint analysis by 5G Americas members. 5+5 MHz for UMTS-HSPA/LTE. Mix of mobile and stationary users.

spectral efficiency by 15%, to 1.15 bps/Hz, and 2X4 MU-MIMO a further 15%, to 1.3 bps/Hz.

In Release 11, uplink CoMP using 1X2 increases efficiency from .65 bps/Hz to 1.0 bps/Hz. Many of the techniques used to improve LTE spectral efficiency can also be applied to HSPA since they are independent of the radio interface.

Figure 43 compares voice spectral efficiency.

Figure 43: Comparison of Voice Spectral Efficiency¹¹⁸

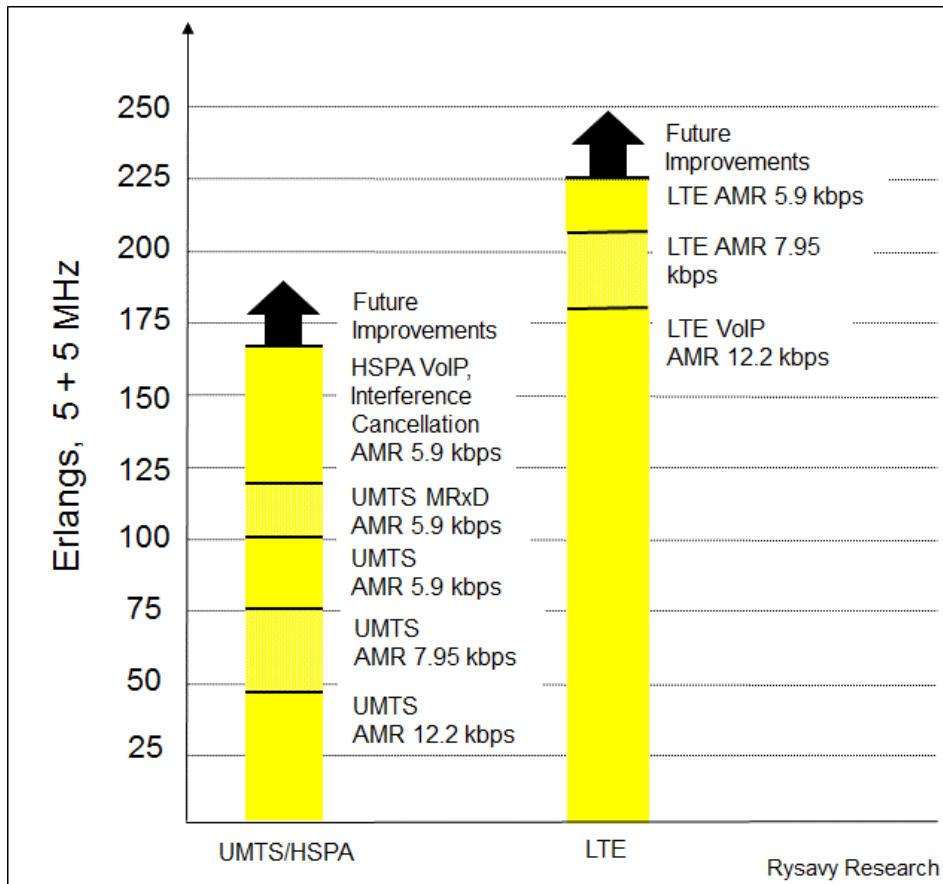

Figure 43 shows UMTS Release 99 with AMR 12.2 Kbps, 7.95 Kbps, and 5.9 Kbps vocoders. The AMR 12.2 Kbps vocoder provides superior voice quality in good (for example, static and indoor) channel conditions.

UMTS has dynamic adaptation between vocoder rates, enabling enhanced voice quality compared with EVRC at the expense of capacity in situations that are not capacity limited. With the addition of mobile receive diversity, UMTS circuit-switched voice capacity could reach 120 Erlangs in 5+5 MHz.

¹¹⁸ Joint analysis by 5G Americas members. 5 + 5 MHz for UMTS-HSPA/LTE. Mix of mobile and stationary users.

VoIP Erlangs in this paper are defined as the average number of concurrent VoIP users that can be supported over a defined period of time (often one hour) assuming a Poisson arrival process and meeting a specified outage criteria (often less than 2% of the users exhibiting greater than 1% frame-error rate). Depending on the specific enhancements implemented, voice capacity could double over existing circuit-switched systems. These gains do not derive through use of VoIP, but rather from advances in radio techniques applied to the data channels. Many of these same advances may also be applied to current circuit-switched modes.

LTE achieves very high voice spectral efficiency because of better uplink performance since there is no in-cell interference. The figure shows LTE VoIP spectral efficiency using AMR at 12.2 Kbps, 7.95 Kbps, and 5.9 Kbps.

VoIP for LTE can use a variety of codecs. The figures show performance assuming specific codecs at representative bit rates. For Enhanced Variable Rate Codecs (EVRCs), the figure shows the average bit rate.

The voice efficiency of the wideband AMR voice codec, operating at 12.65 Kbps, is similar to the AMR codec at 12.2 Kbps, with a value of 180 Erlangs for both since both codecs operate at approximately the same bit rate. 1xRTT has voice capacity of 85 Erlangs in 5+5 MHz with EVRC-A and reaches voice capacity of 120 Erlangs with the use of Quasi-Linear Interference Cancellation (QLIC) and EVRC-B at 6 Kbps.

Data Consumed by Streaming and Virtual Reality

Table 15 quantifies usage based on advanced video compression schemes such as H.264 and H.265, the type of application, and usage per day.

Table 15: Data Consumed by Streaming and Virtual Reality¹¹⁹

Application	Throughput (Mbps)	MByte/hour	Hrs./day	GB/month
Audio or Music	0.1	58	0.5	0.9
			1.0	1.7
			2.0	3.5
			4.0	6.9
Small Screen Video (e.g., Feature Phone)	0.2	90	0.5	1.4
			1.0	2.7
			2.0	5.4
			4.0	10.8
Medium Screen Video (e.g., Smartphone, Tablet, Laptop)	1.0	450	0.5	6.8
			1.0	13.5
			2.0	27.0
			4.0	54.0
Larger Screen Video (e.g., 720p medium definition)	3.0	1350	0.5	20.3
			1.0	40.5
			2.0	81.0
			4.0	162.0
High Definition (e.g., 1080p Netflix HD)	5.0	2250	0.5	33.8
			1.0	67.5
			2.0	135
			4.0	270
4K Ultra-High Definition (Rates will range 12 to 30 Mbps)	20.0	9000	0.5	135
			1.0	270
			2.0	540
			4.0	1080
4G, 30 FPS, Virtual Reality (Rates will range 10 to 50 Mbps)	25.0	11250	0.5	169
			1.0	338
			2.0	675
			4.0	1350
8K, 90 FPS, Virtual Reality (Rates will exceed 200 Mbps)	200.0	90000	0.5	1350
			1.0	2700
			2.0	5400
			4.0	10800
6 Degrees Freedom VR (Rates will range 200 to 1,000 Mbps)	500.0	225000	0.5	3375
			1.0	6750
			2.0	13500
			4.0	27000

Rysavy Research

¹¹⁹ Rysavy Research analysis. For virtual reality-data requirements, refer to ABI Research/Qualcomm, *Augmented and Virtual Reality: the First Wave of 5G Killer Apps*, 2017. See also Netflix discussion of usage, "How can I control how much data Netflix uses?" <https://help.netflix.com/en/node/87>. Viewed May 3, 2016.

Spectrum Bands

3GPP technologies operate in a wide range of radio bands. As new spectrum becomes available, 3GPP updates its specifications for these bands. Although the support of a new frequency band may be introduced in a particular release, 3GPP specifies ways to implement devices and infrastructure operating on any frequency band, according to releases previous to the introduction of that particular frequency band. For example, although band 5 (US Cellular Band) was introduced in Release 6, the first devices operating on this band were compliant with the release 5 of the standard.

Table 16 shows the UMTS FDD bands.

Table 16: UMTS FDD Bands¹²⁰

Operating Band	UL Frequencies UE Transmit, Node B Receive	DL Frequencies UE Receive, Node B Transmit
I	1920 - 1980 MHz	2110 -2170 MHz
II	1850 -1910 MHz	1930 -1990 MHz
III	1710-1785 MHz	1805-1880 MHz
IV	1710-1755 MHz	2110-2155 MHz
V	824 - 849MHz	869-894MHz
VI	830-840 MHz	875-885 MHz
VII	2500 - 2570 MHz	2620 - 2690 MHz
VIII	880 - 915 MHz	925 - 960 MHz
IX	1749.9 - 1784.9 MHz	1844.9 - 1879.9 MHz
X	1710-1770 MHz	2110-2170 MHz
XI	1427.9 - 1447.9 MHz	1475.9 - 1495.9 MHz
XII	699 - 716 MHz	729 - 746 MHz
XIII	777 - 787 MHz	746 - 756 MHz
XIV	788 - 798 MHz	758 - 768 MHz
XV	Reserved	Reserved
XVI	Reserved	Reserved
XVII	Reserved	Reserved
XVIII	Reserved	Reserved
XIX	830 – 845 MHz	875 -890 MHz
XX	832 - 862 MHz	791 - 821 MHz
XXI	1447.9 - 1462.9 MHz	1495.9 - 1510.9 MHz
XXII	3410 – 3490 MHz	3510 – 3590 MHz
XXV	1850 -1915 MHz	1930 -1995 MHz
XXVI	814-849 MHz	859-894 MHz
XXXII (NOTE 1)	N/A	1452 – 1496 MHz
NOTE 1: Restricted to UTRA operation when dual-band is configured (e.g., DB-DC-HSDPA or dual band 4C-HSDPA). The down link frequenc(ies) of this band are paired with the uplink frequenc(ies) of the other FDD band (external) of the dual band configuration.		

¹²⁰ 3GPP, *Base Station (BS) radio transmission and reception (FDD) (Release 14)*, December 2016, Technical Specification 25.104, V14.1.0.

Universal Mobile Telecommunications System (UMTS) Time Division Duplex (TDD) bands are the same as the LTE TDD bands. Table 17 details the LTE Frequency Division Duplex (FDD) and TDD bands.

Table 17: LTE FDD and TDD bands¹²¹

E-UTRA Operating Band	Uplink (UL) operating band BS receive UE transmit	Downlink (DL) operating band BS transmit UE receive	Duplex Mode
	F _{UL, low} – F _{UL, high}	F _{DL, low} – F _{DL, high}	
1	1920 MHz – 1980 MHz	2110 MHz – 2170 MHz	FDD
2	1850 MHz – 1910 MHz	1930 MHz – 1990 MHz	FDD
3	1710 MHz – 1785 MHz	1805 MHz – 1880 MHz	FDD
4	1710 MHz – 1755 MHz	2110 MHz – 2155 MHz	FDD
5	824 MHz – 849 MHz	869 MHz – 894 MHz	FDD
6 (NOTE 1)	830 MHz – 840 MHz	875 MHz – 885 MHz	FDD
7	2500 MHz – 2570 MHz	2620 MHz – 2690 MHz	FDD
8	880 MHz – 915 MHz	925 MHz – 960 MHz	FDD
9	1749.9 MHz – 1784.9 MHz	1844.9 MHz – 1879.9 MHz	FDD
10	1710 MHz – 1770 MHz	2110 MHz – 2170 MHz	FDD
11	1427.9 MHz – 1447.9 MHz	1475.9 MHz – 1495.9 MHz	FDD
12	699 MHz – 716 MHz	729 MHz – 746 MHz	FDD
13	777 MHz – 787 MHz	746 MHz – 756 MHz	FDD
14	798 MHz – 798 MHz	758 MHz – 768 MHz	FDD
15	Reserved	Reserved	FDD
16	Reserved	Reserved	FDD
17	704 MHz – 716 MHz	734 MHz – 746 MHz	FDD
18	815 MHz – 830 MHz	860 MHz – 875 MHz	FDD
19	830 MHz – 845 MHz	875 MHz – 890 MHz	FDD
20	832 MHz – 862 MHz	791 MHz – 821 MHz	
21	1447.9 MHz – 1462.9 MHz	1495.9 MHz – 1510.9 MHz	FDD
22	3410 MHz – 3490 MHz	3510 MHz – 3590 MHz	FDD
23 ¹	2000 MHz – 2020 MHz	2180 MHz – 2200 MHz	FDD
24	1626.5 MHz – 1680.5 MHz	1525 MHz – 1559 MHz	FDD
25	1850 MHz – 1915 MHz	1930 MHz – 1995 MHz	FDD
26	814 MHz – 849 MHz	859 MHz – 894 MHz	FDD
27	807 MHz – 824 MHz	852 MHz – 869 MHz	FDD
28	703 MHz – 748 MHz	758 MHz – 803 MHz	FDD
29	N/A	717 MHz – 728 MHz	FDD (NOTE 2)
30	2305 MHz – 2315 MHz	2350 MHz – 2360 MHz	FDD
31	452.5 MHz – 457.5 MHz	462.5 MHz – 467.5 MHz	FDD
32	N/A	1452 MHz – 1496 MHz	FDD (NOTE 2)
33	1900 MHz – 1920 MHz	1900 MHz – 1920 MHz	TDD
34	2010 MHz – 2025 MHz	2010 MHz – 2025 MHz	TDD
35	1850 MHz – 1910 MHz	1850 MHz – 1910 MHz	TDD
36	1930 MHz – 1990 MHz	1930 MHz – 1990 MHz	TDD
37	1910 MHz – 1930 MHz	1910 MHz – 1930 MHz	TDD
38	2570 MHz – 2620 MHz	2570 MHz – 2620 MHz	TDD
39	1880 MHz – 1920 MHz	1880 MHz – 1920 MHz	TDD
40	2300 MHz – 2400 MHz	2300 MHz – 2400 MHz	TDD
41	2496 MHz – 2690 MHz	2496 MHz – 2690 MHz	TDD
42	3400 MHz – 3600 MHz	3400 MHz – 3600 MHz	TDD
43	3600 MHz – 3800 MHz	3600 MHz – 3800 MHz	TDD
44	703 MHz – 803 MHz	703 MHz – 803 MHz	TDD
45	1447 MHz – 1467 MHz	1447 MHz – 1467 MHz	TDD
46	5150 MHz – 5925 MHz	5150 MHz – 5925 MHz	TDD (NOTE 3, NOTE 4)
47	5855 MHz – 5925 MHz	5855 MHz – 5925 MHz	TDD (NOTE 7)
48	3550 MHz – 3700 MHz	3550 MHz – 3700 MHz	TDD
65	1920 MHz – 2010 MHz	2110 MHz – 2200 MHz	FDD
66	1710 MHz – 1780 MHz	2110 MHz – 2200 MHz	FDD (NOTE 5)
67	N/A	738 MHz – 758 MHz	FDD (NOTE 2)
68	698 MHz – 728 MHz	753 MHz – 783 MHz	FDD
69	N/A	2570 MHz – 2620 MHz	FDD (NOTE 2)
70	1695 MHz – 1710 MHz	1995 MHz – 2020 MHz	FDD ⁶

NOTE 1: Band 6, 23 are not applicable.
NOTE 2: Restricted to E-UTRA operation when carrier aggregation is configured. The downlink operating band is paired with the uplink operating band (external) of the carrier aggregation configuration that is supporting the configured Pcell.
NOTE 3: This band is an unlicensed band restricted to licensed-assisted operation using Frame Structure Type 3.
NOTE 4: Band 46 is divided into four sub-bands as in Table 5.5-1A.
NOTE 5: The range 2180 – 2200 MHz of the DL operating band is restricted to E-UTRA operation when carrier aggregation is configured.
NOTE 6: The range 2010-2020 MHz of the DL operating band is restricted to E-UTRA operation when carrier aggregation is configured and TX-RX separation is 300 MHz. The range 2005-2020 MHz of the DL operating band is restricted to E-UTRA operation when carrier aggregation is configured and TX-RX separation is 295 MHz.
NOTE 7: No BS requirement is defined for this band.

5G

This section provides early details on aspects of 5G, including architecture, LTE-NR coexistence, integrated access and backhaul, and performance.

Architecture

The overall 5G architecture consists of what 3GPP calls the New Generation Radio-Access Network (NG-RAN) and the 5G Core (5GC), as shown in Figure 44. The figure shows the Access and Mobility Management Function (AMF); the User Plane Function (UPF); the NR NodeB (gNB), which is the 5G base station; and the NG and Xn interfaces.

Figure 44: 5G Architecture¹²²

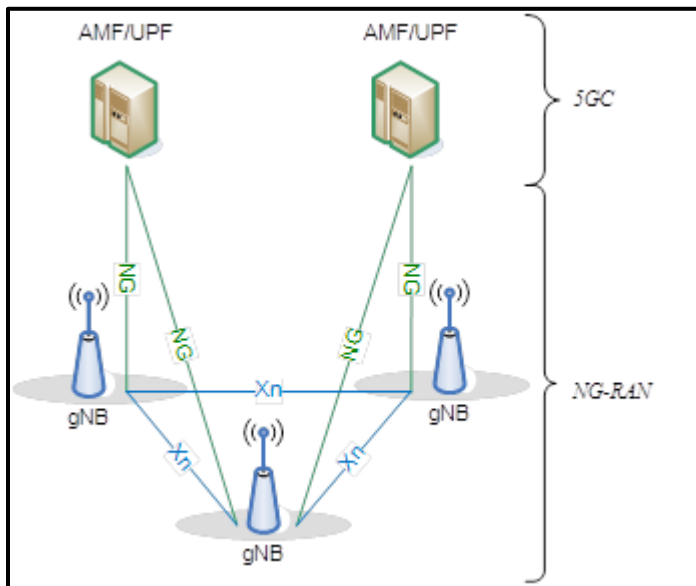
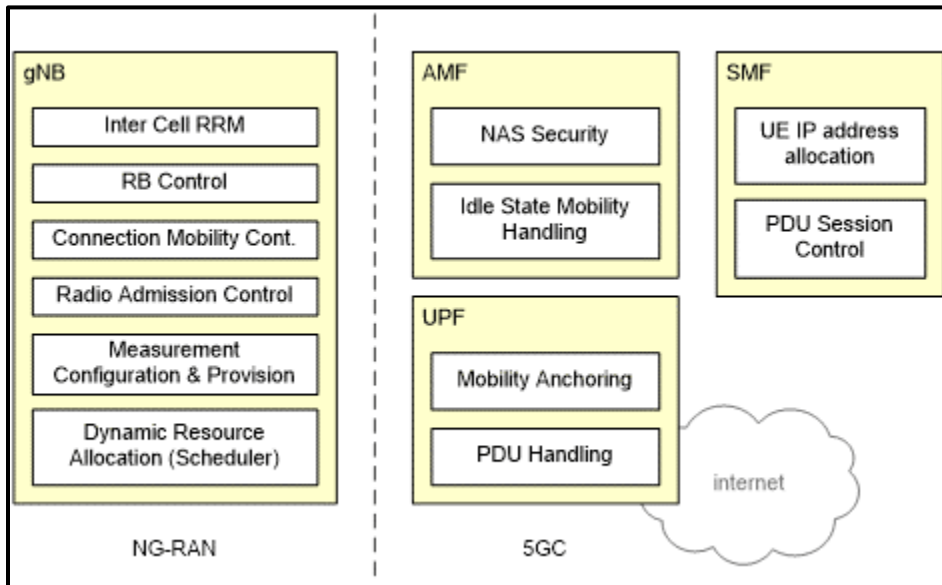

Figure 45 shows the functional split between the NG-RAN and 5GC.

¹²¹ 3GPP, *Evolved Universal Terrestrial Radio Access (E-UTRA); Base Station (BS) radio transmission and reception (Release 14)*, March 2017, Technical Specification 36.104, V14.3.0.

¹²² 3GPP, *3GPP TS 38.300, NR; NR and NG-RAN Overall Description; Stage 2 (Release 15), V0.3.0 (2017-05)*.

Figure 45: Functional Split between NG-RAN and 5G¹²³



The main body of this paper summarizes the features being specified in Releases 15 and 16 for NR and the core network. Additional capabilities that will be part of Release 15 include:

- ❑ A PDCP packet duplication function to allow redundant transmission of signaling or user data on two bearer paths.
- ❑ A new protocol layer called Service Data Adaptation Protocol (SDAP) that offers 5G QoS flows.
- ❑ A new Radio Resource Control (RRC) inactive state designed for low-latency communications.
- ❑ A new system information broadcast model that allows on-demand system information instead of always having to broadcast system information (to reduce overhead in 5G beam sweeping).

Architecture Options

This topic was introduced in the main part of the paper and is covered here in more detail. In Release 15, 3GPP defines a number of different architecture options, shown in the following three figures. In many of these options, although not all, the 5G network integrates with LTE.

¹²³ Ibid.

Figure 46: 5G Network Architecture Options in 3GPP Release 15¹²⁴

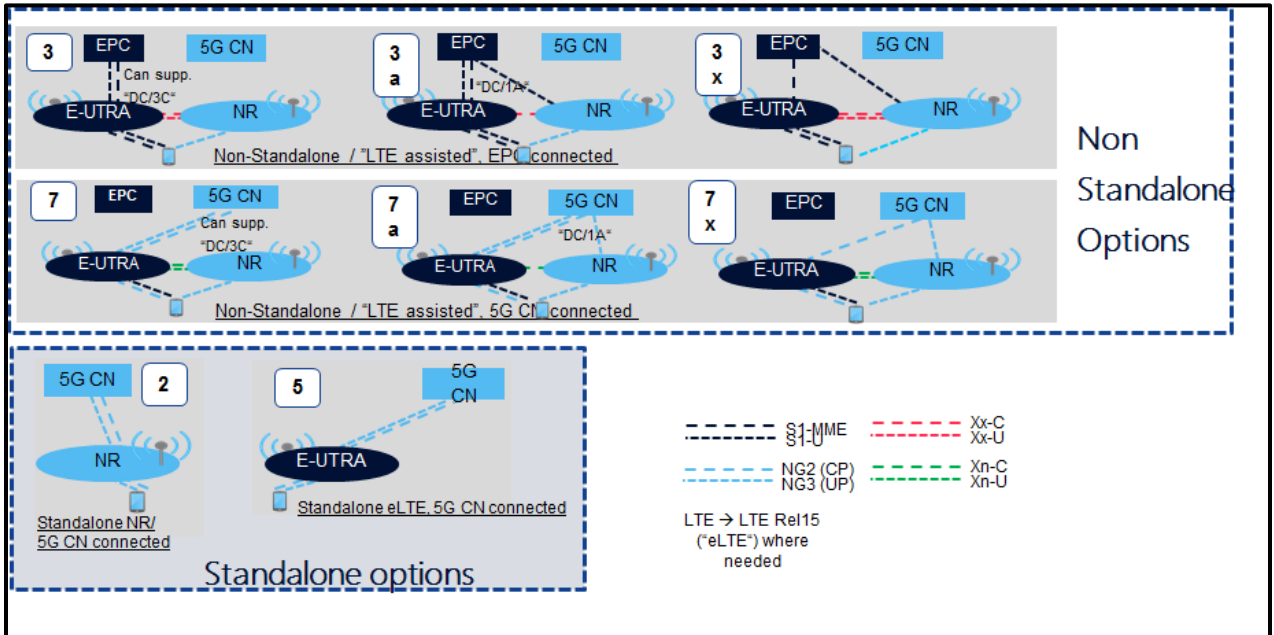
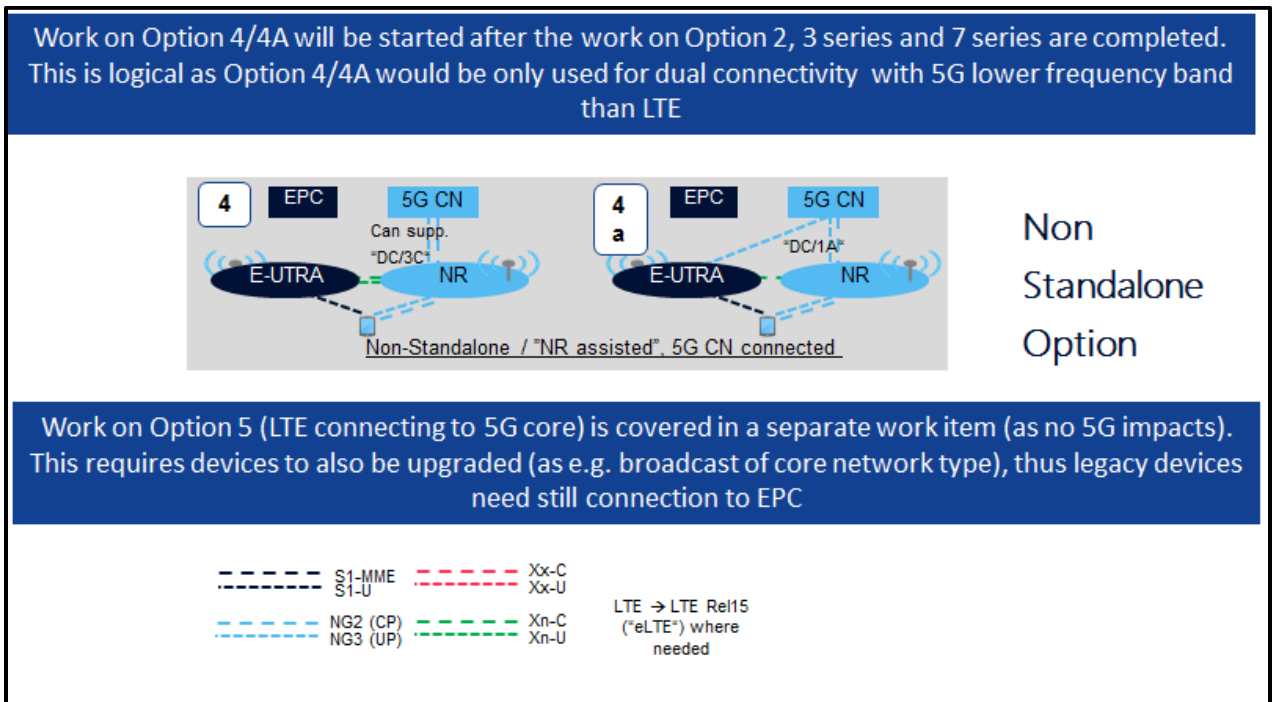
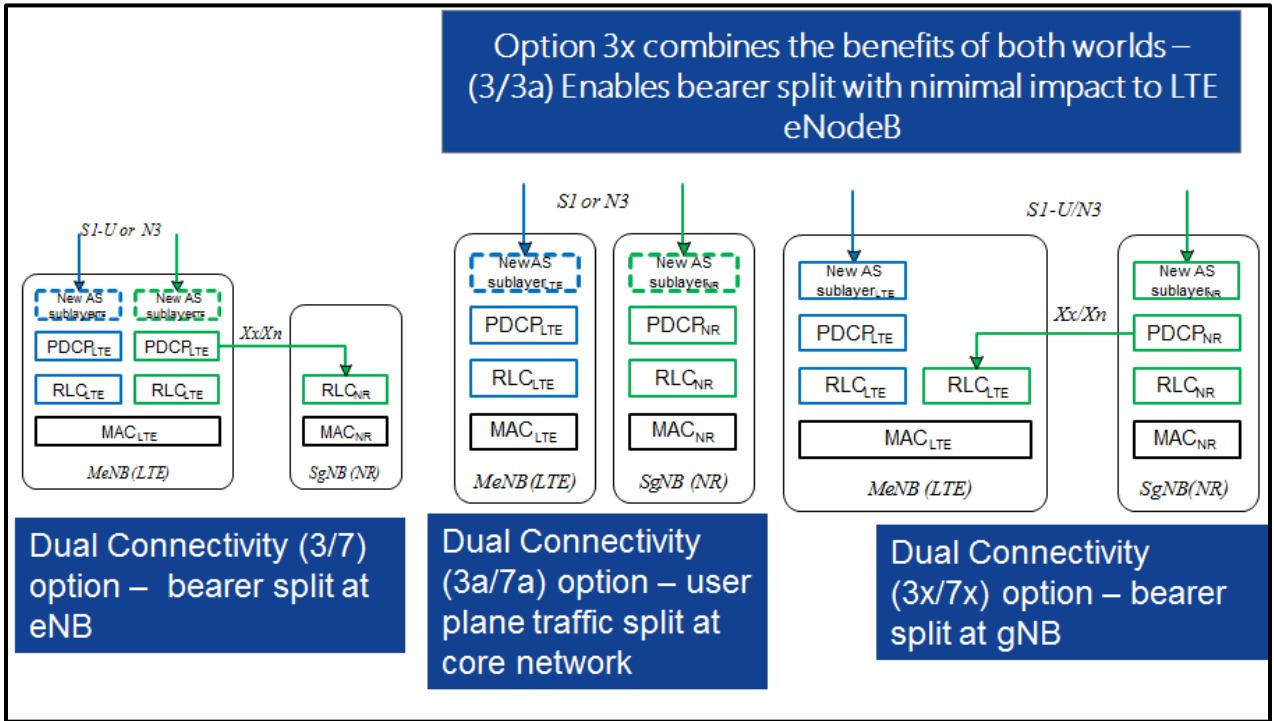

Figure 47: De-Prioritized 5G Network Architecture Options in 3GPP Release 15



¹²⁴ Nokia contribution, including subsequent two figures. For further details, refer to section 7.2, "5G Architecture Options," 3GPP TR 38.801, "Radio access architecture and interfaces."

Figure 48: Dual-Connectivity Options with LTE as Master



LTE-NR Coexistence

LTE-NR coexistence is a Release 15 work item. This section describes how such coexistence may be achieved. Different LTE-NR co-existence cases include the following: time domain LTE/NR adjacent channel coexistence; LTE Secondary Cell on/off for LTE/NR adaptation; in-carrier LTE+NR coexistence in downlink, and in-carrier LTE+NR coexistence in uplink.

NR coexistence is required for LTE UEs of all releases. Because carrier aggregation was not introduced into LTE until LTE Release 10, CA-based techniques cannot be used as the sole means to achieve LTE/NR coexistence. However, CA techniques can be used for both time domain coexistence and frequency domain coexistence. For time domain coexistence, on a given carrier, LTE and NR are time-multiplexed by means of Secondary Cell (SCell) activation or deactivation. For frequency domain coexistence, the network configures a carrier, such as a 20MHz carrier, into multiple carriers, with, for example, 10MHz allocated to LTE and the remaining 10MHz to NR. Note that frequency domain coexistence can be accomplished without using carrier aggregation.

Figure 49 illustrates the frequency domain technique. Note that when splitting the 20MHz carrier into two allocations of 10MHz, the LTE carrier remains centered at the same frequency and the NR allocation is not consecutive.

Figure 49: Frequency Domain Coexistence of LTE and NR¹²⁵

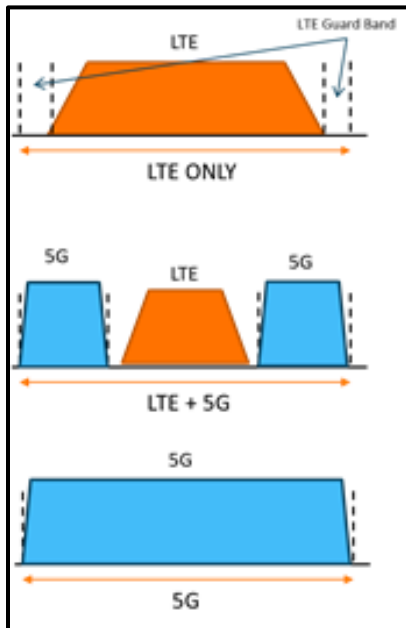

Time Domain LTE/NR Coexistence Techniques

Time domain coexistence of LTE and NR can be dynamic (subframe level) or semi-static (MAC/RRC). In the latter case, spectrum resources are configured as SCell for a LTE UE, and the network can turn these resources on or off by means of SCell activation or deactivation using MAC control elements or by adding and removing the SCell via RRC signaling. Whenever the SCell is deactivated or not configured, the spectrum resources can be used for NR transmissions. In LTE Rel. 12, small-cell enhancements were introduced that allow a UE to measure discovery reference signals (DRS) on a deactivated SCell. In that case, further coordination between LTE and NR may be required even when the SCell is deactivated, as DRS may still be transmitted periodically. Generally, though, this kind of coexistence can be achieved by network implementation.

For the case of dynamic coexistence, LTE and NR co-exist in the same spectrum, and the network can multiplex the two on a subframe level. Because LTE transmits Cell-Specific Reference Signals (CRS) in all DL subframes and in the Downlink Pilot Time Slot (DwPTS) and non-Multicast-Broadcast Single-Frequency network (non-MBSFN) region of special and MBSFN subframes, respectively, dynamic coexistence is not as straightforward as semi-static coexistence.

Similar to the case of time domain coexistence based on CA techniques, whenever OFDM symbols do not carry CRS, coexistence can be achieved by a gNB scheduler implementation. In particular, the gNB can schedule mini-slot-based transmissions in the Uplink Pilot Time Slot (UpPTS) region of a special subframe and in the MBSFN region of an MBSFN subframe, neither of which carry CRS. In LTE UL subframes, the gNB can schedule NR transmissions using either slots or mini-slots. For example, when Sounding Reference Signal (SRS) is transmitted at the end of a subframe, all 14 OFDM symbols may not be available for NR, and mini-slots can be used. Otherwise, slots can be used to transmit NR

¹²⁵ AT&T contribution, including explanatory text.

signals and channels in LTE UL subframes. Even in normal downlink subframes, mini-slots could be used to transmit NR channels and signals on OFDM symbols not carrying CRS. This, however, may leave almost half the resources of a normal DL subframe unusable for NR, so other techniques may be preferable. For example, symbols carrying CRS could also puncture NR transmissions, similar to URLLC transmissions that pre-empt NR transmissions. The same mechanisms specified for eMBB/URLLC coexistence could be used for LTE/NR coexistence.

Frequency Domain LTE/NR Coexistence Techniques

Frequency domain coexistence between LTE and NR can also be dynamic or semi-static. Semi-static FDM-based coexistence is illustrated in Figure 49. Dynamic frequency domain coexistence is possible when the (e/g) NB schedules both LTE and NR in the same subframe on a Physical Resource Block (PRB) level.

There also exists the possibility of mixing semi-static and dynamic schemes as well as time division multiplexing (TDM)- and frequency division multiplexing (FDM)-based schemes based on the duplex direction. UL resources could be dynamically shared in a TDM fashion, whereas DL resources would be semi-statically configured and frequency division multiplexed between LTE and NR. For example, LTE could operate in paired spectrum, and NR could use LTE UL resources for NR UL transmissions but be configured with a separate DL or dynamic TDD carrier, such as at a higher frequency band. In this scenario, the LTE DL would be semi-statically frequency division multiplexed with NR, but LTE UL resources would need to be dynamically shared between LTE and NR. The semi-statically frequency division multiplexed NR resources could be for DL only or for both DL and UL. For example, it could be beneficial to allow for NR SRS transmissions on the frequency division multiplexed NR-only carrier.

Several issues need to be addressed for the shared LTE UL carrier. For example, if the non-shared NR carrier operates in mmWave spectrum while the shared NR/LTE carrier operates below 6GHz, the UE does not receive NR DL signals that can be used for power control and timing advance of the NR UL transmissions in the shared LTE UL resources. In this case, NR signals may have to be sent in the LTE-only DL resources or, alternatively, the NR-only UE needs to receive and process LTE signals in the LTE-only DL carrier. To avoid NR UEs processing LTE signals or LTE eNBs transmitting NR signals, 3GPP will need to investigate whether the aforementioned problem could be solved by signaling mechanisms. Regardless, further studies are needed to address these issues.

Coordination Requirements for LTE/NR Coexistence

While semi-static techniques identified for coexistence may require minimal coordination, dynamic (for example, per-TTI) sharing can be done by coordinating the LTE and NR transmissions via three different mechanisms:

1. Co-locating the NR and LTE scheduling.
2. Via the X2 interface (or the evolved version of the X2 interface in the new RAN architecture).
3. Over-the-air.

Options 1 and 2 do not impact any RAN1 specification, whereas Option 3 requires RAN1 specifications. Also, over-the-air coordination is desirable because it does not require LTE and NR scheduling and transmission to be handled by a single eNodeB, nor does it require an ultra-low-latency transport between them, thereby providing much more deployment

flexibility. This can even allow NR and LTE to be deployed on different tiers (for example, macro and pico) and share the same channel.

Integrated Access and Backhaul

A study item for Release 15 with the likelihood of standardization in Release 16 is integrated access and backhaul, with which the 5G radio can provide both access and backhaul functions, as shown in Figure 50.

Figure 50: 5G Integrated Access and Backhaul

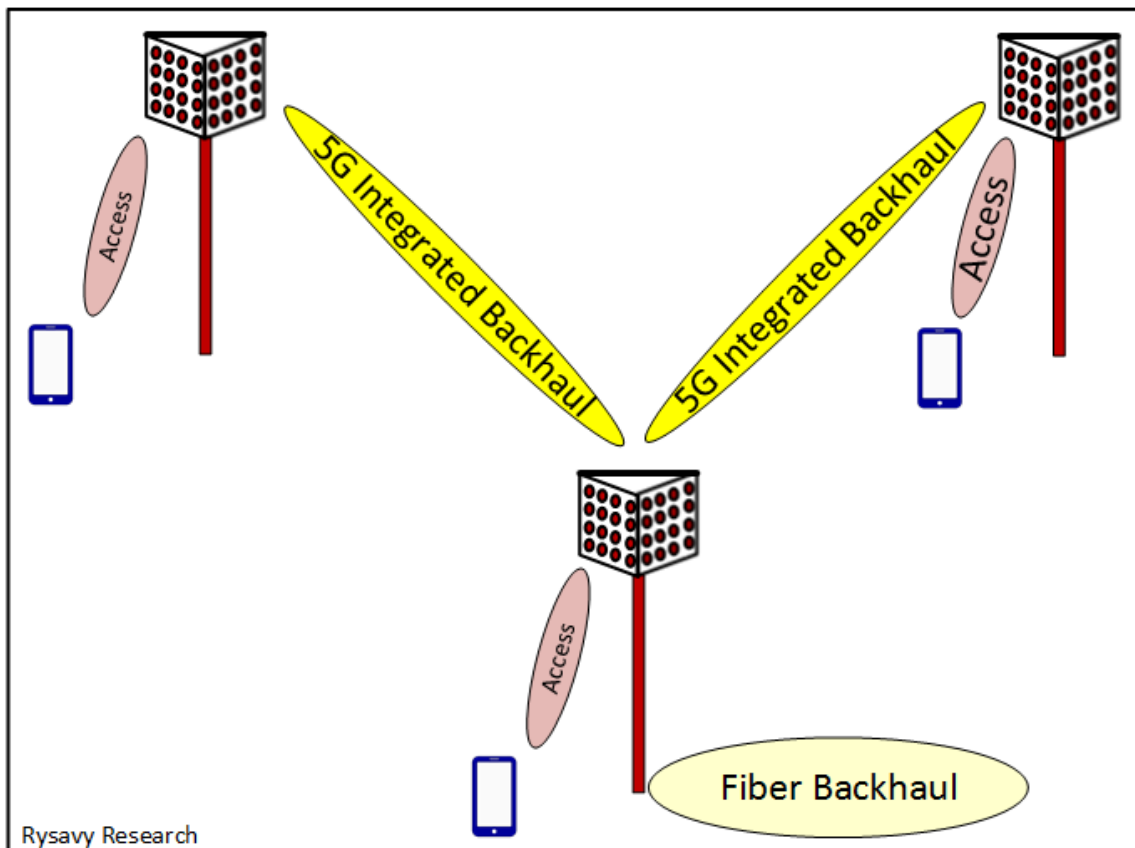

This 3GPP Study item, which has not yet begun, could address the following capabilities:¹²⁶

- ❑ Wireless backhaul using 5G or LTE.
- ❑ Both indoor and outdoor scenarios.
- ❑ Flexible partitioning between access and backhaul functions.
- ❑ Autonomous configuration of access and wireless self-backhaul functions.
- ❑ Multi-hop wireless self-backhauling to enable flexible extension of range and coverage area.

¹²⁶ 3GPP, "Study on Integrated Access and Backhaul for NR," RP-170831, March 2017.

- ❑ Autonomous adaptation on wireless self-backhaul to minimize service disruptions.
- ❑ Topological redundant connectivity on the wireless self-backhaul to enhance reliability and capacity and to reduce latency.

Performance

5G, with the ability to use wider radio channels than LTE, will be able to deliver much higher peak and average speeds, with initial estimates listed above in the section, “Data Throughput Comparison.” In the absence of deployed networks to measure, companies have performed simulations, concentrating initially on one of the first uses cases of fixed wireless access.

Figure 51 shows downlink performance for a network using different base station ISDs, and with and without foliage. The Nokia simulation used base stations with 512 antenna elements, outdoor-mounted user equipment, 28 GHz, and an 800-MHz radio channel, mostly allocated to the downlink.

Figure 51: Downlink Performance, Different ISDs, Foliage vs. None¹²⁷

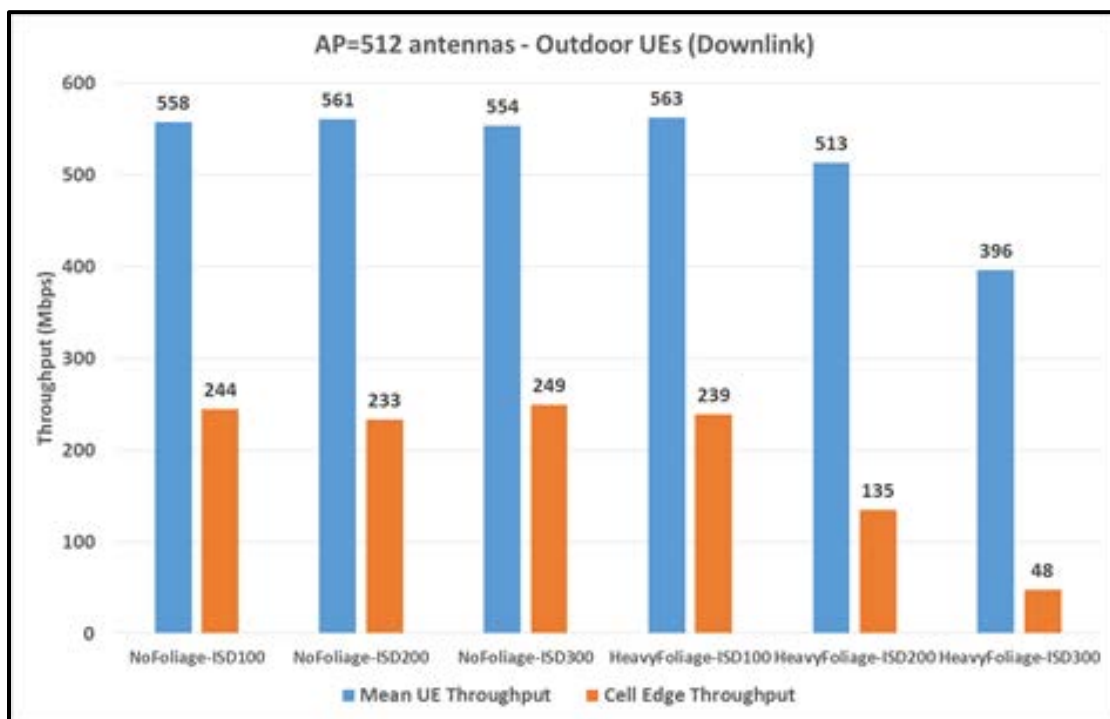

The conclusion of this simulation is that a minimum performance of 100 Mbps at the cell-edge, a 5G objective, is possible at ISDs up to 200 meters, with and without foliage.

The following three figures are from another simulation study by Ericsson, this one also for fixed-wireless access, with the following key assumptions: 350-meter ISD, 96-antenna base stations, 200 MHz radio channels, 57% allocated to downlink, 1000 homes per sq.

¹²⁷ Nokia contribution. For a full discussion, refer to the associated paper by Frederick W. Vook, Eugene Visotsky, Timothy A. Thomas, and Amitava Ghosh, Nokia Bell Labs, *Performance Characteristics of 5G mmWave Wireless-to-the-Home*, available at <http://ieeexplore.ieee.org/document/7869558/>.

km., 25% of homes using 4K UHD video service at 15 Mbps, building heights of 4 to 10 meters, and trees from 5 to 15 meters.

Figure 52 shows the throughputs available across the coverage area, with many locations able to receive close to 1 Gbps.

Figure 52: Throughput Map of Suburban Area at Low Load¹²⁸

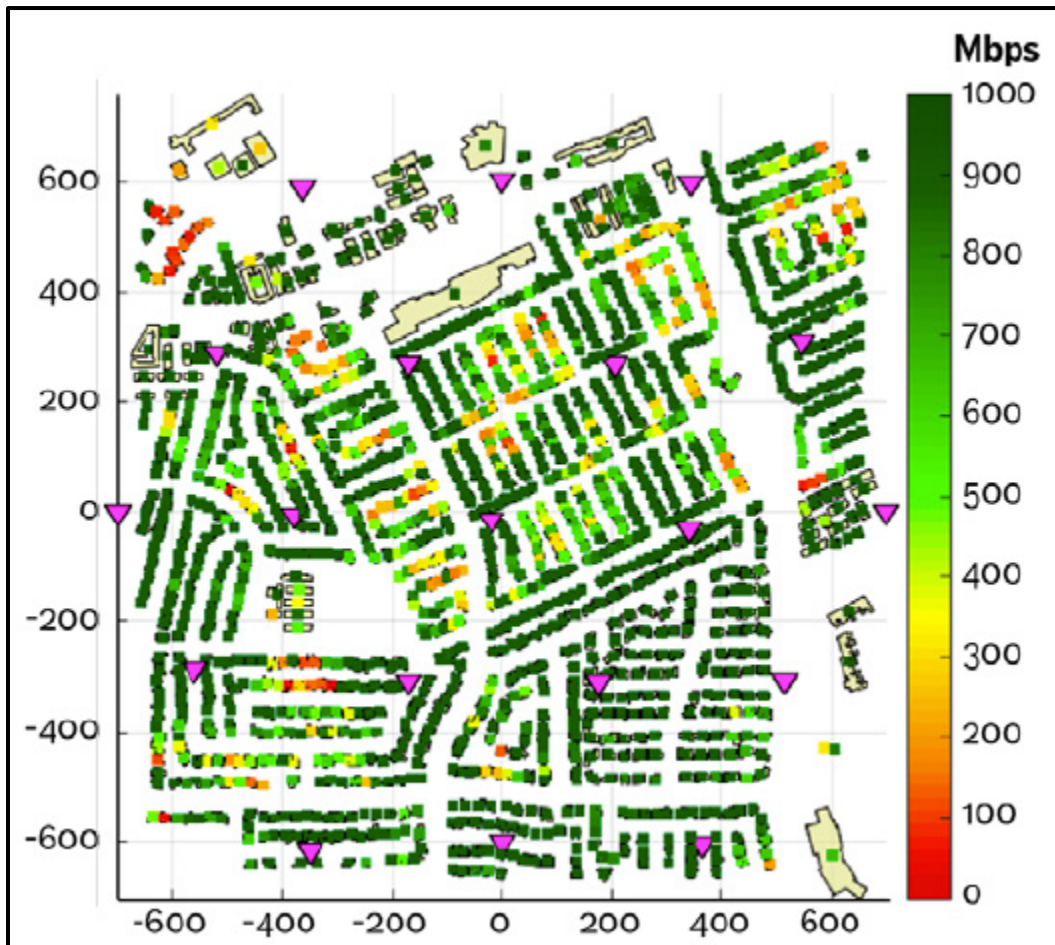

Figure 53 shows the proportion of users that can obtain 15 Mbps and 100 Mbps service relative to monthly traffic volume. Note that the system supports thousands of GBs of service per subscriber per month.

¹²⁸ Ericsson contribution, Ericsson Technical Review, *5G and Fixed Wireless Access*, 2016, available at <https://www.ericsson.com/assets/local/publications/ericsson-technology-review/docs/2016/etr-5g-and-fixed-wireless-access.pdf>.

Figure 53: Proportion of Satisfied Users Relative to Monthly Usage¹²⁹

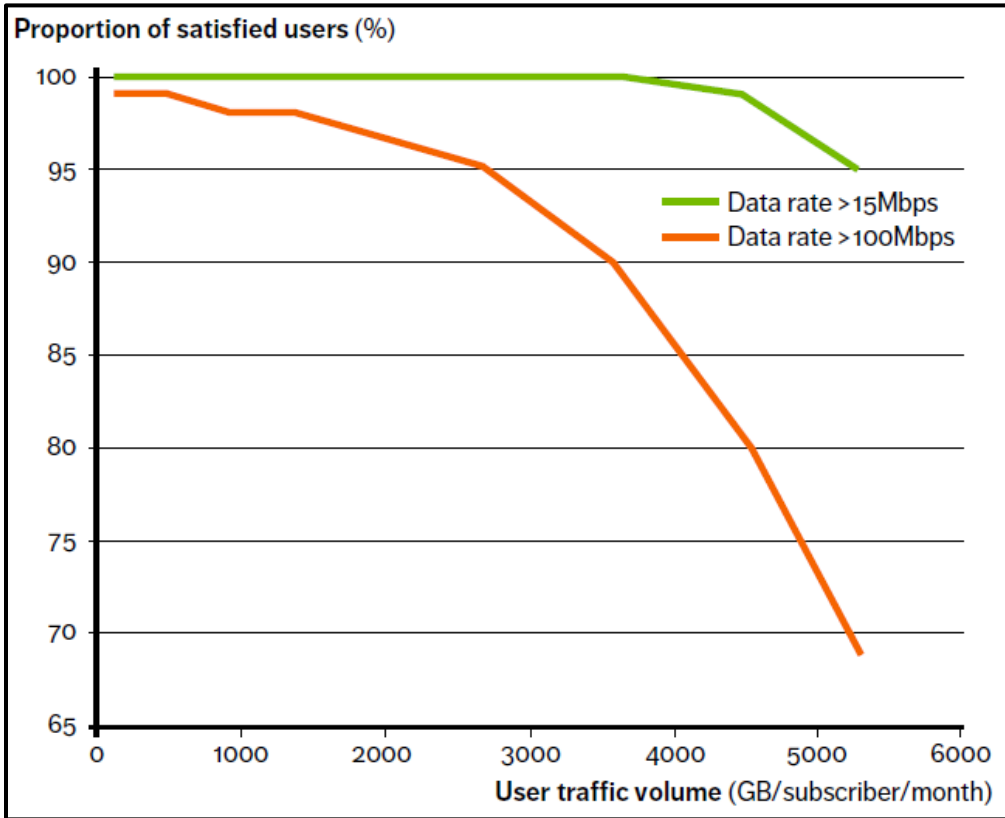
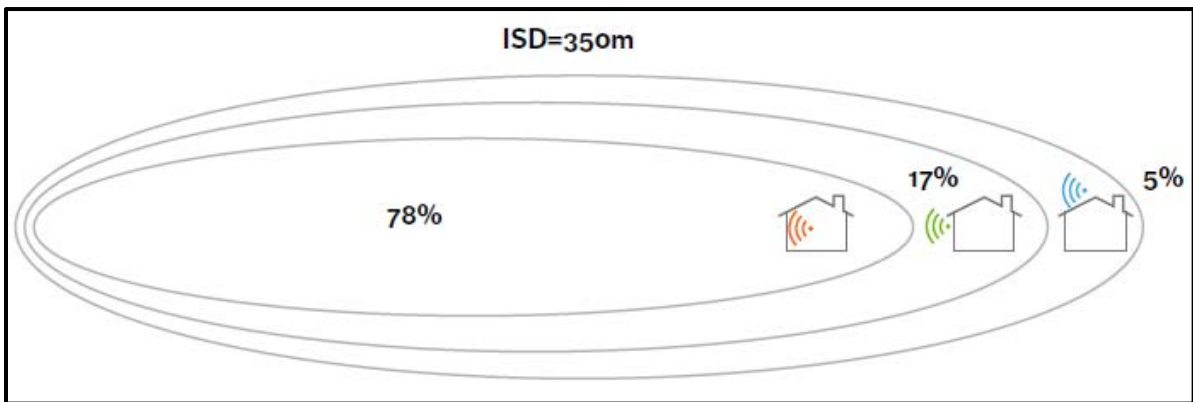

Figure 54 shows that an ISD of 350 can be used with a combination of indoor, wall-mounted, and rooftop antennas. A large percentage of users, 78%, can use indoor antennas, facilitating deployment.

Figure 54: Breakdown of Indoor, Wall-Mounted, and Rooftop Antennas¹³⁰



¹²⁹ Ibid.

¹³⁰ Ibid.

The simulation study shows that 5G fixed wireless access deployments using a larger ISD of 350 meters, translating to 11 base stations per square kilometer, can provide competitive broadband service.

In this environment, handsets with 5G mmWave capability will also be able to access the networks, but the antennas they use may not be as effective as the fixed-wireless equipment, so handsets may need to fall back to 4G, depending on their precise locations. For this reason, the dual-connectivity being planned for 5G will play an important role.

Figure 55 shows another simulation study, this one from Intel, using the following assumptions: 28 GHz operation, 2:1 DL:UL ratio, 25% control overhead, 10 bps/Hz maximum downlink spectral efficiency, CPEs placed either north or south side of house and one with best SNR chosen, and indoor CPE equipment with 30dB outdoor-to-indoor penetration loss. Scenario 1 is 60 access points per sq. km. Scenario 2 is 120 access points per sq. km. (Base grid of 40 houses in a 250x200m area with four rows of 10 houses per row, APs placed along streets and alleys, single-family homes, 4 sectors per AP, and 4.5-meter pole height.)

Figure 55: 5G Fixed Wireless Simulation with Different Loading and Densities¹³¹

DL	Scenario 1 (3 APs per 40 homes)				Scenario 2 (6 APs per 40 homes)			
	10% loading		50% loading		10% loading		50% loading	
	Cell-edge (Mbps)	Average (Mbps)	Cell-edge (Mbps)	Average (Mbps)	Cell-edge (Mbps)	Average (Mbps)	Cell-edge (Mbps)	Average (Mbps)
100 MHz, 64x8	5	200	4	160	50	290	45	230
100 MHz, 128x16	22	280	20	210	150	370	145	275
400 MHz, 128x16	88	1,120	80	840	600	1,480	580	1,100

UL	Scenario 1 (3 APs per 40 homes)				Scenario 2 (6 APs per 40 homes)			
	10% loading		50% loading		10% loading		50% loading	
	Cell-edge (Mbps)	Average (Mbps)	Cell-edge (Mbps)	Average (Mbps)	Cell-edge (Mbps)	Average (Mbps)	Cell-edge (Mbps)	Average (Mbps)
100MHz, 16x64	2	85	1	75	35	120	30	100
100MHz, 16x128	4	95	2	80	50	140	40	110
100MHz, 32x64	7	100	4	85	70	150	60	115

Using 400 MHz and six access points per 40 homes, and 50% loading, the average throughput was more than 1 Gbps.

LTE and LTE-Advanced

Although HSPA and HSPA+ offer a highly efficient broadband-wireless service that will enjoy success for the remainder of this decade and well into the next, 3GPP completed the specification for Long Term Evolution as part of Release 8. LTE offers even higher peak throughputs in wider spectrum bandwidth. Work on LTE began in 2004 with an official work item started in 2006 and a completed specification early 2009. Initial deployments began in 2010.

LTE uses OFDMA on the downlink, which is well suited to achieve high peak data rates in high-spectrum bandwidth. WCDMA radio technology is basically as efficient as OFDM for delivering peak data rates of about 10 Mbps in 5 MHz of bandwidth. Achieving peak rates

¹³¹ Intel contribution.

in the 100 Mbps range with wider radio channels, however, would result in highly complex terminals, and it is not practical with current technology, whereas OFDM provides a practical implementation advantage. Scheduling approaches in the frequency domain can also minimize interference, thereby boosting spectral efficiency. The OFDMA approach is also flexible in channelization: LTE operates in various radio channel sizes ranging from 1.4 to 20 MHz.

On the uplink, however, a pure OFDMA approach results in high Peak to Average Ratio (PAR) of the signal, which compromises power efficiency and, ultimately, battery life. Hence, LTE uses an approach called "SC-FDMA," which is somewhat similar to OFDMA, but has a 2 to 6 dB PAR advantage over the OFDMA method used by other technologies such as WiMAX.

LTE capabilities include:

- ❑ Downlink peak data rates up to 300 Mbps with 20+20 MHz bandwidth in initial versions, increasing to over 1 Gbps in subsequent versions through carrier aggregation, higher-order modulation, and 4X4 MIMO.
- ❑ Uplink peak data rates up to 71 Mbps with 20+20 MHz bandwidth in initial versions, increasing to over 1 Gbps in subsequent versions.
- ❑ Operation in both TDD and FDD modes.
- ❑ Scalable bandwidth up to 20+20 MHz covering 1.4, 3, 5, 10, 15, and 20 MHz radio carriers.
- ❑ Increased spectral efficiency over HSPA by a factor of two to four.
- ❑ Reduced latency, to 15 msec round-trip times between user equipment and the base station, and to less than 100 msec transition times from inactive to active.
- ❑ Self-organizing capabilities under operator control and preferences that will automate network planning and will result in lower operator costs.

LTE-Advanced Terminology

LTE-Advanced, as specified in Release 10, is a term used for the version of LTE that addresses IMT-Advanced requirements. The ITU ratified LTE-Advanced as IMT-Advanced in November 2010. LTE-Advanced is both backward- and forward-compatible with LTE, meaning LTE devices operate in newer LTE-Advanced networks, and LTE-Advanced devices operate in older, pre-Release 10 LTE networks.

The following lists at a high level the most important features of LTE-Advanced, as well as other features planned for subsequent releases, including Release 11:

- ❑ Carrier aggregation.
- ❑ Higher-order downlink MIMO (up to 8X8 in Release 10).
- ❑ Uplink MIMO (two transmit antennas in the device).
- ❑ Coordinated multipoint transmission (CoMP) in Release 11.
- ❑ Heterogeneous network (HetNet) support including Enhanced Inter-cell Interference Coordination (eICIC).
- ❑ Relays.

3GPP, from Release 13, has referred to LTE as LTE-Advanced Pro, which includes features such as LAA, LWA, low latency, and massive MIMO.

OFDMA and Scheduling

LTE implements OFDM in the downlink. The basic principle of OFDM is to split a high-rate data stream into a number of parallel, low-rate data streams, each a narrowband signal carried by a subcarrier. The different narrowband streams are generated in the frequency domain, and then combined to form the broadband stream using a mathematical algorithm called an “Inverse Fast Fourier Transform” (IFFT) that is implemented in digital signal processors. In LTE, the subcarriers have 15 kHz spacing from each other. LTE maintains this spacing regardless of the overall channel bandwidth, which simplifies radio design, especially in supporting radio channels of different widths. The number of subcarriers ranges from 72 in a 1.4 MHz radio channel to 1,200 in a 20 MHz radio channel.

The composite signal obtained after the IFFT is extended by repeating the initial part of the signal (called the Cyclic Prefix [CP]). This extended signal represents an OFDM symbol. The CP is basically a guard time during which reflected signals will reach the receiver. It results in an almost complete elimination of multipath-induced Intersymbol Interference (ISI), which otherwise makes extremely high data rate transmissions problematic. The system is called orthogonal because the subcarriers are generated in the frequency domain (making them inherently orthogonal), and the IFFT conserves that characteristic.

OFDM systems may lose their orthogonal nature as a result of the Doppler shift induced by the speed of the transmitter or the receiver. 3GPP specifically selected the subcarrier spacing of 15 kHz to avoid any performance degradation in high-speed conditions. WiMAX systems that use a lower subcarrier spacing (~11 kHz) are more impacted in high-speed conditions than LTE.

Figure 56: OFDM Symbol with Cyclic Prefix

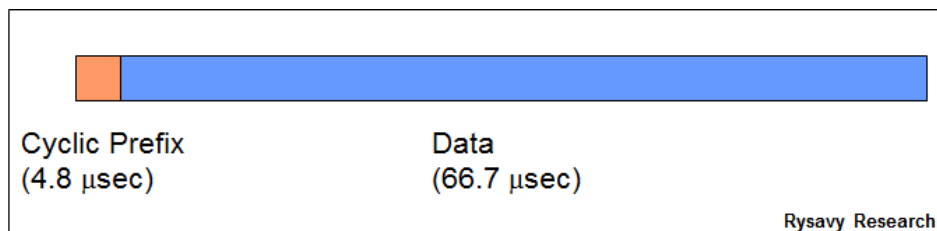

The multiple access aspect of OFDMA comes from being able to assign different users different subcarriers over time. A minimum resource block that the system can assign to a user transmission consists of 12 subcarriers over 14 symbols in 1.0 msec. Figure 57 shows how the system can assign these resource blocks to different users over both time and frequency.

Figure 57: LTE OFDMA Downlink Resource Assignment in Time and Frequency

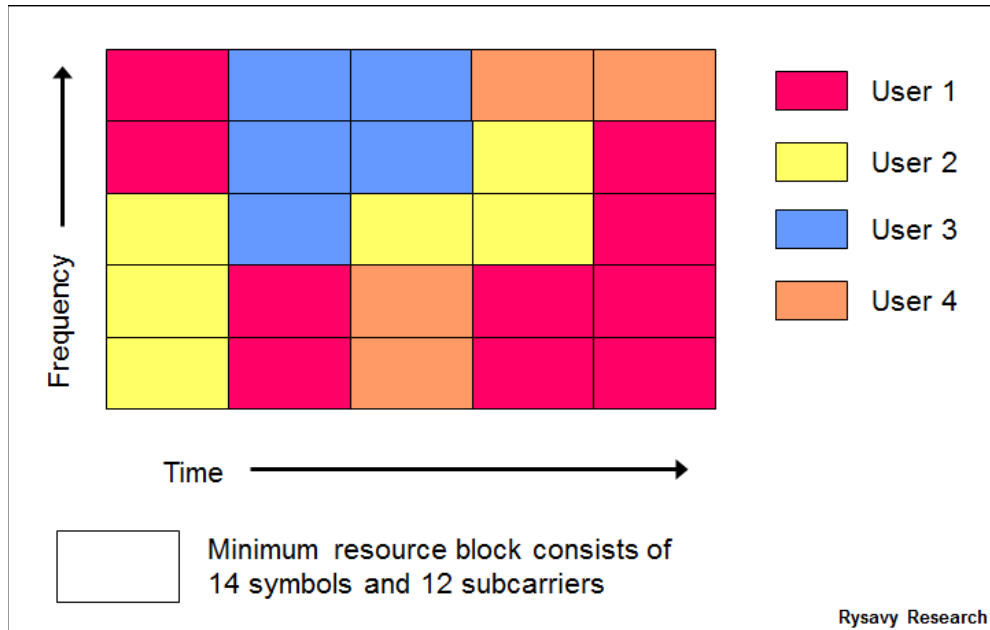

By controlling which subcarriers are assigned in which sectors, LTE can easily control frequency reuse. Using all the subcarriers in each sector, the system would operate at a frequency reuse of 1; but by using a different one third of the subcarriers in each sector, the system can achieve a looser frequency reuse of 1/3. The looser frequency reduces overall spectral efficiency but delivers high peak rates to users.

Beyond controlling frequency reuse, frequency domain scheduling, as shown in Figure 58 can use those resource blocks that are not faded, not possible in CDMA-based systems. Since different frequencies may fade differently for different users, the system can allocate those frequencies for each user that result in the greatest throughput. This results in up to a 40% gain in average cell throughput for low user speed (3 km/hour), assuming a large number of users and no MIMO. The benefit decreases at higher user speeds.

Figure 58: Frequency Domain Scheduling in LTE¹³²

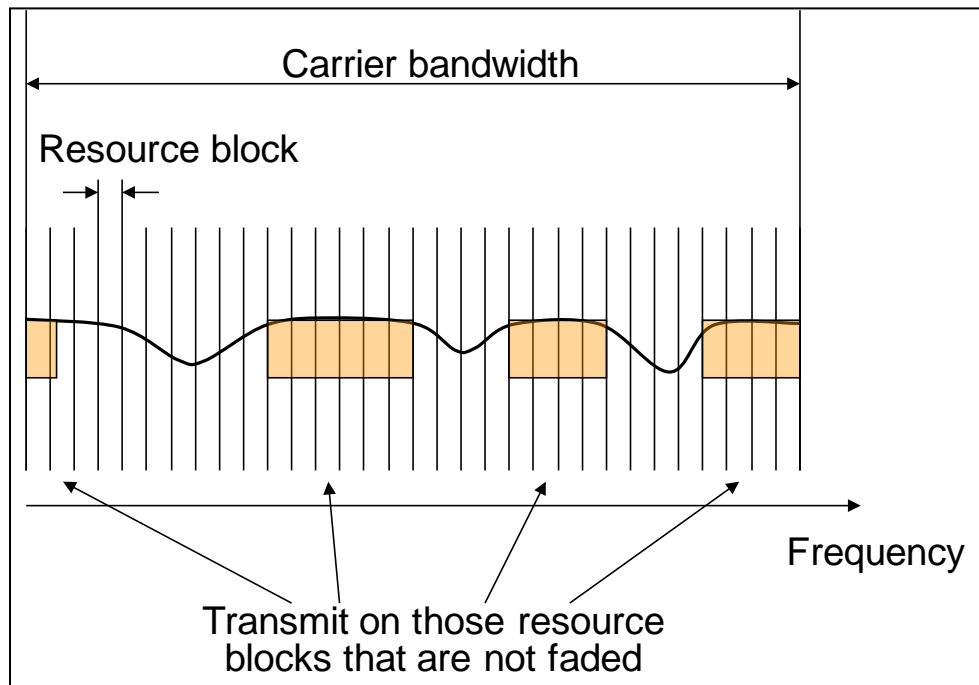

LTE Smart Antennas

Wireless networks can achieve significant gains by employing multiple antennas, either at the base station, the mobile device, or both. LTE uses multiple antennas in three fundamentally different ways:

- ❑ **Diversity.** So long as the antennas are spaced or polarized appropriately, the antennas provide protection against fading.
- ❑ **Beamforming.** Multiple antennas can shape a beam to increase the gain for a specific receiver. Beamforming can also suppress specific interfering signals. Beamforming is particularly helpful for improving cell-edge performance.
- ❑ **Spatial Multiplexing.** Often referred to as MIMO antenna processing, spatial multiplexing creates multiple transmission paths through the environment, effectively sending data in parallel through these paths, thus increasing both throughput and spectral efficiency.

Table 18 shows the various antenna transmission modes.

¹³² 5G Americas member contribution.

Table 18: LTE Transmission Modes¹³³

Transmission Mode	Description
1	Single antenna transmission.
2	Transmit Diversity.
3	Transmit diversity for one layer, open-loop codebook-based precoding if more than one layer.
4	Closed-loop codebook-based precoding.
5	Multi-user MIMO version of transmission mode 4.
6	Special case of closed-loop codebook-based precoding limited to single layer transmission.
7	Beamforming. (Non-codebook-based precoding supporting one layer.)
8	Dual-layer beamforming. (Release 9. Non-codebook-based precoding supporting up to two layers.)
9	8-layer transmission. (Release 10. Non-codebook-based precoding supporting up to eight layers.)
10	8-layer transmission with support for CoMP. (Release 11.)

Being able to exploit different antenna modes based on local conditions produces huge efficiency and performance gains, and is the reason that 3GPP is developing even more advanced antenna modes in subsequent LTE releases.

Precoding refers to a mathematical matrix operation performed on radio symbols to determine how they are combined and mapped onto antenna ports. The precoder matrix can operate in either open-loop or closed-loop modes. For each transmission rank for a given number of transmission ports (antennas), there is a limited set of precoder matrices defined, called the codebook. This helps limit the amount of signaling needed on uplink and downlink.

Fundamental variables distinguish the different antenna modes:

- **Single base station antenna versus multiple antennas.** Single antennas provide for Single Input Single Output (SISO), SIMO, and planar-array beamforming. (Multiple Output means the UE has multiple antennas.) Multiple antennas at the base station provide for different MIMO modes such as 2X2, 4X2, and 4X4.

¹³³ Erik Dahlman, Stefan Parkvall, Johan Skold, *4G - LTE/LTE Advanced for Mobile Broadband*, Academic Press, 2011.

- ❑ **Single-user MIMO versus multi-user MIMO.** Release 8 only provides for single-user MIMO on the downlink. Release 10 includes multi-user MIMO.
- ❑ **Open-Loop versus Closed-Loop.** High vehicular speeds require open-loop operation whereas slow speeds enabled closed-loop operation in which feedback from the UE modifies the transmission. In closed-loop operation, the precoder matrix is based on this feedback.
- ❑ **Rank.** In a MIMO system, the channel rank is formally defined as the rank of the channel matrix and is a measure of the degree of scattering that the channel exhibits. For example, in a 2x2 MIMO system, a rank of one indicates a low-scattering environment, while a rank of two indicates a high-scattering environment. The rank two channel is highly uncorrelated, and is thus able to support the spatial multiplexing of two data streams, while a rank one channel is highly correlated, and thus can only support single stream transmission (the resulting multi-stream interference in a rank one channel as seen at the receiver would lead to degraded performance). Higher Signal to Interference plus Noise Ratios (SINR) are typically required to support spatial multiplexing, while lower SINRs are typically sufficient for single stream transmission. In a 4x4 MIMO system channel rank values of three and four are possible in addition to values of one and two. The number of data streams, however, or more specifically codewords in LTE is limited to a value of two. Thus, LTE has defined the concept of layers, in which the DL transmitter includes a codeword-to-layer mapping, and in which the number of layers is equal to the channel rank. An antenna mapping or precoding operation follows, which maps the layers to the antenna ports. A 4x2 MIMO system is also possible with LTE Release 8, but here the channel rank is limited to the number of UE antennas, which is equal to two.

The network can dynamically choose between different modes based on instantaneous radio conditions between the base station and the UE. Figure 59 shows the decision tree. The antenna configuration (AC) values refer to the transmission modes. Not every network will support every mode. Operators will choose which modes are the most effective and economical. AC2, 3, 4, and 6 are typical modes that will be implemented.

Figure 59: Decision Tree for Different Antenna Schemes¹³⁴

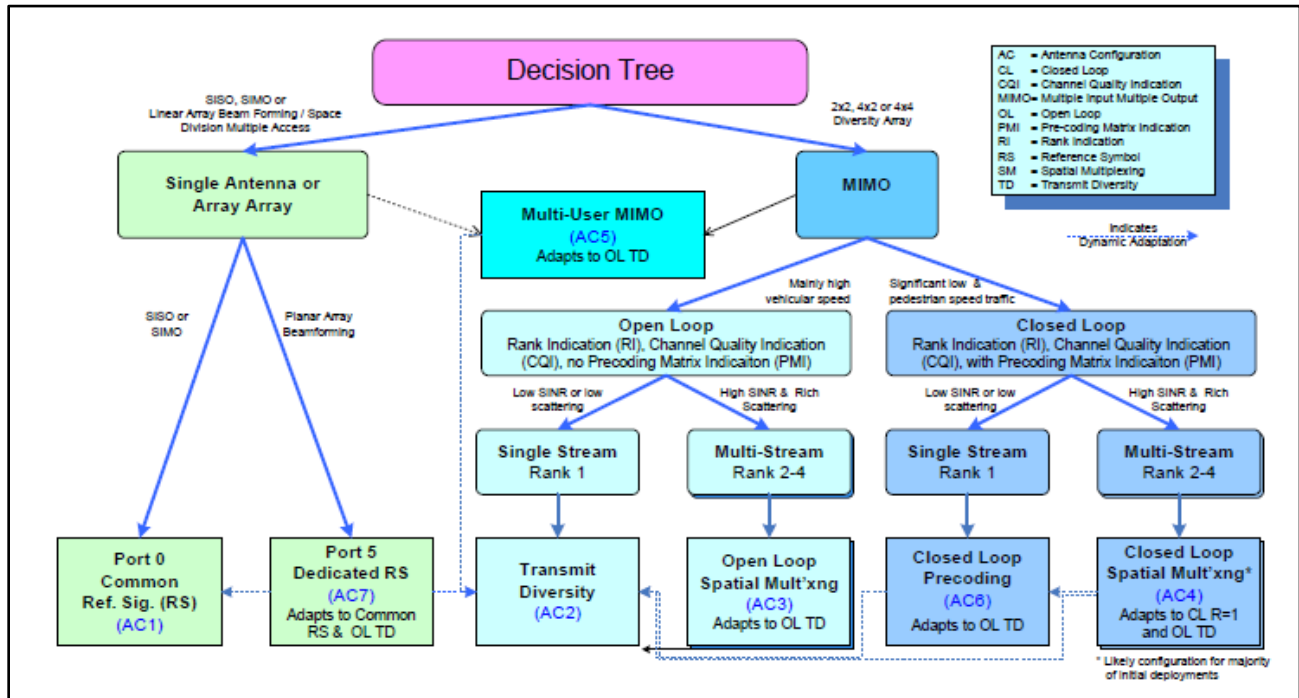

The simplest mode is AC2, referred to as Transmit Diversity (TD) or sometimes Space Frequency Block Code (SFBC) or even Open Loop Transmit Diversity. TD can operate under all conditions, meaning it works under low SINR, high mobility, and low channel rank (rank = 1). This rank means that the channel is not sufficiently scattered or de-correlated to support two spatial streams. Thus, in TD, only one spatial stream or what is sometimes referred as a single codeword (SCW) is transmitted. If the channel rank increases to a value of two, indicating a more scattered channel, and the SINR is a bit higher, then the system can adapt to AC3 or Open-Loop Spatial Multiplexing (OL-SM), also referred to as large-delay Cyclic Delay Diversity (CDD). This mode supports two spatial streams or two codewords. This mode, also called multiple codeword (MCW) operation, increases throughput over SCW transmission.

If the rank of the channel is one, but the device is not moving very fast or is stationary, then the system can adapt to AC6, called closed-loop (CL) precoding (or CL-rank 1 or CL-R1). In this mode, the network receives from the device with Precoding Matrix Indication (PMI) bits that inform the base station what precoding matrix to use in the transmitter to optimize link performance. This feedback is only relevant for low-mobility or stationary conditions since in high mobility conditions the feedback will most likely be outdated by the time the base station can use it.

Another mode is AC4 or Closed Loop Spatial Multiplexing (CL-SM), which is enabled for low-mobility, high SINR, and channel rank of two. This mode theoretically provides the best user throughput. The figure above shows how these modes can adapt downwards to either OL TD, or if in CL-SM mode, down to either OL TD or CL R1.

¹³⁴ 4G Americas *MIMO and Smart Antennas for 3G and 4G Wireless Systems – Practical Aspects and Deployment Considerations*, May 2010.

For a 4x4 MIMO configuration, the channel rank can take on values of three and four in addition to one or two. Initial deployment at the base station, however, will likely be two TX antennas and most devices will only have 2 RX antennas, and thus the rank is limited to 2.

AC5 is MU-MIMO, which is not defined for the downlink in Release 8.

AC1 and AC7 are single antenna port modes in which AC1 uses a common Reference Signal (RS), while AC7 uses a dedicated RS or what is also called a user specific RS. AC1 implies a single TX antenna at the base station. AC7 implies an antenna array with antennal elements closely spaced so that a physical or spatial beam can be formed toward an intended user.

LTE operates in a variety of MIMO configurations. On the downlink, these include 2X2, 4X2 (four antennas at the base station), and 4X4. Initial deployment will likely be 2x2 whereas 4X4 will be most likely used initially in femtocells. On the uplink, there are two possible approaches: single-user MIMO (SU-MIMO) and multi-user MIMO (MU-MIMO). SU-MIMO is more complex to implement as it requires two parallel radio transmit chains in the mobile device, whereas MU-MIMO does not require any additional implementation at the device but relies on simultaneous transmission on the same tones from multiple mobile devices.

The first LTE Release thus incorporates MU-MIMO with SU-MIMO deferred for subsequent LTE releases. An alternate form of MIMO, originally called network MIMO, and now called CoMP, relies on MIMO implemented (on either the downlink or uplink or both) using antennas across multiple base stations, as opposed to multiple antennas at the same base station. This paper explains CoMP in the section on LTE Advanced below.

Peak data rates are approximately proportional to the number of send and receive antennas. 4X4 MIMO is thus theoretically capable of twice the data rate of a 2X2 MIMO system. The spatial multiplexing MIMO modes that support the highest throughput rates will be available in early deployments.

For a more detailed discussion of 3GPP antenna technologies, refer to the 5G Americas white paper "MIMO and Smart Antennas for 3G and 4G Wireless Systems – Practical Aspects and Deployment Considerations," May 2010.

For advancements in LTE Smart Antennas, see the next section.

LTE-Advanced Antenna Technologies

Release 10 added significant enhancements to antenna capabilities, including four-layer transmission resulting in peak spectral efficiency exceeding 15 bps/Hz. Uplink techniques fall into two categories: those relying on channel reciprocity and those that do not. With channel reciprocity, the eNB determines the channel state by processing a Sounding Reference Signal from the UE. It then forms transmission beams accordingly. The assumption is that the channel received by the eNB is the same as the UE. Techniques that use channel reciprocity are beamforming, SU-MIMO, and MU-MIMO. Channel reciprocity works especially well with TDD since both forward and reverse links use the same frequency.

Non-reciprocity approaches apply when the transmitter has no knowledge of the channel state. Techniques in this instance include open-loop MIMO, closed-loop MIMO, and MU-MIMO. These techniques are more applicable for higher speed mobile communications.

For the downlink, the technology can transmit in as many as eight layers using an 8X8 configuration for a peak spectral efficiency of 30 bps/Hz. This exceeds the IMT-Advanced requirements, conceivably supporting a peak rate of 1 Gbps in just 40+40 MHz, and even higher rates in wider bandwidths. This would require additional reference signals for channel estimation and for measurements, including channel quality, to enable adaptive, multi-antenna transmission.

Release 10 supports a maximum of two codewords, the same as previous LTE releases. The release specifies a new transmission mode (TM-9) that supports SU-MIMO up to Rank 8 (up to eight layers), as well as the ability to dynamically switch between SU-MIMO and MU-MIMO.

Figure 60 shows the different forms of single-user MIMO in Releases 8, 9, and 10. Release 8 supports only a single layer, whereas two-layer beamforming is possible in Release 9, and eight layers are possible in Release 10 with eight antennas at the base station.

Figure 60: Single-User MIMO¹³⁵

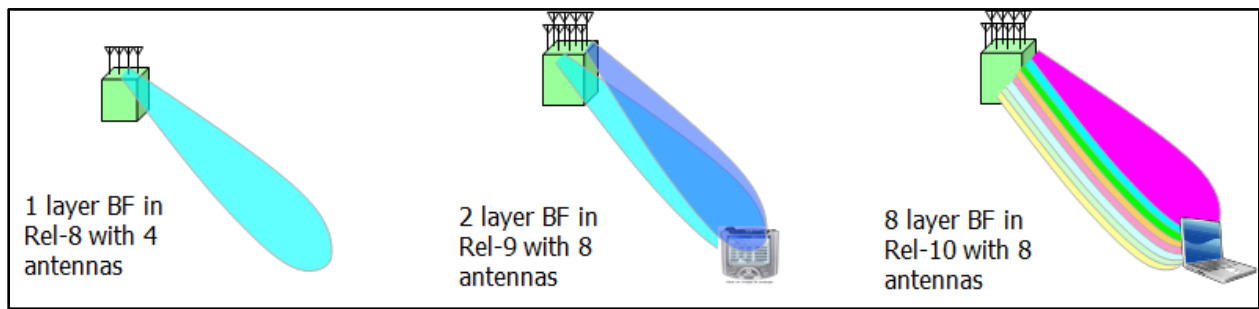
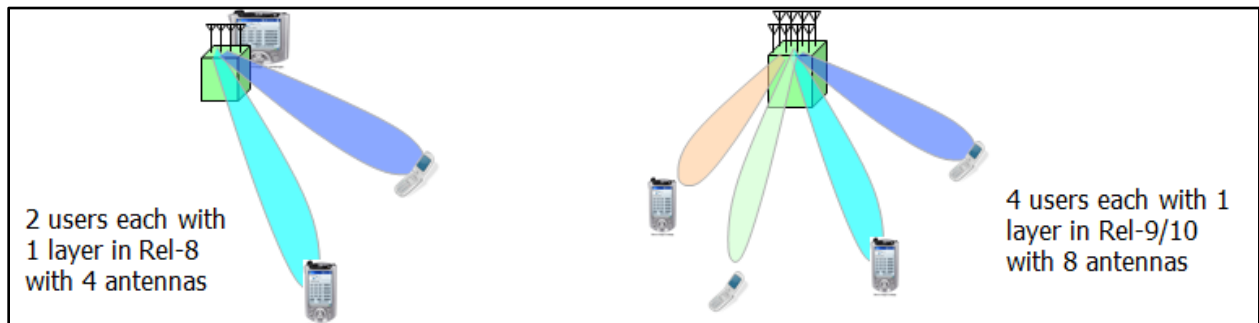

Figure 61 shows multi-user MIMO options across different releases. Release 8 supports two simultaneous users, each with one layer using four antennas, while Releases 9 and 10 support four simultaneous users, each with one layer.

Figure 61: Multi-User MIMO¹³⁶



For four-antenna configurations at the base station, Release 12 improves throughput by adding a feedback mode, called mode 3-2, in which sub-band precoders and sub-band

¹³⁵ 5G Americas member contribution.

¹³⁶ 5G Americas member contribution.

channel quality indicators (CQIs) are included in the UE's feedback to the eNodeB. Release 12 also adds a new codebook that further improves throughput.

As depicted in Figure 62 and Figure 63, compared with the Release 8 codebook, the new Release 12 codebook provides a 10% gain for both median and cell-edge throughputs. Compared with feedback mode 3-1, feedback mode 3-2 provides an 18% to 20% gain in median and cell-edge throughput. Jointly, the two methods provide a 28% to 30% gain.

Figure 62: Median Throughput of Feedback Mode 3-2 and New Codebook.¹³⁷

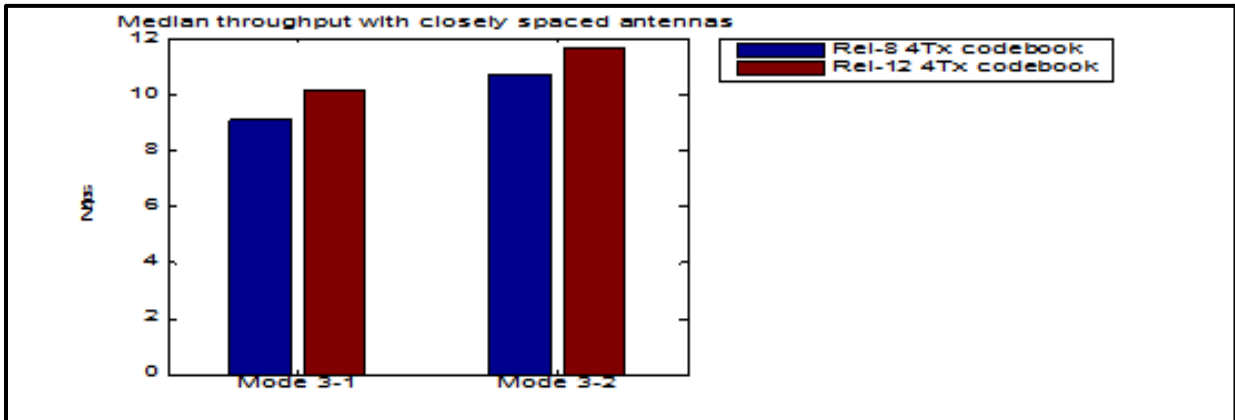
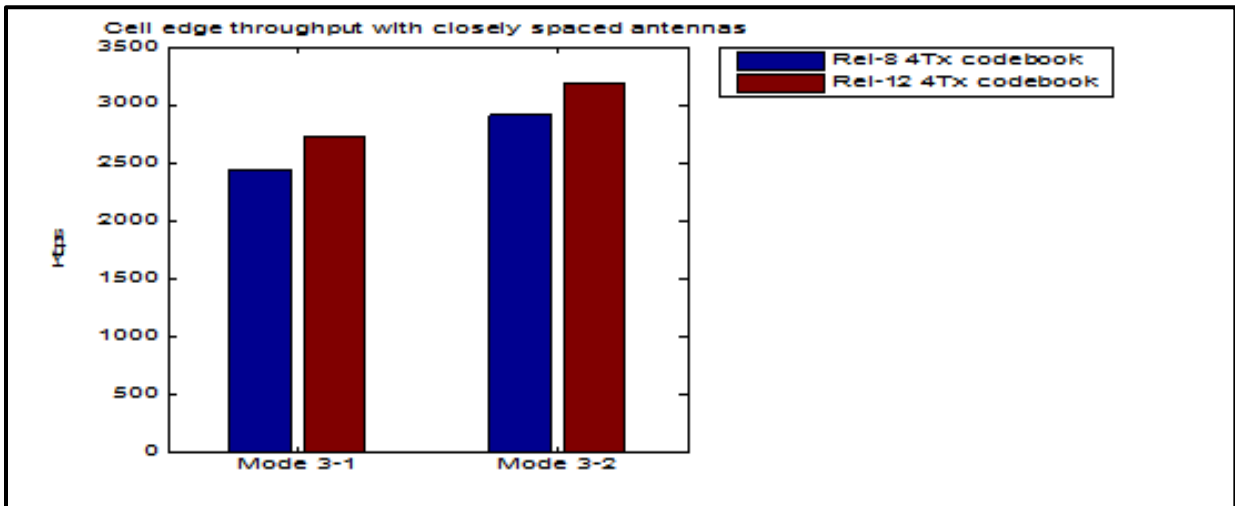

Figure 63: Cell-Edge Throughput of Feedback Mode 3-2 and New Codebook¹³⁸



Release 12 also defines how Active Antenna Systems can use multiple transceivers on an antenna array to dynamically adjust a radiation pattern.

¹³⁷ 5G Americas member contribution. Assumptions include: cellular layout of 19 sites hexagonal grid with three sectors per site and 500-meter inter-site distance; simulation case ITU uMa for macro; carrier frequency 2 GHz, deployment scenario A homogenous macro; SU-MIMO with maximum two layers per UE; proportional fair scheduler; and bursty traffic model.

¹³⁸ 5G Americas member contribution. Same assumptions as previous figure.

Release 13 is likely to define full-dimension MIMO, which adds a large number of antenna elements, potentially as many as 64 elements.

A practical consideration with antennas is that many towers today already support multiple operators, with tower companies having to manage interference placement, spectrum allocations, and wind and snow load. At higher frequencies, a single radome (antenna enclosure) can support 4X2 MIMO, but higher-order MIMO may prove impractical for many deployments.

5G systems operating at much higher frequencies will have an advantage since the antenna arrays will be much smaller due to the much smaller wavelengths.

Initial massive MIMO techniques applied to LTE, such as full-dimension MIMO using 8, 16, and 64 transmit antennas, can provide dramatic performance gains, particularly in dense deployments, as shown in Figure 64.

Figure 64: Performance Gains with FD-MIMO Using 200 Meter ISD¹³⁹

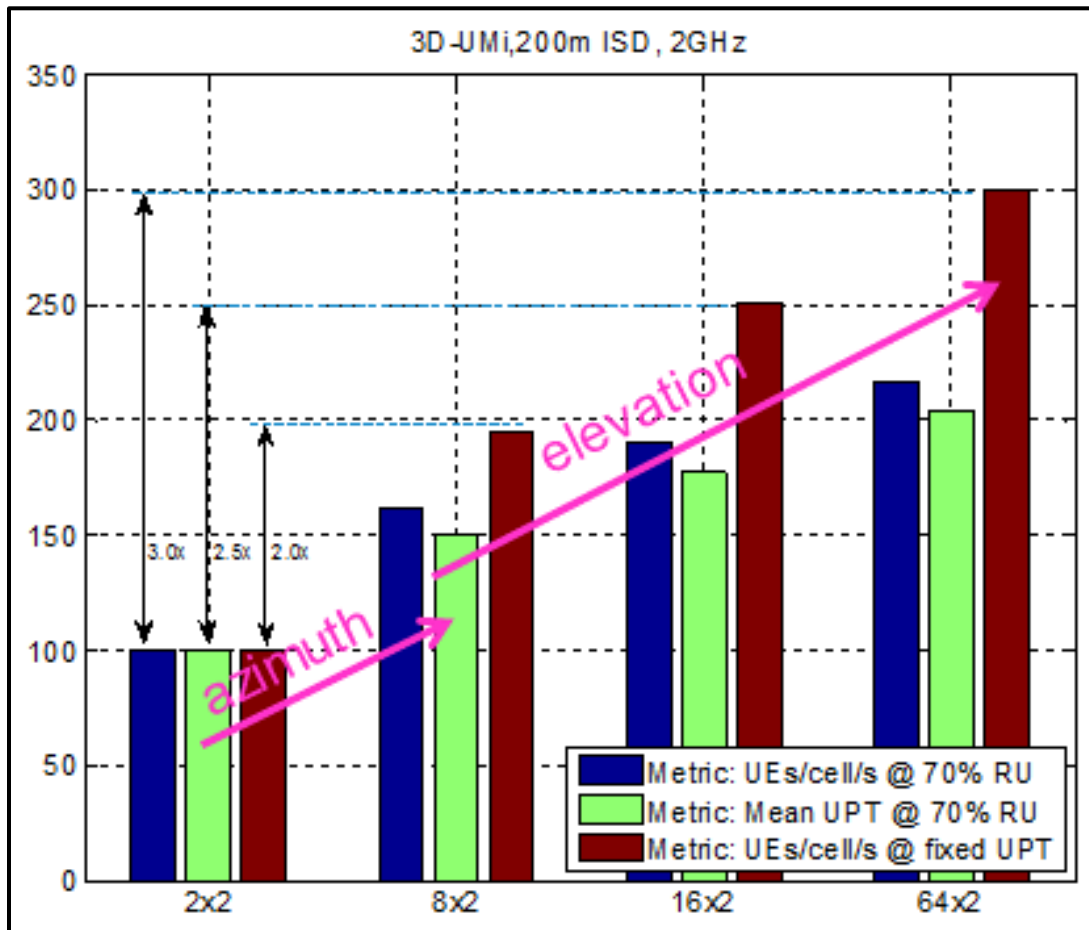

This figure compares 8X2, 16X2, and 64X2 MIMO performance relative to 2X2 MIMO (normalized to value 100). The blue bars (case 1) show the supported number of users per sector (referred to as “cell” in the figure) at a fixed resource utilization (RU) of 70%; the

¹³⁹ 5G Americas member contribution.

green bars (case 2) show mean user throughput (UPT) at a fixed RU of 70%; and the red bars (case 3) show system capacity in terms of supported number of users for a given user throughput. Resulting gains are:

- ❑ Case 2 (green bars): 1.5X with 8X2, 1.75X with 16X2, and 2X with 64X2 MIMO.
- ❑ Case 3 (red bars): 2X with 8X2, 2.5X with 16X2, and 3X with 64X2 MIMO.

The primary gains are from azimuth (horizontal dimension) in going from 2X2 to 8X2, and from elevation in going to 16X2 and 64X2. FD-MIMO gains are lower with larger ISD values, such as 500 meters.

3GPP has also studied FD-MIMO and conducted a field trial showing impressive throughput gains, particularly in a high-rise scenario.¹⁴⁰

Carrier Aggregation

Carrier aggregation, first available in Release 10, plays an important role in providing operators maximum flexibility for using all of their available spectrum. By combining spectrum blocks, LTE can deliver much higher throughputs than otherwise possible. Asymmetric aggregation (for example, different amounts of spectrum used on the downlink versus the uplink) provides further flexibility and addresses the greater demand on downlink traffic.

Specific types of aggregation include:

- ❑ Intra-band on adjacent channels.
- ❑ Intra-band on non-adjacent channels.
- ❑ Inter-band (700 MHz, 1.9 GHz).
- ❑ Inter-technology (for example, LTE on one channel, HSPA+ on another). This approach is not currently specified nor being developed. While theoretically promising, a considerable number of technical issues would have to be addressed.¹⁴¹ See Figure 65.

¹⁴⁰ 3GPP, *3D-MIMO Prototyping and Initial Field Trial Results*, TSG RAN WG1 Meeting #80, Agenda Item: 7.2.4.4, Document R1-150451.

¹⁴¹ For further details, see 4G Americas, *HSPA+ LTE Carrier Aggregation*, June 2012.

Figure 65: Inter-Technology Carrier Aggregation¹⁴²

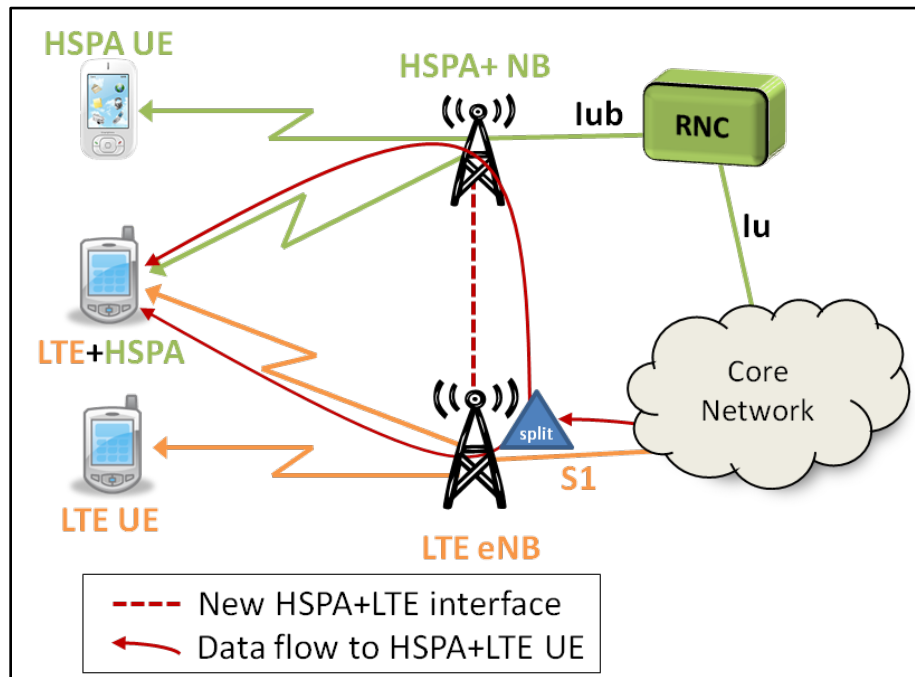
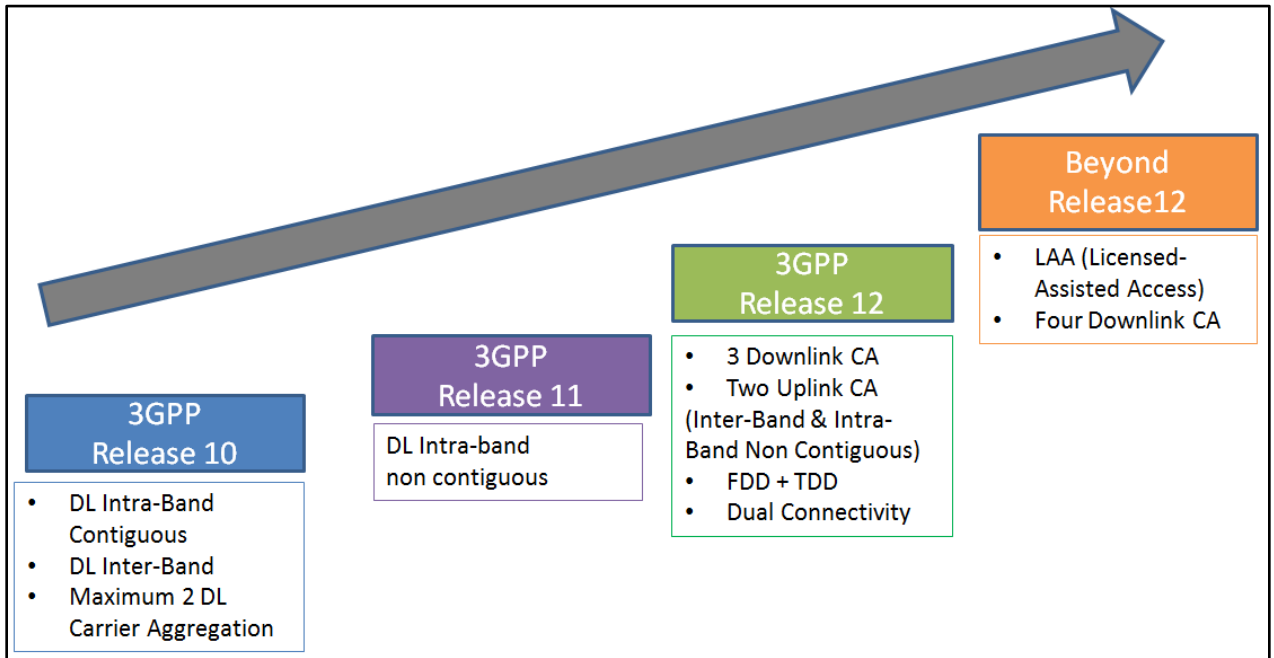

Figure 66 depicts the carrier-aggregation capabilities of different 3GPP releases.

¹⁴² 5G Americas member contribution.

Figure 66: Carrier Aggregation Capabilities across 3GPP Releases¹⁴³



One anticipated benefit of inter-band aggregation stems from using the lower-frequency band for users who are at the cell edge, to boost their throughput rates. Though this approach improves average aggregate throughput of the cell by only a small amount (say, 10%), it results in a more uniform user experience across the cell coverage area.

Figure 67 shows an example of intra-band carrier aggregation using adjacent channels with up to 100+100 MHz of bandwidth supported. Radio-access network specifications, however, limit the number of carriers to two in Release 10 and Release 11.

Figure 67: Release 10 LTE-Advanced Carrier Aggregation¹⁴⁴

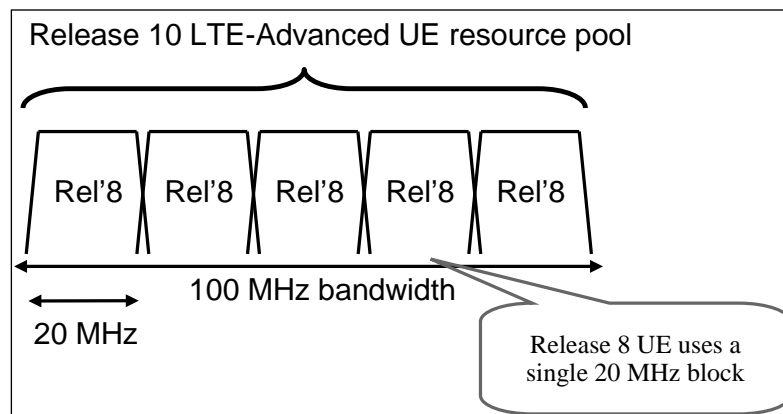

¹⁴³ 4G Americas, *Mobile Broadband Evolution: Rel-12 & Rel-13 and Beyond*, 2015.

¹⁴⁴ Harri Holma and Antti Toskala, *LTE for UMTS, OFDMA and SC-FDMA Based Radio Access*, Wiley, 2009.

Figure 68 shows the carrier aggregation operating at different protocol layers.

Figure 68: Carrier Aggregation at Different Protocol Layers¹⁴⁵

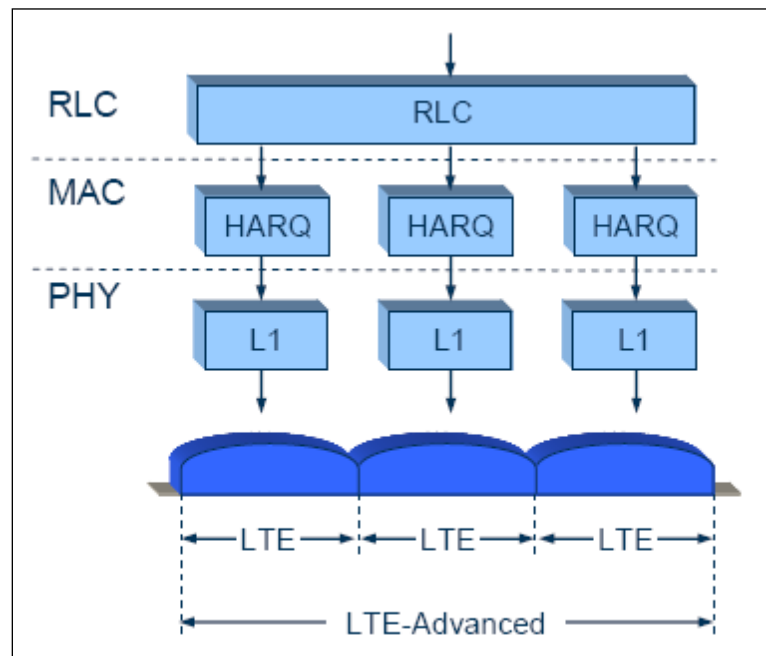

For a list of band combinations, refer to the 5G Americas white paper, *Wireless Technology Evolution Towards 5G: 3GPP Release 13 to Release 15 and Beyond*, February 2017, at section 3.4.3.

Figure 69 shows the result of one simulation study that compares download throughput rates between the blue line, which shows five user devices in 700 MHz and five user devices in AWS not using CA, and the pink line, which shows ten user devices that have access to both bands. Assuming a lightly loaded network with CA, 50% or more users (the median) experience 91% greater throughput, and 95% or more users experience 50% greater throughput. These trunking gains are less pronounced in heavily loaded networks.

¹⁴⁵ Stefan Parkvall and David Astely, Ericsson Research, "The Evolution of LTE towards IMT-Advanced," *Journal of Communications*, Vol. 4, No. 3, April 2009. Available at <http://www.academypublisher.com/jcm/vol04/no03/jcm0403146154.pdf>.

Figure 69: Gains from Carrier Aggregation¹⁴⁶

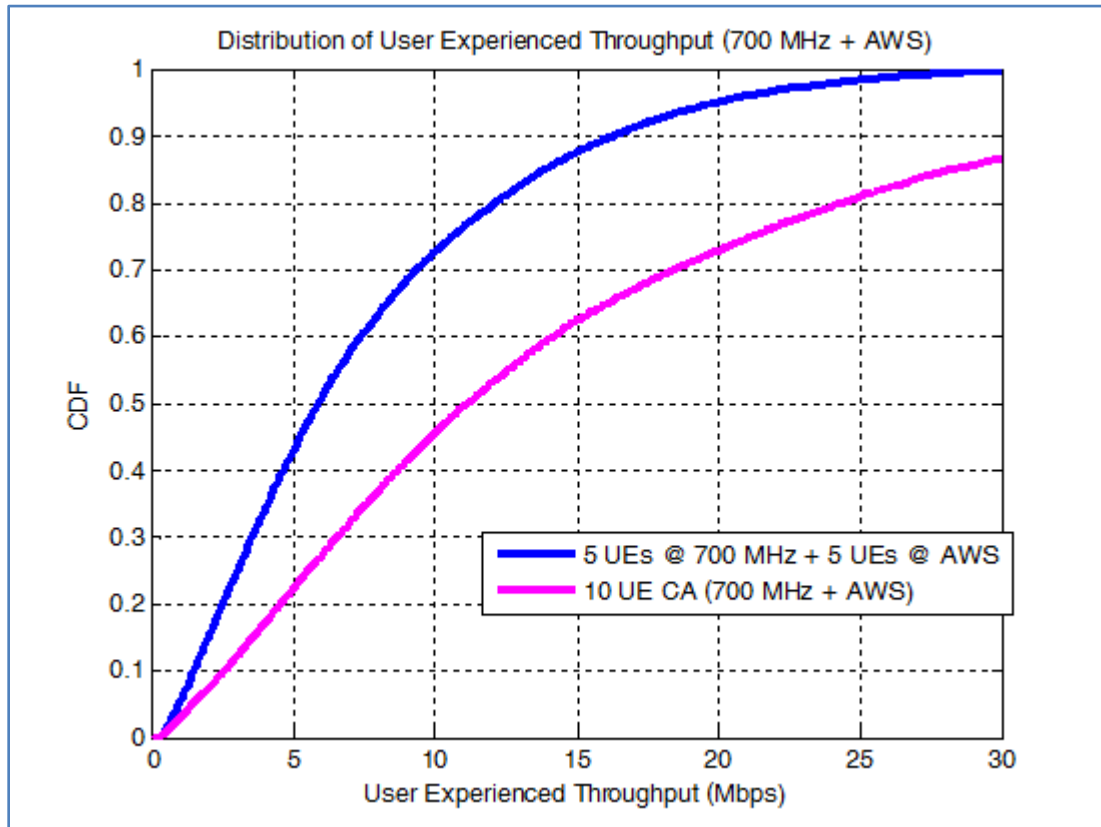

Work in Release 12 is investigating aggregation of joint TDD and FDD carriers.

Coordinated Multi Point (CoMP)

Coordinated Multi Point (CoMP) is a communications technique that can improve coverage, cell-edge throughput, and/or system spectrum efficiency by reducing interference. This technique was thoroughly studied during the development of LTE-Advanced Release 10 and was standardized in Release 11.

CoMP coordinates transmissions at different cell sites, thereby achieving higher system capacity and improving cell-edge data rates.

The main principle of CoMP is that a UE at a cell edge location can receive signals from multiple transmission points, and/or its transmitted signal can be received by multiple reception points. Consequently, if these multiple transmission points coordinate their transmissions, the DL throughput performance and coverage can improve.

For the UL, signals from the UE received at multiple reception points can significantly improve the link performance. Techniques can range from simple interference avoidance methods, such as Coordinated Beam Switching (CBS) and Coordinated Beam Forming

¹⁴⁶ 5G Americas member contribution. Assumptions: lightly-loaded network, 2.0 site-to-site distance, file size is 750 Kbytes, traffic model bursty with mean inter-arrival time of five seconds.

(CBF), to complex joint processing techniques that include Joint Transmission (JT), Joint Reception (JR), and Dynamic Point Selection (DPS).

CoMP architectures include inter-site CoMP, intra-site CoMP, as well as CoMP with distributed eNBs (i.e., an eNB with distributed remote radio heads). Figure 70 shows two possible levels of coordination.

Figure 70: Different Coordination Levels for CoMP¹⁴⁷

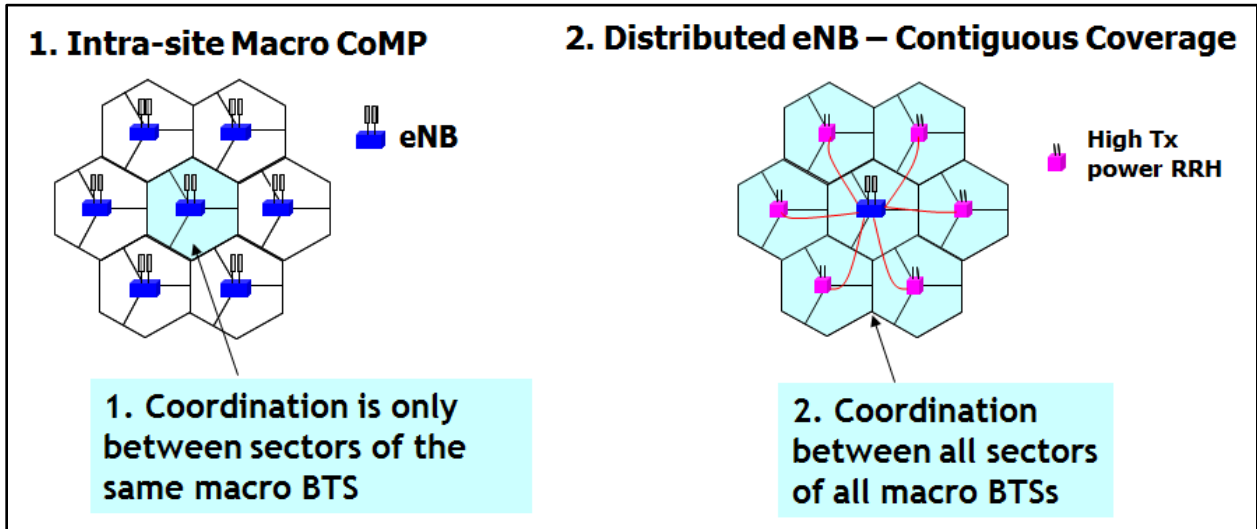

In one CoMP approach, called coordinated scheduling and shown in Figure 71, a single site transmits to the user, but with scheduling, including any associated beamforming, coordinated between the cells to reduce interference between the different cells and to increase the served user’s signal strength. In Joint Transmission, another CoMP approach also shown in Figure 71, multiple sites transmit simultaneously to a single-user. This approach can achieve higher performance than coordinated scheduling, but it has more stringent backhaul communications requirements. One simpler form of CoMP that will be available in Release 10, and then further developed in Release 11, is ICIC. Release 11 of LTE defines a common feedback and signaling framework for enhanced CoMP operation.

Figure 71: Coordinated Scheduling/BF and Joint Processing CoMP Approaches¹⁴⁸

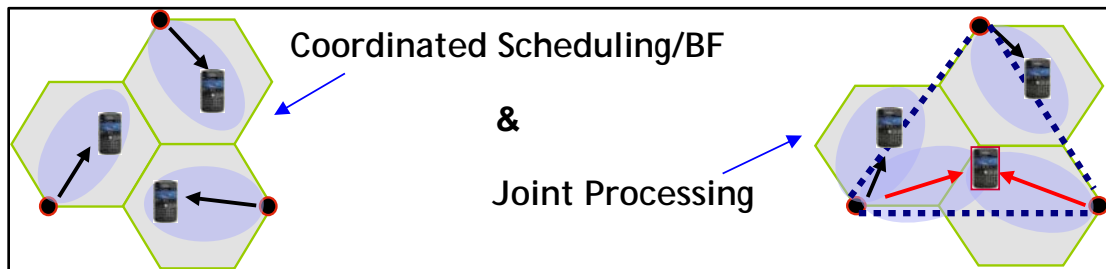

¹⁴⁷ 5G Americas member contribution.

¹⁴⁸ 5G Americas member contribution.

Release 11 also implements CoMP on the uplink, by which multiple base stations receive uplink transmissions and jointly process the signal, resulting in significant interference cancellation and improvements to spectral efficiency.

The performance gains expected from CoMP are under discussion in the industry. According to 3GPP document TR 36.819, for the case of resource utilization below 35%, CoMP may provide a 5.8% performance gain on the downlink for the mean user and a 17% gain for cell-edge users relative to HetNets without eICIC. For resource utilization of more than 35%, CoMP may provide a 17% mean gain and a 40% cell-edge gain.¹⁴⁹ CoMP can also be used in combination with eICIC for additional gains.

In the same 3GPP TR 36.819 document, 3GPP estimates the downlink CoMP gain in spectral efficiency, defined as average sector throughput for full buffer traffic using JT and 4x2 MU-MIMO as defined in R11, compared with 4x2 MU-MIMO based on R10, to be about 3% for intra-eNodeB CoMP. That gain drops to about 9% for inter-eNodeB CoMP in the case of no delay in the backhaul used to exchange information between eNodeBs. The corresponding gains in cell-edge user throughput are 20% and 31%, respectively.

When increasing the backhaul latency to a more realistic value of 10 msec for inter-eNodeB, spectral efficiency decreases to zero, and the cell edge gain decreases to 10%.

The gains for DL CoMP based on Coordinated Scheduling/Coordinated Beamforming (CS/CB) and intra-eNodeB are less than that provided by JT, with spectral efficiency at 1% and cell edge gains at 4%.

All of the above gains are for FDD networks with cross-polarized antennas at the eNodeBs. For TDD networks, the gains are higher by virtue of being able to invoke channel reciprocity and thus infer the DL channel directly from the UL channel. For example, for intra-eNodeB CoMP with JT 4x2 MU-MIMO, the respective gains in spectral efficiency and cell-edge throughput are 14% and 29%, respectively.

The gains for UL CoMP based on Joint Reception (JR) are greater than the DL gains. For intra-eNodeB CoMP, the average and cell-edge throughputs are increased to 22% and 40%, assuming two receive antenna paths with SU-MIMO. These respective gains increase to 31% and 66% for inter-eNodeB CoMP. In addition, UL CoMP does not require standardization and thus facilitates vendor implementation.

Uplink CoMP assists VoLTE because it improves cell-edge performance, making voice handover more reliable when traversing between cells. The benefit is analogous to CDMA soft handover; in both cases, the mobile device communicates with two sites simultaneously.

Cellular V2X Communications

In Release 14, 3GPP is specifying cellular vehicle-to-X (C-V2X) communications with two complementary transmission modes: direct communications between vehicles and network communications.

Direct communications will use bands such as the Intelligent Transportation Systems (ITS) 5.9 GHz band, using the PC5 interface specified for LTE device-to-device communications,

¹⁴⁹ 3GPP, *Coordinated Multi-Point Operation for LTE Physical Layer Aspects, TR 36.819 v11.1.0*, Tables 7.3.1.2-3 and 7.3.1.2-4, September 2011.

and will not require a Universal Integrated Circuit Card (UICC) SIM (USIM) card. By operating on different channels in the ITS band, direct cellular V2X will be able to co-exist with IEEE 802.11p, another automotive communications protocol.

In the network communications mode, the system will use traditional cellular licensed spectrum.

Use cases include do-not-pass warnings, blind-curve hazard warnings, road-works warnings, blind-intersection assistance, bicyclist and pedestrian alerts, and left-turn assistance.

C-V2X is being designed to be compatible with other automotive standards, such as those from ETSI and the Society of Automotive Engineers.

User-Plane Congestion Management (UPCON)

With User-Plane Congestion Management, specified in Release 13, operators have additional tools to mitigate network congestion in specific coverage areas. Mechanisms include traffic prioritization by adjusting QoS for specific services; reducing traffic by, for example, compression; and limiting traffic, such as by prohibiting or deferring certain traffic.

3GPP specifications add a new architectural entity, called the “RAN Congestion Awareness Function” (RCAF), that determines whether a cell is congested, determines the UEs supported by that cell, and informs the Policy Control and Charging Rules Function (PCRF), which can subsequently apply different policies to mitigate the congestion.¹⁵⁰

Network-Assisted Interference Cancellation and Suppression (NAICS)

NAICS, a Release 13 capability, enhances the interference cancellation and suppression capability of UEs by using more information from the network. The fundamental goal of NAICS is to identify and cancel the dominant interferer, not an easy task when the dominant interferer can be on or off and can change in time and frequency. One analysis estimates an average performance gain of 7.4% relative to Release 11 Interference Rejection Combining and 11.7% at the cell edge.¹⁵¹ 5G Americas members expect even higher performance gains, for example 20%, with implementation-specific scheduling and as NAICS methods are refined.

Multi-User Superposition Transmission (MUST)

MUST, a study item in Release 13 and tentatively planned for Release 14 uses simultaneous transmissions of data for more than one UE within a cell without time, frequency, or spatial layer separation. The concept relies on a UE close to the base station having low propagation loss and a UE far from the base station having high propagation loss. The far UE is not aware of, nor interfered by the near UE transmission. The near UE cancels the far UE interference. The capacity gain grows with the SNR/SINR difference between the close and far UEs.

¹⁵⁰ For further details, see 3GPP TR 23.705, “Study on system enhancements for user plane congestion management (Release 13).”

¹⁵¹ Harri Holma, Antti Toskala, Jussi Reunanen, *LTE Small Cell Optimization: 3GPP Evolution to Release 13*, Jan 2016, Wiley, ISBN: 978-1-118-91257-7.

IPv4/IPv6

Release 8 defines support for IPv6 for both LTE and UMTS networks. An Evolved Packet System bearer can carry both IPv4 and IPv6 traffic, enabling a UE to communicate both IPv4 and IPv6 packets (assuming it has a dual stack) while connected through a single EPS bearer. It is up to the operator, however, whether to assign IPv4, IPv6, or both types of addresses to UE.

Communicating between IPv6-only devices and IPv4 endpoints will require protocol-conversion or proxies. For further details, refer to the 5G Americas white paper, "IPv6 – Transition Considerations for LTE and Evolved Packet Core," February 2009.

TDD Harmonization

3GPP developed LTE TDD to be fully harmonized with LTE FDD including alignment of frame structures, identical symbol-level numerology, the possibility of using similar Reference Signal patterns, and similar synchronization and control channels. Also, there is only one TDD variant. Furthermore, LTE TDD has been designed to co-exist with TD-SCDMA and TD-CDMA/UTRA (both low-chip rate and high-chip rate versions). LTE TDD achieves compatibility and co-existence with TD-SCDMA by defining frame structures in which the DL and UL time periods can be time aligned to prevent BTS to BTS and UE to UE interference to support operation in adjacent carriers without the need for large guardbands between the technologies. This will simplify deployment of LTE TDD in countries such as China that are deploying TD-SCDMA. Figure 72 demonstrates the synchronization between TC-SCDMA and LTE-TDD in adjacent channels.

Figure 72: TDD Frame Co-Existence between TD-SCDMA and LTE TDD¹⁵²

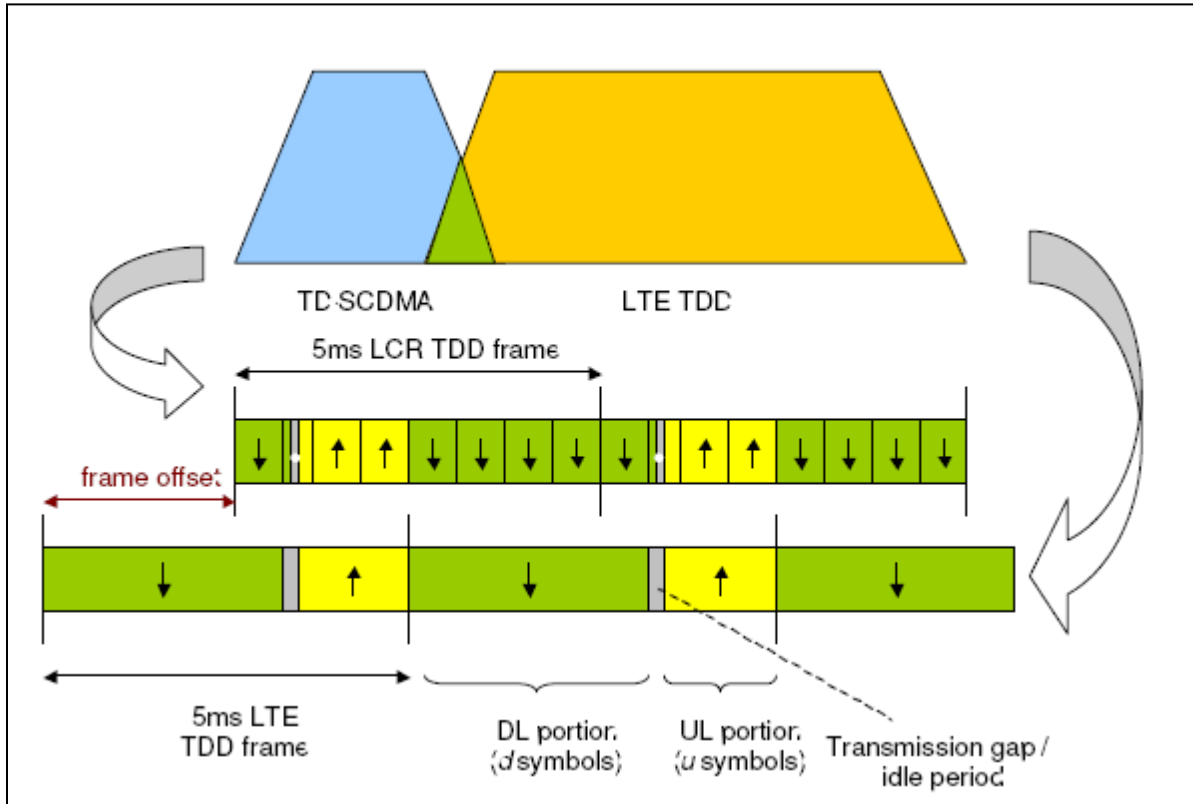

For LTE FDD and TDD to co-exist, large guardbands will be needed to prevent interference.

SMS in LTE

Even if an LTE network uses CSFB for voice, LTE devices will be able to send and receive SMS messages while on the LTE network. In this case, the 2G/3G core network will handle SMS messaging, but will tunnel the message to the MME in the EPC via the SGs interface. Once an LTE network uses IMS and VoLTE for packet voice service, SMS will be handled as SMS over IP and will use IMS infrastructure.¹⁵³

User Equipment Categories

LTE specifications define categories of UE, which mainly determine the maximum throughputs of devices but also govern the number of downlink MIMO layers, as shown in Table .

Higher throughput capabilities are possible with 64 QAM and 256 QAM modulation. 3GPP is also defining Category 0 and Category M devices for M2M, as discussed in the section "Internet of Things and Machine-to-Machines."

¹⁵² 5G Americas member company contribution.

¹⁵³ For further details, see 4G Americas, *Coexistence of GSM, HSPA and LTE*, May 2011, 35.

Table 19: UE Categories¹⁵⁴

UE Category	Max DL Throughput	Maximum DL MIMO Layers	Maximum UL Throughput
1	10.3 Mbps	1	5.2 Mbps
2	51.0 Mbps	2	25.5 Mbps
3	102.0 Mbps	2	51.0 Mbps
4	150.8 Mbps	2	51.0 Mbps
5	299.6 Mbps	4	75.4 Mbps
6	301.5 Mbps	2 or 4	51.0 Mbps
7	301.5 Mbps	2 or 4	102.0 Mbps
8	2998.6 Mbps	8	1497.8 Mbps
9	452.3 Mbps	2 or 4	51.0 Mbps
10	452.3 Mbps	2 or 4	102.0 Mbps
11	603.0 Mbps	2 or 4	51.0 Mbps
12	603.0 Mbps	2 or 4	102.0 Mbps
13	391.6 Mbps	2 or 4	150.8 Mbps
14	3916.6 Mbps	8	9587.7 Mbps
15	798.8 Mbps	2 or 4	226.1 Mbps
16	1051.4 Mbps	2 or 4	105.5 Mbps
17	2506.6 Mbps	8	2119.4 Mbps
18	1206.0 Mbps	2 or 4 (or 8)	211.0 Mbps
19	1658.3 Mbps	2 or 4 (or 8)	13563.9 Mbps

LTE-Advanced Relays

Another capability being planned for LTE-Advanced is relays, as shown in Figure 73.

The idea is to relay frames at an intermediate node, resulting in much better in-building penetration, and with better signal quality, user rates will improve. Relay nodes can also improve cell-edge performance by making it easier to add picocells at strategic locations.

¹⁵⁴ 3GPP, *Evolved Universal Terrestrial Radio Access (E-UTRA); User Equipment (UE) radio access capabilities*, Technical Specification 36.306 V14.2.0, March 2017.

Relays provide a means for lowering deployment costs in initial deployments in which usage is relatively low. As usage increases and spectrum needs to be allocated to access only, operators can then employ alternate backhaul schemes.

Figure 73: LTE-Advanced Relay¹⁵⁵

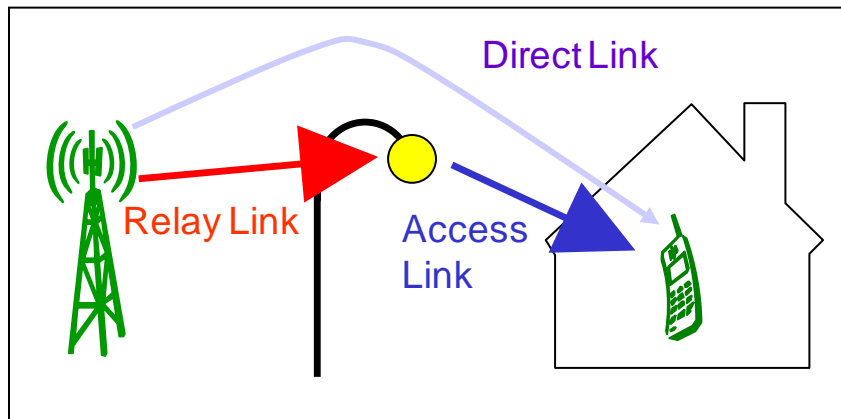

Proximity Services (Device-to-Device)

Release 12 defined a capability for devices to communicate directly with one another using LTE spectrum, a feature also called “operator-enabled proximity services.” With this capability, devices can autonomously discover nearby relevant devices and services in a battery-efficient manner. Devices broadcast their needs and services and can also passively identify services without user intervention. The communication between devices is called “sidelink communications” and uses an interface called “PC5.” Release 12, emphasizing public-safety applications, supports only one-to-many sidelink communications, whereas Release 13 supports one-to-one sidelink communications between two group member UEs and between a remote UE and a relay UE.

Initial emphasis of this capability, in both Release 12 and Release 13, is on public safety. Examples of potential consumer or commercial applications include discovering friends and family (social matching), push advertising for relevant notifications, tourist bulletins, venue services, crime alerts, home automation, vehicle-to-vehicle communication, and detecting children leaving the vicinity of their homes. The service is designed to work during infrastructure failures, even in emergencies and natural disasters. As a new means of communicating, proximity services could result in innovative types of applications.

The LTE network performs configuration and authentication; however, communication can be either via the network or directly between devices. To minimize battery consumption, devices synchronously wake up for brief intervals to discover services. The impact on LTE network capacity is minimal.

As with other location-based services, operators and application developers will need to address privacy concerns.

¹⁵⁵ 5G Americas member contribution.

LTE Throughput

The section “4G LTE Advances” above in the main section of the paper and “Data Throughput Comparison” in the appendix provide an overview of LTE throughputs. This section provides additional details.

Table shows initial (Release 8) LTE peak data rates based on different downlink and uplink designs.

Table20: LTE Peak Throughput Rates

LTE Configuration	Downlink (Mbps) Peak Data Rate	Uplink (Mbps) Peak Data Rate
Using 2X2 MIMO in the Downlink and 16 QAM in the Uplink, 10+10 MHz	70.0	22.0
Using 4X4 MIMO in the Downlink and 64 QAM in the Uplink, 20+20 MHz	300.0	71.0

LTE is not only efficient for data but, because of a highly efficient uplink, is extremely efficient for VoIP traffic. As discussed in the “Spectral Efficiency” section above, in 10+10 MHz of spectrum, LTE VoIP capacity will reach 500 users.¹⁵⁶

Table 19 analyzes LTE median and average throughput values in greater detail for different LTE configurations.

Table 19: LTE FDD User Throughputs Based on Simulation Analysis¹⁵⁷

Configuration	User Throughput, Mbps			
	Downlink (DL)		Uplink (UL)	
	Median	Average	Median	Average
LTE FDD: Low Band, 2x2 MIMO-DL, 1x2 SIMO-UL, 10+10 MHz, R8	8.6	10.9	4.5	5.0
LTE FDD: High Band, 4x2 MIMO-DL, 1x4 SIMO-UL, 10+10 MHz, R8	10.6	12.2	5.4	6.4
LTE FDD: High Band, 2x2 MIMO-DL, 1x2 SIMO UL, 20+20 MHz, R8	15.2	17.9	5.4	7.0
LTE FDD: High Band, 4x4 MIMO-DL, 1x4 SIMO UL, 20+20 MHz, R12	25.4	29.2	6.9	9.1

¹⁵⁶ 3GPP Multi-member analysis.

¹⁵⁷ 5G Americas member contribution. SIMO refers to Single Input Multiple Output antenna configuration, which in the uplink means one transmit antenna at the UE and multiple receive antennas at the eNodeB.

The simulation results represent a consensus view of 5G Americas members working on this white paper project. The goal of the analysis was to quantify LTE throughputs in realistic deployments. Simulation assumptions include:

- ❑ Traffic is FTP-like at a 50% load with a 75/25 mix of indoor/outdoor users.
- ❑ Throughput is at the medium-access control (MAC) protocol layer. (Application-layer throughputs may be 5 to 8 percent lower due to protocol overhead.)
- ❑ The 3GPP specification release numbers shown correspond to the infrastructure capability.
- ❑ The configuration in the first row corresponds to low-frequency band operation, representative of 700 MHz or cellular, while the remaining configurations assume high-frequency band operation, representative of PCS, AWS, or WCS. (Higher frequencies facilitate higher-order MIMO configurations and have wider radio channels available.)
- ❑ The downlink value for the first row corresponds to Release 8 device-receive capability (Minimum Mean Square Error [MMSE]), while the values in the other rows correspond to Release 11 device-receive capability (MMSE – Interference Rejection Combining [IRC]).
- ❑ The uplink value for the first row corresponds to a Maximal Ratio Combining (MRC) receiver at the eNodeB, while the remaining values correspond to an IRC receiver.
- ❑ Low-band operation assumes 1,732-meter inter-site distance, while high-band operation assumes 500-meter ISD. The remaining simulation assumptions are listed in Table 20.

Table 20: LTE FDD User Throughput Simulation Assumptions¹⁵⁸

Parameter	Value
Frequency	Low Band (LB): B17; High Band (HB): B30
Channel bandwidth	10 MHz, 20 MHz
System configuration	DL: 2x2, 4x2, and 4x4 Closed-Loop (CL) MIMO UL: 1x2 and 1x4 SIMO
Traffic type	FTP model 2: File size = 0.15 Mbyte, 1 second inter-arrival time, Load varied by changing number of users
Inter-Site Distance (ISD)	LB: 1732 m; HB: 500 m
Pathloss model	LB: HATA; HB: COST231 with correction
eNodeB transmit power	LB: 60 watts total; HB: 80 watts total
eNodeB antenna type	2 Tx = +45 degrees cross-pol (DIV-1X); 4 Tx = Closely separated pair of cross-pols (CLA-2X)
eNodeB antenna gain	LB: 14.8 dBi; HB: 17.5 dBi
eNodeB antenna pattern	Actual antenna patterns as used in RF planning tool
eNodeB Rx type	LB: MRC; HB: IRC
Downtilt	LB: 7 degrees; HB: 9 degrees
Penetration loss	75/25 mix of indoor/outdoor users LB: 12 dB for indoor users; HB: 22 dB for indoor users
Device speed	3 km/h all users
Channel model	Modified SCME-WINNER+, LB: Suburban Macro (SMa) scenario; HB: Urban Macro (UMa)
Device antenna type	+45 degrees cross-pol with built in correlation of 0.5
Device antenna gain and mismatch	LB: -5 dBi and 3 dB; HB: -3 dBi and 3 dB
Device body loss	3 dB for both bands
Device Rx type	MMSE, MMSE-IRC
Uplink power control	LB: alpha = 1, Po = -100 dBm; HB: alpha = 0.9, Po = -100 dBm
Scheduler	Proportional fair, frequency selective

The assumptions, emphasizing realistic deployments, do not necessarily match assumptions used by other organizations, such as 3GPP, so results may differ.

Additional insight into LTE performance under different configuration comes from a test performed on a cluster of cells in an LTE operator's network, comparing downlink performance of 4X2 MIMO against 2X2 MIMO, and uplink performance of 1X4 SIMO against 1X2 SIMO. The test employed LTE category 4 devices.¹⁵⁹

¹⁵⁸ 5G Americas member contribution.

¹⁵⁹ 5G Americas member contribution.

These tests, which were performed in a 20+20 MHz cluster, show significant improvements in cell edge uplink and downlink throughput, in addition to an overall increase in uplink and downlink throughputs. Specific results include:

- ❑ A 100% increase in uplink throughput at the cell edge with 1X4 SIMO compared to 1x2 SIMO.
- ❑ A 40% increase in downlink throughput at the cell edge with 4x2 closed-loop MIMO compared to 2x2 open-loop MIMO.
- ❑ A 50 to 75% increase in downlink throughput with closed loop MIMO compared to transmit diversity modes.
- ❑ Up to 6dB gains in uplink transmit power with 1X4 SIMO, which directly translates into UE battery savings.
- ❑ Peak speeds of 144 Mbps with 4X2 MIMO in the downlink and 47 Mbps with 1X4 SIMO in the uplink.

Another LTE operator's testing results for LTE in a TDD configuration, using 20 MHz channels, 3:2 DL to UL ratio, and category 3 devices, showed:

- ❑ Peak speeds of 55 Mbps.
- ❑ Typical speeds of 6 to 15 Mbps.¹⁶⁰

Figure 74 shows the result of a drive test in a commercial LTE network with a 10 MHz downlink carrier demonstrating 20 Mbps to 50 Mbps throughput rates across much of the coverage area. Throughput rates would double with a 20+20 MHz configuration.

¹⁶⁰ 5G Americas member contribution.

Figure 74: Drive Test of Commercial European LTE Network (10+10 MHz)¹⁶¹



¹⁶¹ Ericsson contribution.

Figure 75 provides additional insight into LTE downlink throughput, showing Layer 1 throughput simulated at 10 MHz bandwidth using the Extended Vehicular A 3 km/hour channel model. The figure shows the increased performance obtained with the addition of different orders of MIMO. Note how throughput improves based on higher signal to noise ratio (SNR).

Figure 75: LTE Throughput in Various Modes¹⁶²

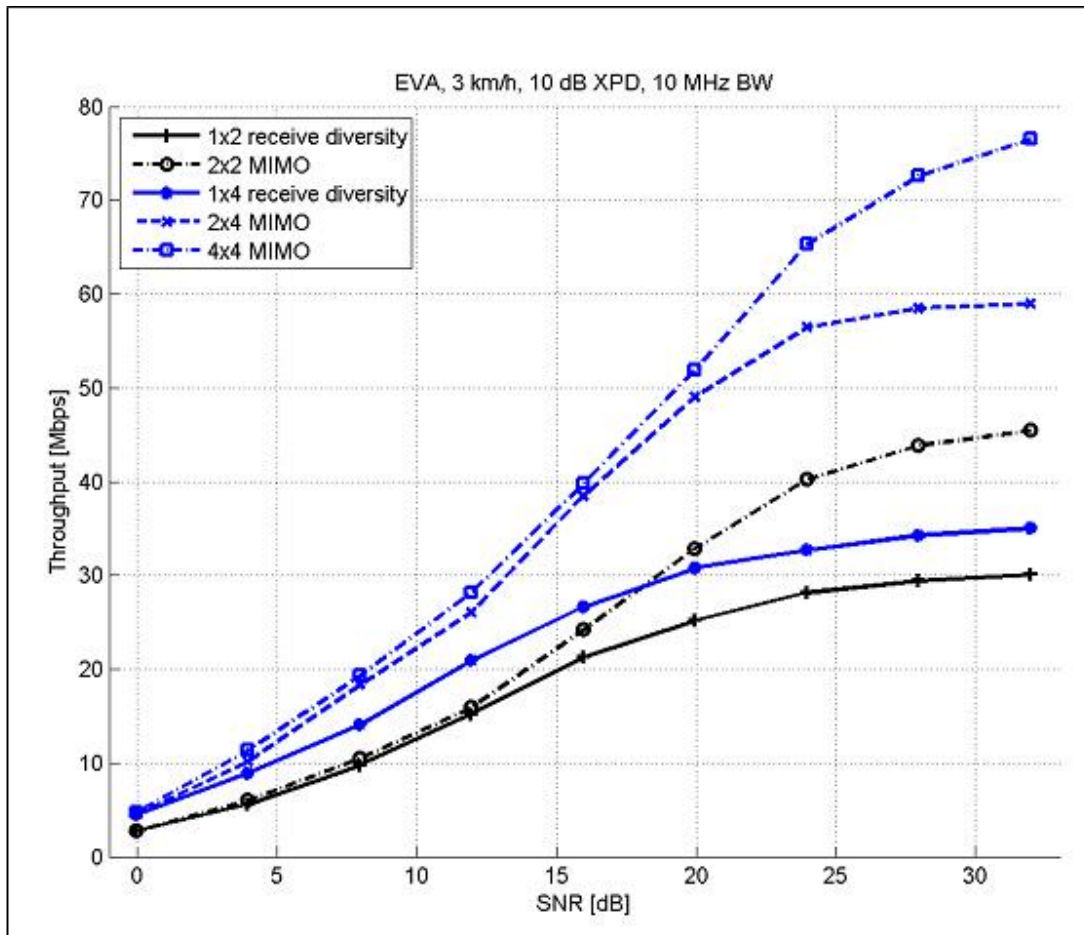

Actual throughput rates that users experience are lower than the peak rates and depend on a variety of factors:

- ❑ **RF Conditions and User Speed.** Peak rates depend on optimal conditions. Suboptimal conditions include being at the edge of the cell or moving at high speed, resulting in lower throughput.
- ❑ **Network Loading.** Like all wireless systems, throughput rates go down as more devices simultaneously use the network. Throughput degradation is linear.

¹⁶² Jonas Karlsson, Mathias Refback, "Initial Field Performance Measurements of LTE," *Ericsson Review*, No. 3, 2008.

Figure 76 shows how dramatically throughput rates can vary by number of active users and radio conditions. The higher curves are for better radio conditions.

Figure 76: LTE Actual Throughput Rates Based on Conditions¹⁶³

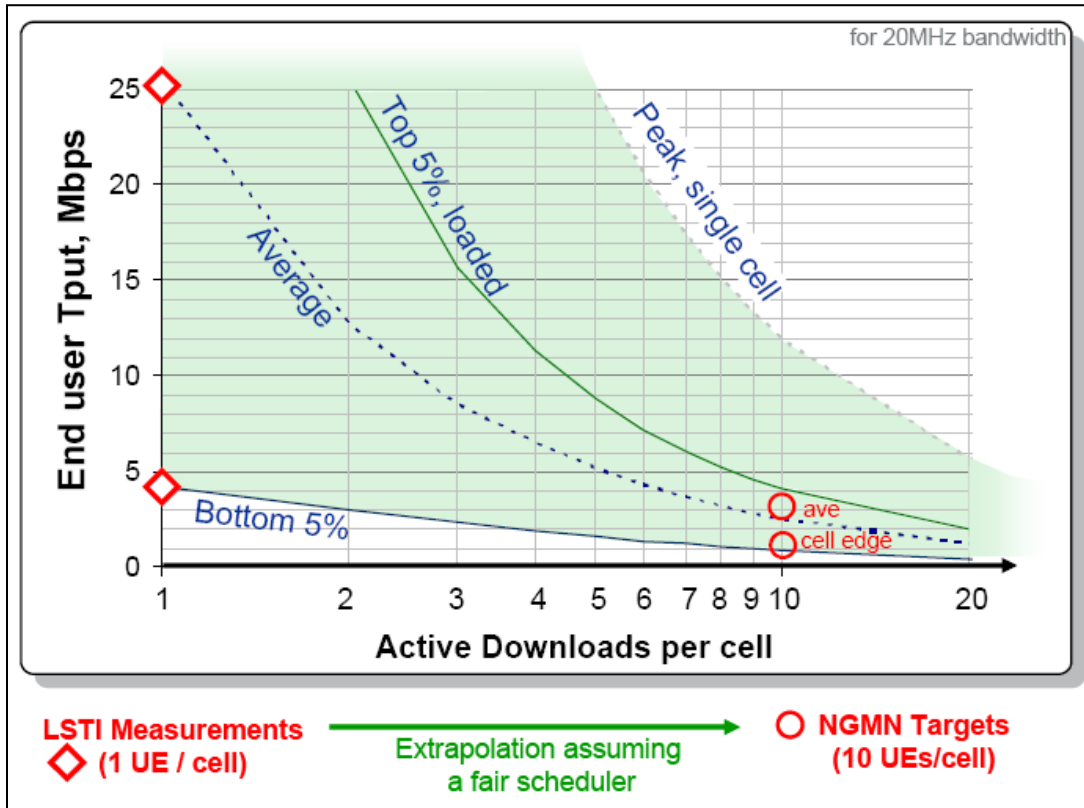

¹⁶³ LTE/SAE Trial Initiative, "Latest Results from the LSTI, Feb 2009," <http://www.lstiforum.org>.

VoLTE and RCS

This paper introduced VoLTE and voice support in the earlier section, “VoLTE, RCS, WebRTC, and Wi-Fi Calling.” This section in the appendix provides additional technical detail about the operation of VoLTE and RCS.

Voice in LTE can encompass: no voice support, voice implemented in a circuit-switched fallback (CSFB) mode using 2G or 3G, and VoIP implemented with IMS.

Initial LTE network deployments used CSFB, with which the LTE network carries circuit-switched signaling over LTE interfaces, allowing the subscriber to be registered with the 2G/3G MSC even while on the LTE network. When there is a CS event, such as an incoming voice call, the MSC sends the page to the LTE core network, which delivers it to the subscriber device. The device then switches to 2G/3G operation to answer the call.

Voice over LTE using VoIP requires IMS infrastructure. To facilitate IMS-based voice, vendors and operators created the One Voice initiative to define required baseline functionality for user equipment, the LTE access network, the Evolved Packet Core, and the IMS. GSMA adopted the One Voice initiative in what it calls VoLTE, specified in GSMA reference document IR.92.¹⁶⁴ GSMA specifies interconnection and international roaming among LTE networks through the IR.88¹⁶⁵ specification. Another specification, IR.94, provides the IMS Profile for Conversational Video Service, a service referred to as “Video over LTE” (ViLTE).¹⁶⁶

For a phone to support VoLTE, it needs software implementing the IMS protocol stack. For example, the iPhone 6 was the first iPhone to implement such software. Additional software implementing RCS application programming interfaces can provide applications with access to IMS-based services, such as voice, messaging, and video. The Open Mobile Alliance has defined RESTful network APIs for RCS that support the following functions: notification channel, chat, file transfer, third-party calls, call notification, video sharing, image sharing, and capability discovery. As shown in Figure 77, over time, new profile releases will broaden the scope of these APIs.

¹⁶⁴ GSMA, “IMS Profile for Voice and SMS,” Document IR.92. Available at <http://www.gsma.com/newsroom/wp-content/uploads/2013/04/IR.92-v7.0.pdf>.

¹⁶⁵ GSMA, “LTE Roaming Guidelines,” GSMA Document IR.88. Available at <http://www.gsma.com/newsroom/wp-content/uploads/2013/04/IR.88-v9.0.pdf>.

¹⁶⁶ GSMA, “IMS Profile for Conversational Video Service,” Document IR.94. Available at <http://www.gsma.com/newsroom/all-documents/ir-94-ims-profile-for-conversational-video-service/>.

Figure 77: Evolution of RCS API Profiles¹⁶⁷

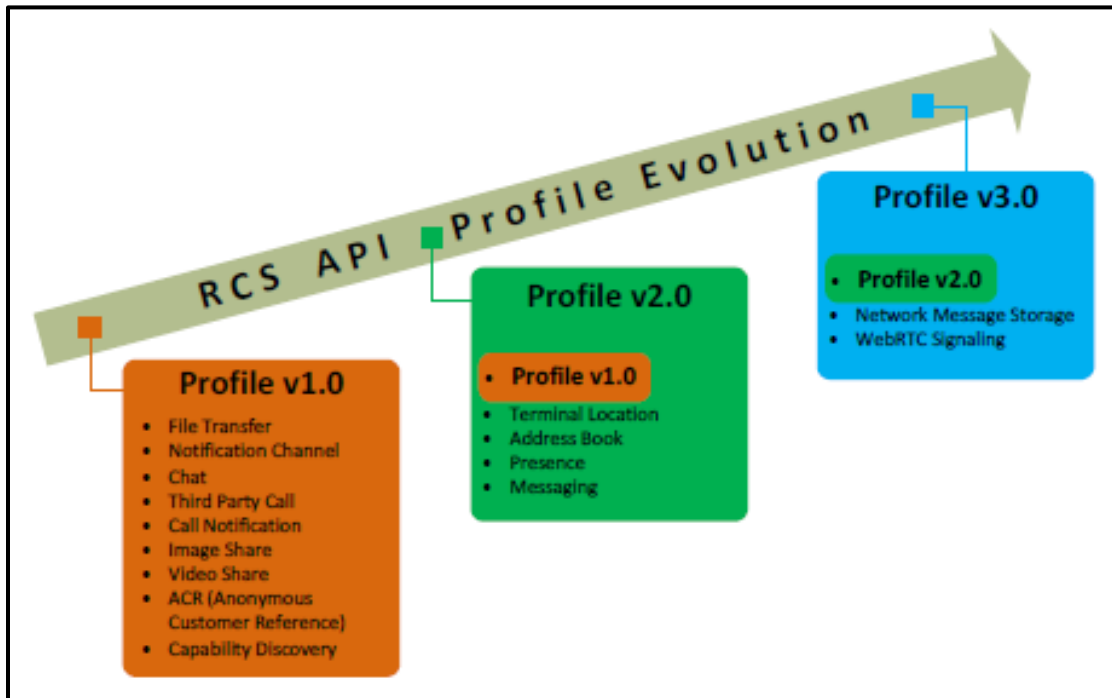

LTE VoIP leverages the QoS capabilities defined for EPC, which specify different quality classes. Features available in LTE to make voice operation more efficient include Semi-Persistent Scheduling (SPS) and TTI bundling. SPS reduces control channel overhead for applications (like VoIP) that require a persistent radio resource. Meanwhile, TTI bundling improves subframe utilization by reducing IP overhead, while in the process optimizing uplink coverage.

Another way to increase voice capacity in LTE and to support operation in congestion situations is vocoder rate adaptation, a mechanism with which operators can control the codec rate based on network load, thus dynamically trading off voice quality against capacity.

VoLTE roaming across operators will require network-to-network interfaces between their respective IMS networks. Such roaming and interconnect will follow initial VoLTE deployments. Different IMS stack implementations between vendors will also complicate roaming.

One roaming consideration is how operators handle data roaming. LTE roaming can send all visited network traffic back to the home network, which for a voice call, increases voice latency. For voice calls, the local breakout option would mitigate this latency.

Using Single-Radio Voice Call Continuity (SR-VCC) and Enhanced SR-VCC (eSRVCC), user equipment can switch mid-call to a circuit-switched network, in the event that the user moves out of LTE coverage. Similarly, data sessions can be handed over in what is called "Packet-Switched Handover" (PSHO).

¹⁶⁷ 4G Americas, *VoLTE and RCS Technology – Evolution and Ecosystem*, Nov. 2014.

Figure 78 shows how an LTE network might evolve in three stages. Initially, LTE performs only data service, and the underlying 2G/3G network provides voice service via CSFB. In the second stage, voice over LTE is available, but LTE covers only a portion of the total 2G/3G coverage area. Hence, voice in 2G/3G can occur via CSFB or SR-VCC. Eventually, LTE coverage will match 2G/3G coverage, and LTE devices will use only the LTE network.

Figure 78: Evolution of Voice in an LTE Network¹⁶⁸

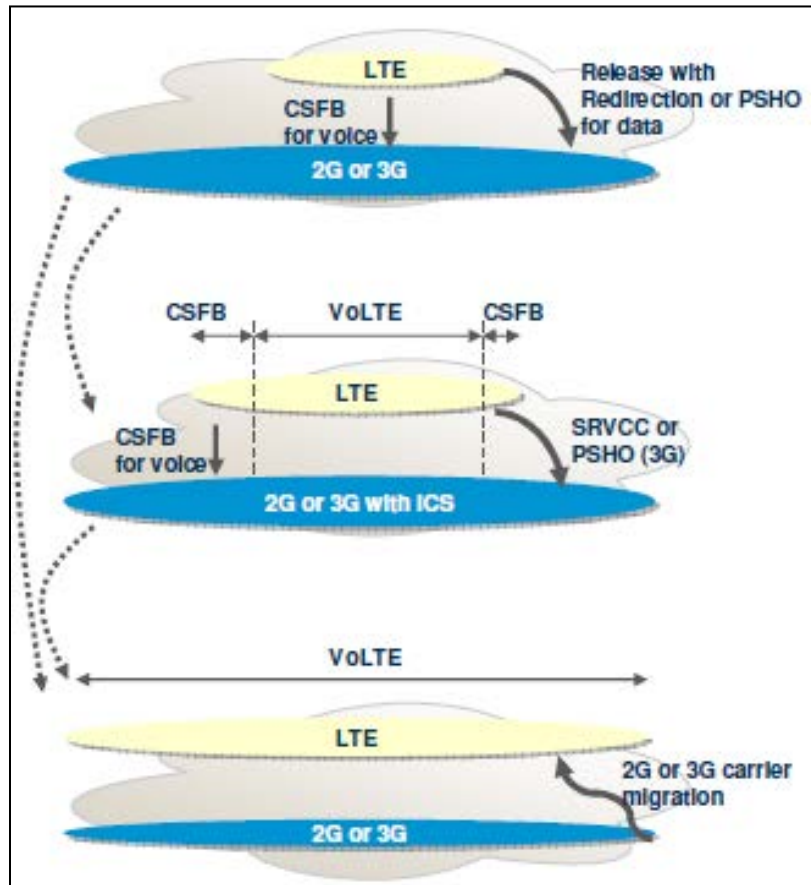

Another voice approach, called "Voice over LTE via Generic Access" (VoLGA), defined circuit-switched operation through an LTE IP tunnel. 3GPP, however, has stopped official standards work that would support VoLGA.

3GPP has developed a new codec, called "Enhanced Voice Services" (EVS), which will include super-wideband voice capability. For the same bit rate, EVS provides higher voice quality than the other codecs.¹⁶⁹ Table 21 summarizes the features and parameters of the three 3GPP codecs used in LTE.

¹⁶⁸ 5G Americas member contribution.

¹⁶⁹ See Figure 9.2. 3GPP, *TR 26.952 V12.1.0, Codec for Enhanced Voice Services (EVS); Performance Characterization*, March 2015.

Table 21: Comparison of AMR, AMR-WB and EVS Codecs¹⁷⁰

Features	AMR	AMR-WB	EVS
Input and output sampling frequencies supported	8KHz	16KHz	8KHz, 16KHz, 32KHz, 48 KHz
Audio bandwidth	Narrowband	Wideband	Narrowband, Wideband, Super-wideband, Fullband
Coding capabilities	Optimized for coding human voice signals	Optimized for coding human voice signals	Optimized for coding human voice and general-purpose audio (music, ringtones, mixed content) signals
Bit rates supported (in kb/s)	4.75, 5.15, 5.90, 6.70, 7.4, 7.95, 10.20, 12.20	6.6, 8.85, 12.65, 14.25, 15.85, 18.25, 19.85, 23.05, 23.85	5.9, 7.2, 8, 9.6 (NB and WB only), 13.2 (NB, WB and SWB), 16.4, 24.4, 32, 48, 64, 96, 128 (WB and SWB only)
Number of audio channels	Mono	Mono	Mono and Stereo
Frame size	20 ms	20 ms	20 ms
Algorithmic Delay	20-25 ms	25 ms	Up to 32 ms

Figure 79 shows mean opinion scores (MOS) for different codecs at different bit rates, illustrating the advantage of EVS, particularly for bit rates below 32 kbps that cellular networks use.

¹⁷⁰ 4G Americas, *Mobile Broadband Evolution: Rel-12 & Rel-13 and Beyond*, 2015. See also T-Mobile 2016 EVS announcement: <https://newsroom.t-mobile.com/news-and-blogs/volte-enhanced-voice-services.htm>.

Figure 79: Combined Mean Opinion Score Values¹⁷¹

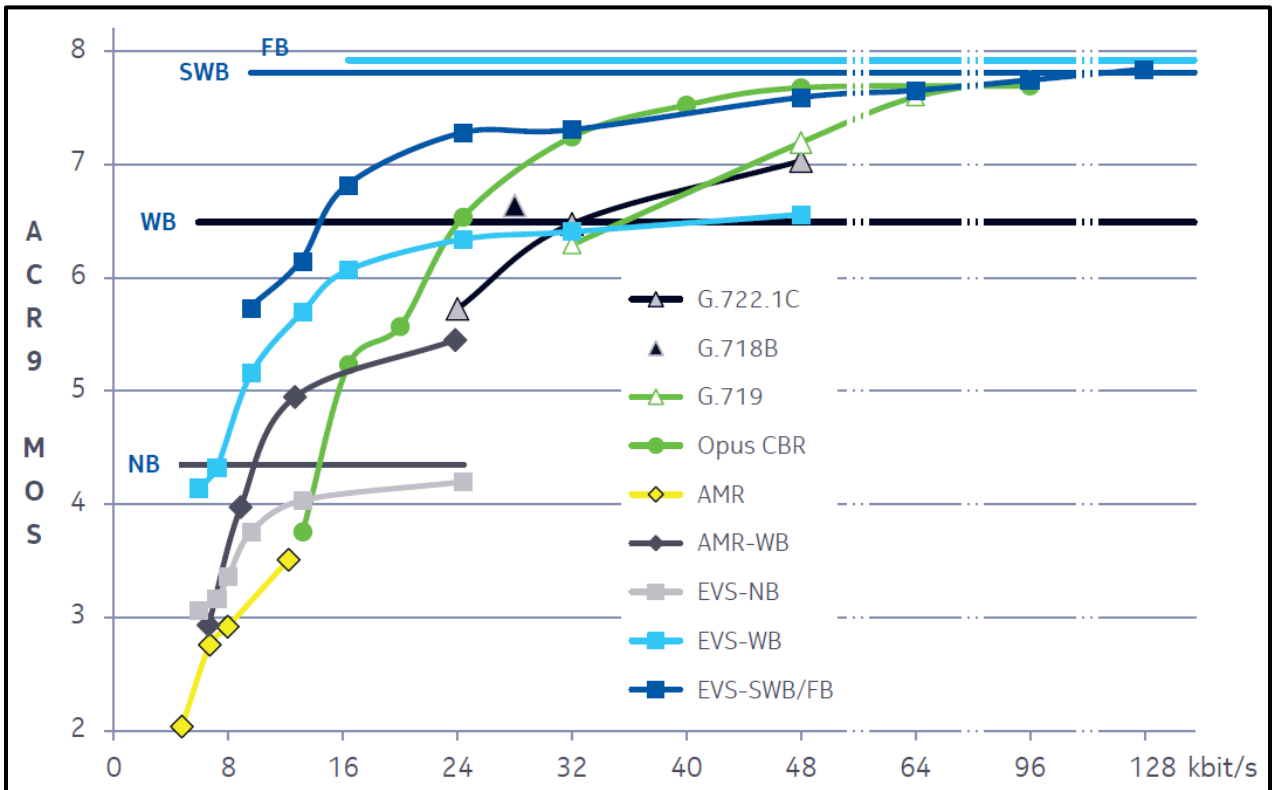

Table 22 shows EVS (narrowband, wideband, super-wideband) audio bandwidths and bitrates that create subjective quality equal to or better than AMR or AMR-WB for typical conversational voice scenarios.

Table 22: EVS Compared to AMR and AMR-WB¹⁷²

Reference	Equal bandwidth	Wider bandwidth
AMR 12.2 kbit/s	EVS-NB 8.0 kbit/s	EVS-WB 5.9 kbit/s
AMR-WB 12.65 kbit/s	EVS-WB 9.6 kbit/s	EVS-SWB 9.6 kbit/s
AMR-WB 23.85 kbit/s	EVS-WB 13.2 kbit/s	EVS-SWB 9.6 kbit/s

Figure 80 compares EVS capacity gains over AMR and AMR-WB for the references cases shown in Table 22. EVS-SWB at 9.6 kbps almost doubles voice capacity compared to AMW-WB at 23.85 kbps.

¹⁷¹ Nokia, *The 3GPP Enhanced Voice Services (EVS) codec*, 2015.

¹⁷² Ibid.

Figure 80: EVS Voice Capacity Compared to AMR and AMR-WB¹⁷³

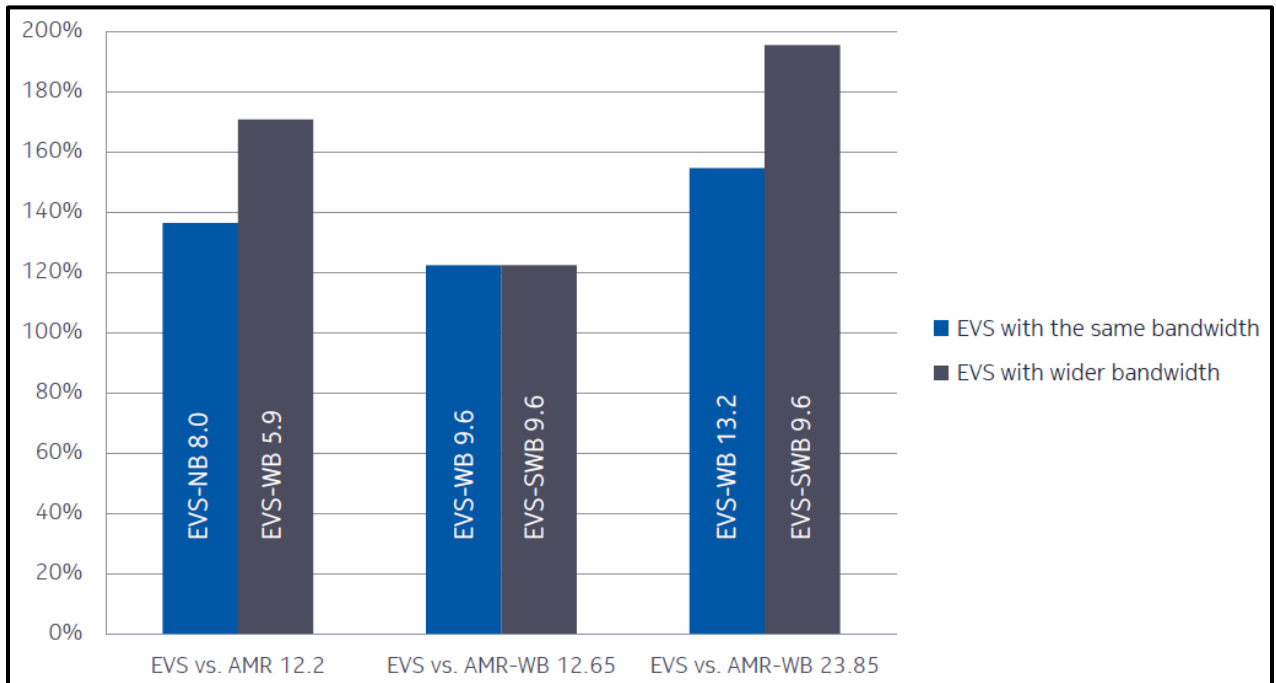

LTE Ultra-Reliable and Low-Latency Communications

The 3GPP work item for this feature states, “3GPP LTE technology enhancements are needed to serve such new use cases and to remain technologically competitive up to and beyond 2020. As a candidate technology for ITU IMT-2020 submission, it is motivated to further enhance the LTE system such that it can meet the key IMT-2020 requirements including those for URLLC in terms of reliability ($1-10^{-5}$ reliability for small data packets within a latency of 1ms) as well as latency ($\leq 1\text{ms}$ one way user plane latency).”¹⁷⁴

Evolved Packet Core (EPC)

3GPP defined the Evolved Packet Core (EPC) in Release 8 as a framework for an evolution or migration of the network to a higher-data-rate, lower latency, packet-optimized system that supports multiple radio-access technologies including LTE, as well as and legacy GSM/EDGE and UMTS/HSPA networks. EPC also integrates CDMA2000 networks and Wi-Fi.

EPC is optimized for all services to be delivered via IP in a manner that is as efficient as possible—through minimization of latency within the system, for example. It also provides service continuity across heterogeneous networks, which is important for LTE operators who must simultaneously support GSM-HSPA customers.

One important performance-enhancing aspect of EPC is a flatter architecture. For packet flow, EPC includes two network elements, called “Evolved Node B” (eNodeB) and the Access Gateway (AGW). The eNodeB (base station) integrates the functions traditionally

¹⁷³ Ibid.

¹⁷⁴ RP-170796, 3GPP Work Item Description, “Ultra Reliable Low Latency Communication for LTE,” March 2017.

- ❑ The PDN gateway that controls IP data services, does routing, allocates IP addresses, enforces policy, and provides access for non-3GPP access networks.
- ❑ The MME that supports user equipment context and identity, as well as authenticating and authorizing users.
- ❑ The Policy Control and Charging Rules Function that manages QoS aspects.

QoS in EPS employs the QoS Class Identifier (QCI), a number denoting a set of transport characteristics (bearer with/without guaranteed bit rate, priority, packet delay budget, packet error loss rate) and used to infer nodes specific parameters that control packet forwarding treatment (such as scheduling weights, admission thresholds, queue management thresholds, or link-layer protocol configuration). The network maps each packet flow to a single QCI value (nine are defined in the Release 8 version of the specification) according to the level of service required by the application. Use of the QCI avoids the transmission of a full set of QoS-related parameters over the network interfaces and reduces the complexity of QoS negotiation. The QCI, together with Allocation Retention Priority (ARP) and, if applicable, Guaranteed Bit Rate (GBR) and Maximum Bit Rate (MBR), determines the QoS associated to an EPS bearer. A mapping between EPS and pre-Release 8 QoS parameters permits interworking with legacy networks.

The QoS architecture in EPC enables a number of important capabilities for both operators and users:

- ❑ **VoIP support with IMS.** QoS is a crucial element for providing LTE/IMS voice service. (See section below on IMS).
- ❑ **Enhanced application performance.** Applications such as gaming or video can operate more reliably.
- ❑ **More flexible business models.** With flexible, policy-based charging control, operators and third parties will be able to offer content in creative new ways. For example, an enhanced video stream to a user could be paid for by an advertiser.
- ❑ **Congestion control.** In congestion situations, certain traffic flows (bulk transfers, abusive users) can be throttled down to provide a better user experience for others.

Table 23 shows the nine QCI used by LTE.

Table 23: LTE Quality of Service

QCI	Resource Type	Priority	Delay Budget	Packet Loss	Examples
1	GBR (Guaranteed Bit Rate)	2	100 msec.	10^{-2}	Conversational voice
2	GBR	4	150 msec.	10^{-3}	Conversational video (live streaming)
3	GBR	3	50 msec.	10^{-3}	Real-time gaming
4	GBR	5	300 msec.	10^{-6}	Non-conversational video (buffered streaming)
5	Non-GBR	1	100 msec.	10^{-6}	IMS signaling

QCI	Resource Type	Priority	Delay Budget	Packet Loss	Examples
6	Non-GBR	6	300 msec.	10^{-6}	Video (buffered streaming), TCP Web, email, and FTP
7	Non-GBR	7	100 msec.	10^{-3}	Voice, video (live streaming), interactive gaming
8	Non-GBR	8	300 msec.	10^{-6}	Premium bearer for video (buffered streaming), TCP Web, e-mail, and FTP
9	Non-GBR	9	300 msec.	10^{-6}	Default bearer for video, TCP for non-privileged users

Heterogeneous Networks and Small Cells

A fundamental concept in the evolution of next-generation networks is the blending of multiple types of networks to create a “network of networks” characterized by:

- ❑ Variations in coverage areas, including femtocells (either enterprise femtos or home femtos, called HeNBs), picocells (also referred to as metro cells), and macro cells. Cell range can vary from 10 meters to 50 kilometers.
- ❑ Different frequency bands.
- ❑ Different technologies spanning Wi-Fi, 2G, 3G, 4G, and 5G.
- ❑ Relaying capability in which wireless links can serve as backhaul.

Figure 82 shows how user equipment might access different network layers.

Figure 82: Load Balancing with Heterogeneous Networks¹⁷⁵

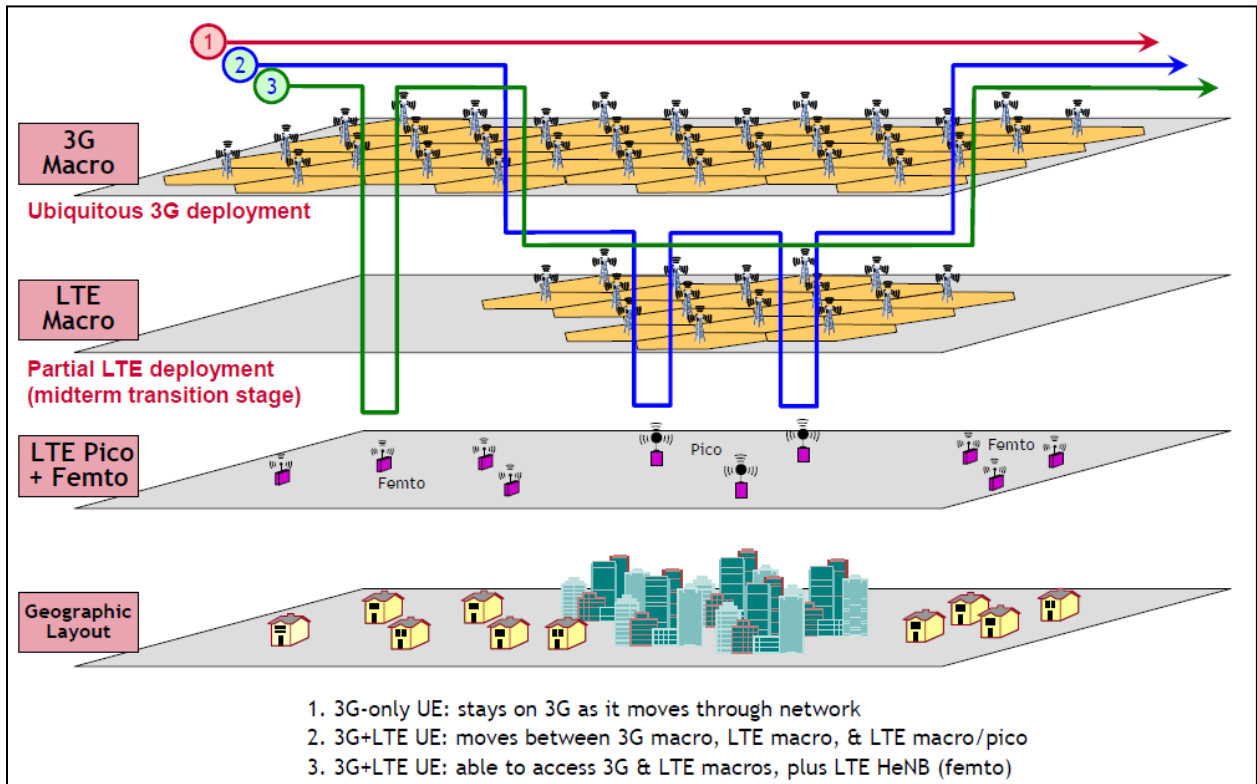

HetNets will allow significant capacity expansion in configurations in which operators can add picocells to coverage areas served by macrocells, particularly if there are hot spots with higher user densities.

Small cells differentiate themselves from macrocells according to the parameters shown in Table 24.

Table 24: Small Cell Vs. Macro Cell Parameters: Typical Values

Parameter	Small Cell	Macro Cell
Transmission Power	24 dBm (0.25 W)	43 dBm (20 W)
Antenna Gain	2 dBi	15 dBi
Users	Tens	Hundreds
Mobility	30 km/hr	350 km/hr

¹⁷⁵ 5G Americas member contribution.

Whether or not the small cell uses the same radio carriers as the macro cell involves multiple tradeoffs. In Figure 83 Scenario 1, the small cells and macro cell use different radio carriers, the two not interfering with each other. Although this configuration requires more spectrum, the small cells are able to cover larger areas than if they were deployed using the same radio carrier as the macro. This configuration supports medium-to-high penetration levels of small cells, allowing the network to reach huge capacity.

In Scenario 2, the small cells and macro cells use the same radio carrier, accommodating operators with more limited spectrum, but the network must manage interference using the techniques discussed below. Operators must carefully manage small-cell transmission power in this configuration.

Figure 83: Scenarios for Radio Carriers in Small Cells

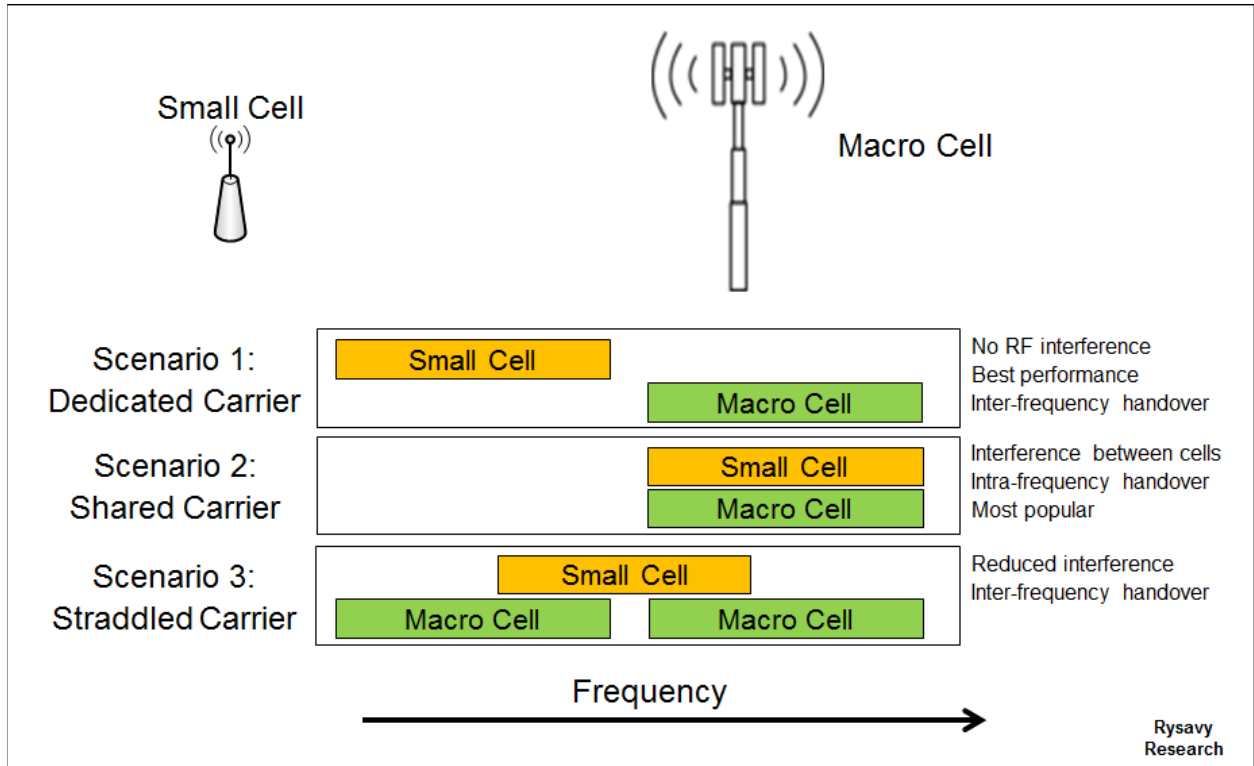

In Scenario 3, the small cells use a straddled radio carrier, accommodating operators with more spectrum, but the network still needs to manage interference using techniques discussed below. Compared with a shared carrier configuration, this configuration has benefits similar to dedicated carriers in terms of radio-parameter planning and reduced interference.

Figure 84 shows two different traffic distribution scenarios, with a uniform distribution of devices in the first and higher densities serviced by picocells in the second. The second scenario can result in significant capacity gains as well as improved user throughput.

Figure 84: Different Traffic Distributions Scenarios

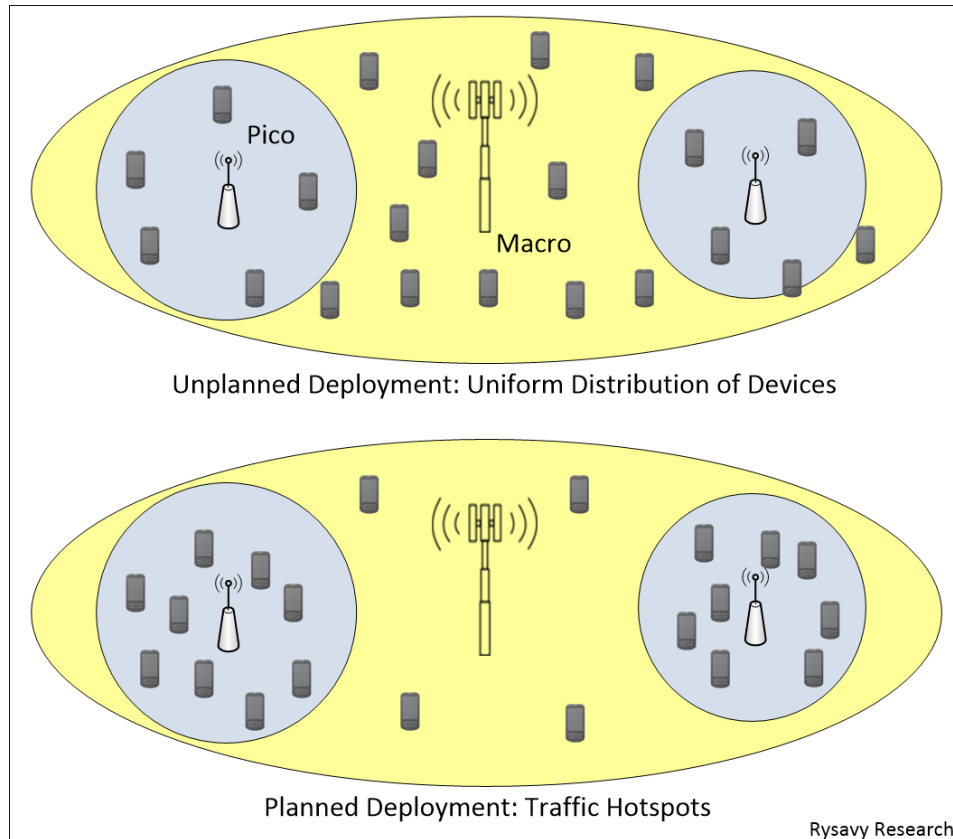

One vendor calculated expected HetNet gains assuming no eICIC, no picocell range extension, and no eICIC. For the case of four picocells without picocell range extension and uniform user distribution, the median-user-throughput gain compared with a macro-only configuration was 85%. For a similar case of four picocells but using a hotspot user distribution, the gain was much higher, 467%.¹⁷⁶ Additional gains will occur with picocell range extension.

Expected picocell gains rise proportionally to the number of picocells, so long as a sufficient number of UEs connect to the picocells.

Release 10 and Release 11 added enhanced support to manage the interference in the HetNet scenario in the time domain with Enhanced Inter-cell Interference Coordination (eICIC) and Further Enhanced Inter-cell Interference Coordination (feICIC), as well as in the frequency domain with carrier-aggregation-based ICIC.

HetNet capability keeps becoming more sophisticated through successive 3GPP releases as summarized in Table 25.

¹⁷⁶ 5G Americas member contribution. Further assumes 2X1 W picocell transmit power, cell-edge placement (planned picocell deployment), 67% of all the users within 40m of the pico locations, and 3GPP Technical Report 36.814 adapted to 700 MHz.

Table 25: 3GPP HetNet Evolution

3GPP Release	HetNet Feature
8	Initial SON capabilities, most for auto configuration. Initial intercell interference coordination (ICIC) available.
9	More mobility options (for example, handover between HeNBs), operator customer subscriber group (SCG) lists, load-balancing, coverage and capacity improvements.
10	An interface for HeNBs, called "Iurh," that improves coordination and synchronization, LTE time domain eICIC. Carrier-aggregation-based ICIC also defined.
11	Improved eICIC, further mobility enhancements.

Enhanced Intercell Interference Coordination

Significant challenges must be addressed in these heterogeneous networks. One is near-far effects, in which local small-cell signals can easily interfere with macro cells if they are using the same radio carriers.

Interference management is of particular concern in HetNets since, by design, coverage areas of small coverage cells overlap with the macro cell. Beginning with Release 10, eICIC introduces an approach of almost-blank subframes by which subframe transmission can be muted to prevent interference. Figure 85 illustrates eICIC for the macro layer and pico layer coordination. If a UE is on a picocell but in a location where it is sensitive to interference from the macro layer, the macro layer can mute its transmission during specific frames when the pico layer is transmitting.

Figure 85: Example of Enhanced Inter-cell Interference Coordination¹⁷⁷

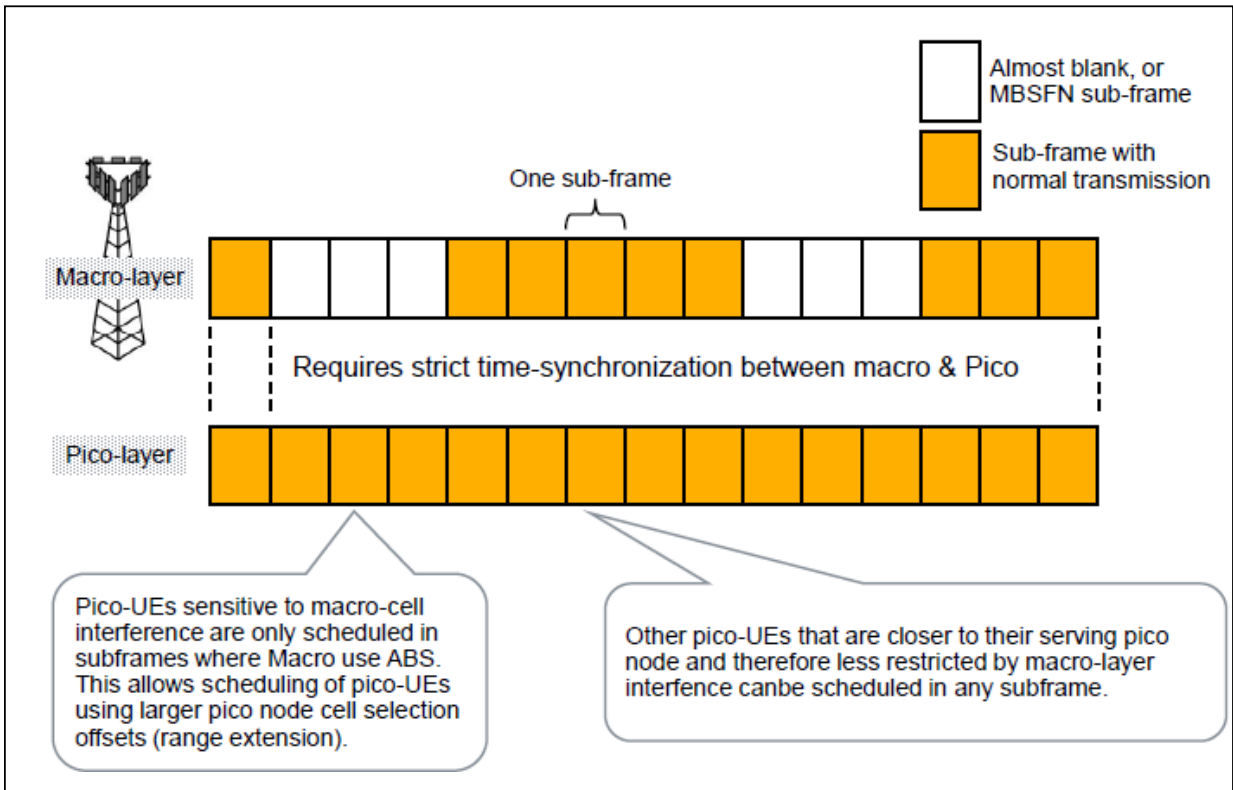

LTE can also combine eICIC with interference-cancellation-based devices to minimize the harmful effects of interference between picocells and macro cells.

Figure 86 shows one 4G America member's analysis of anticipated median throughput gains using picocells and Release 11 Further Enhanced ICIC.

¹⁷⁷ 5G Americas member contribution.

Figure 86: Median Throughput Gains in Hotspot Scenarios¹⁷⁸

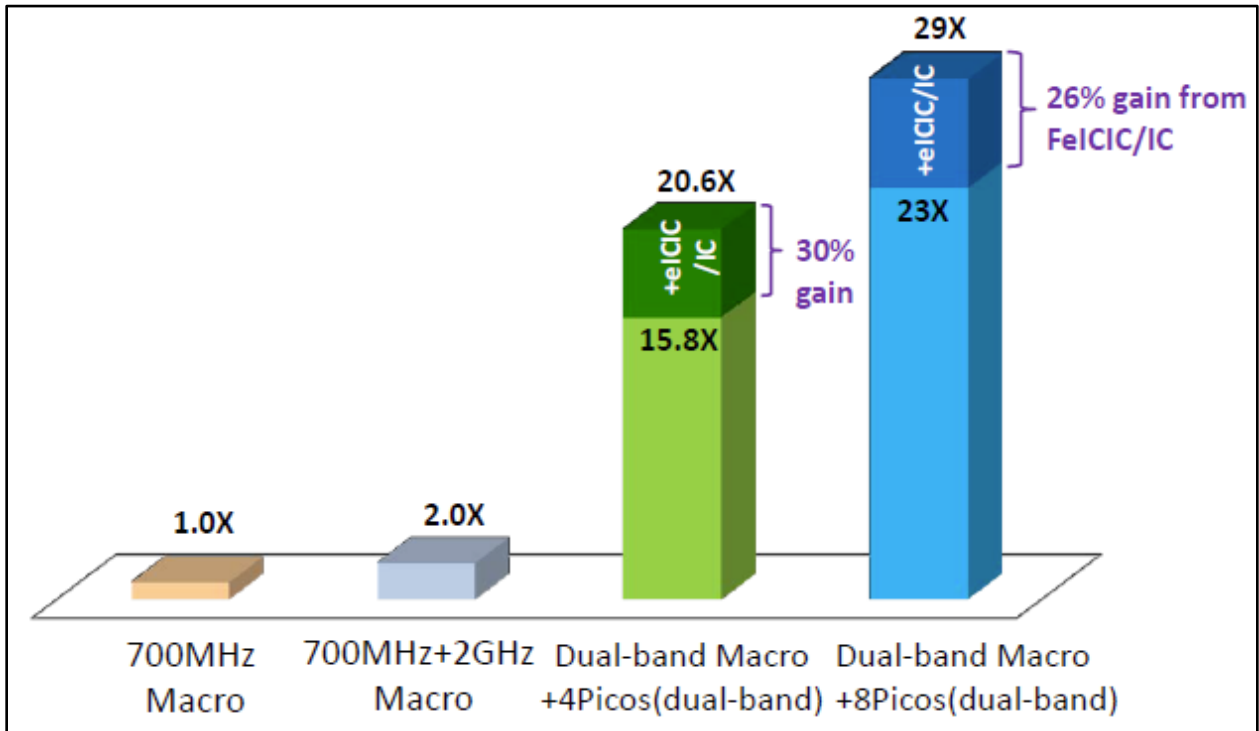

FeICIC is also beneficial in non-hotspot scenarios. In the case of a uniform distribution of picocells, this same 5G Americas member estimates a 130% gain from FeICIC for an eight picocell per macro-cell scenario, increasing capacity from a factor of 3.3 for the picocells alone to a factor of 7.6 with the addition of FeICIC.¹⁷⁹

Further insight is available from Figure 87, which shows 5 percentile and 50 percentile throughput with and without eICIC under different conditions of range extension and almost blanked subframes.

¹⁷⁸ 5G Americas member contribution. Assumes 3GPP evaluation methodology TR 36.814, carrier-aggregation UEs, macro ISD = 1732m, 700 MHz and 2GHz carrier frequency, full-buffer traffic, FDD 10+10 MHz per carrier, 6-degree antenna downtilt, 4 or 8 Picos and 30 UEs per Macro cell, hotspot distribution with 20 of 30 UEs near picos, PF scheduler, 2x2 MIMO, TU3 channel, NLOS, local partitioning algorithm.

¹⁷⁹ Assumes 3GPP evaluation methodology TR 36.814, macro ISD = 1732m, 700 MHz and 2GHz carrier frequency, full-buffer traffic, 6-degree antenna downtilt, 30 carrier-aggregation UEs per Macro cell, uniform random layout, PF scheduler, FDD, 10+10 MHz per carrier, 2x2 MIMO, TU3 channel, NLOS, local partitioning algorithm. Additional information is available at ftp://ftp.3gpp.org/tsg_ran/WG1_RL1/TSGR1_66b/Docs/R1-113383.zip.

Figure 87: User Throughput Performance With/Without eICIC for Dynamic Traffic vs. Average Offered Load per Macro Cell Area¹⁸⁰

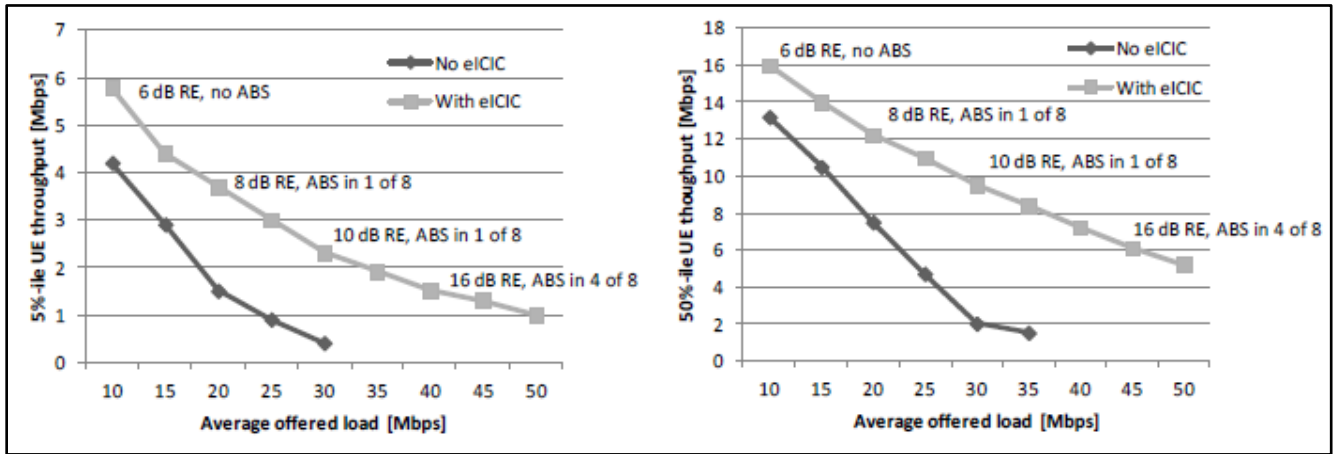

The muting of certain subframes in eICIC is dynamic and depends on identifying, on a per user basis, whether an interfering cell’s signal exceeds a threshold relative to the serving cell signal. Coordinating muting among small cells can be complicated because a small cell can simultaneously be an interferer while serving a UE that is a victim of another cell. The network must therefore coordinate muting among multiple small cells.

Figure 88 below at left shows user throughput gains of time domain interference relative to network load. Throughput gains are higher at higher network loads because of more active users and the higher likelihood of interference between the small cells.

Figure 88 below at right shows the maximum muting ratio, which increases with higher network load.

¹⁸⁰ 5G Americas member contribution. Assumes 3GPP evaluation methodology TR 36.814, 500 meter ISD, 4 picos per macro-cell area, Poisson call arrival, finite payload for each call, and termination of call upon successful delivery.

Figure 88: Throughput Gain of Time-Domain Interference Coordination¹⁸¹

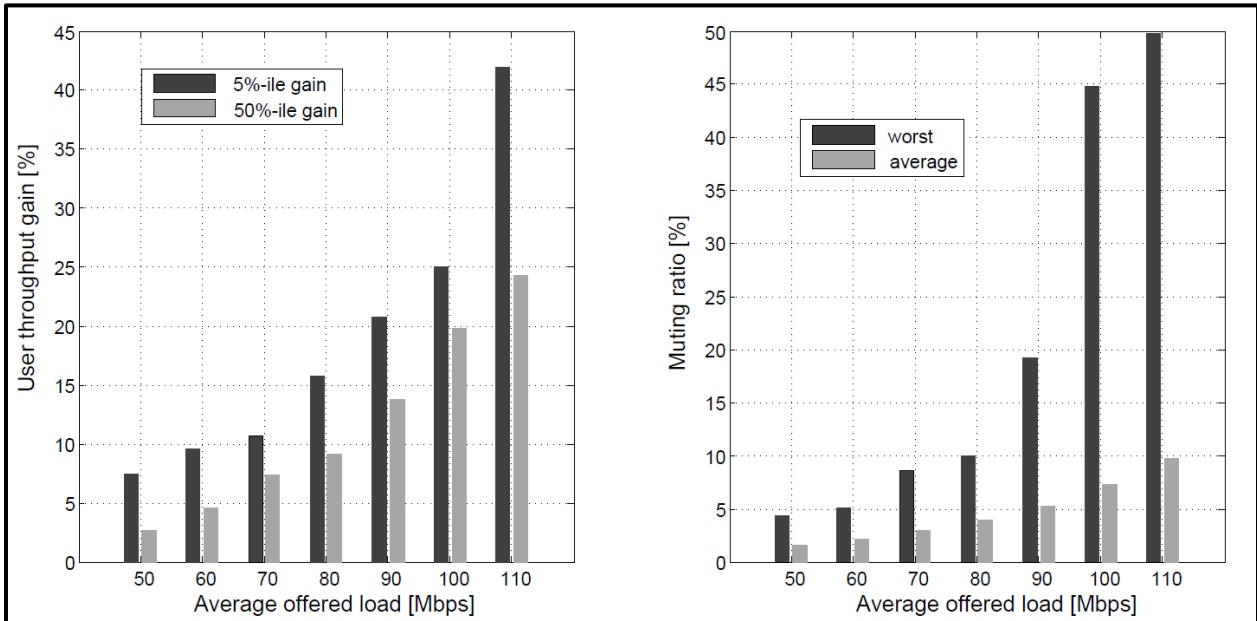

Another approach for addressing inter-layer interference cancellation in HetNets can come from carrier aggregation with no further additions or requirements and realizable with Release 10 LTE networks. Consider the scenario in Figure 89, in which both the macro eNB and the pico eNB are allocated two component carriers (namely CC1 and CC2). The idea is to create a “protected” component carrier for downlink control signals and critical information (Physical Downlink Control Channel, system information, and other control channels) while data can be conveniently scheduled on both component carriers through cross-carrier scheduling.

Figure 89: Carrier-Aggregation Based ICIC¹⁸²

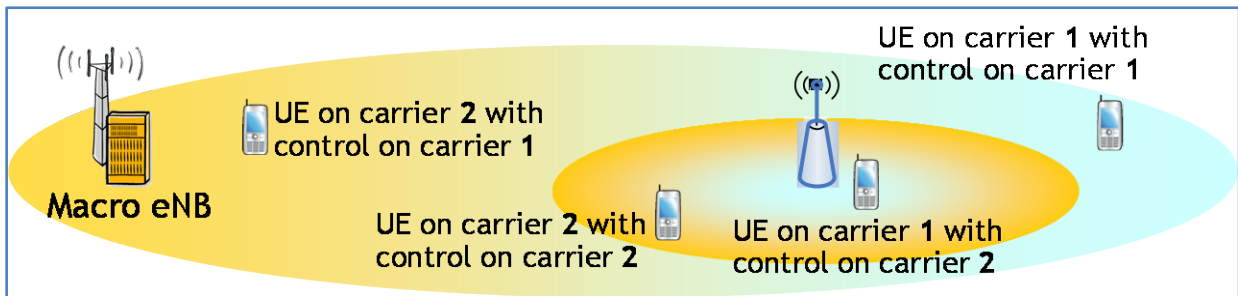

CC1 is the primary component carrier for the macro cell, while CC2 is the primary for the picocell; hence the protected carriers are CC1 for the macro cell and CC2 for the picocell. The macro cell allocates a lower transmission power for its secondary CC in order to reduce

¹⁸¹ 5G Americas member contribution. Simulations based on 12 densely deployed small cells at 3.5 GHz and 3GPP Release 12 simulation assumptions in TR 36.842.

¹⁸² 5G Americas member contribution.

interference to the picocell's primary component carrier. The network can schedule data on both the primary and secondary component carriers. In the figure, users in the cell range expansion (CRE) zone can receive data via cross-carrier scheduling from the secondary CC at subcarrier frequencies on which interference from the other cell can be reduced if the cells exchange appropriate signaling over what is called an "X2 interface." Users operating close to the eNodeBs can receive data from both component carriers as their interference levels will hopefully be lower. Therefore, a CA-capable receiver will enjoy the enhanced throughput capabilities of carrier aggregation, while simultaneously receiving extra protection for control and data channels at locations with potentially high inter-layer interference.

Thus, carrier aggregation can be a useful tool for deployment of heterogeneous networks without causing a loss of bandwidth. These solutions, however, do not scale well (in Release 10 systems) to small system bandwidths (say, 3+3 MHz or 1.4+1.4 MHz radio carriers) because control channels occupy a high percentage of total traffic. Additionally, interference between the cell reference signals (CRS) would also be significant.

Dual Connectivity

A major enhancement in Release 12 is a UE being served at the same time by both a macro cell and a small cell operating at different carrier frequencies, a capability called dual connectivity and illustrated in Figure 90. Data first reaches the macro eNodeB and is split, with part of it transmitted from the macro and the balance sent via an X2 interface to the small cell for transmission to the UE.

Figure 90: Dual Connectivity¹⁸³

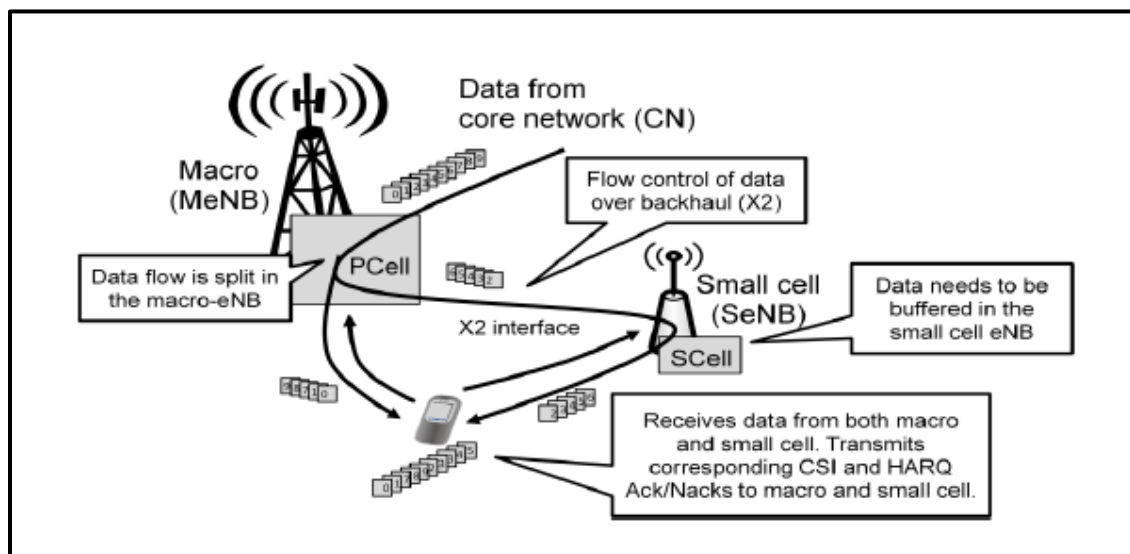
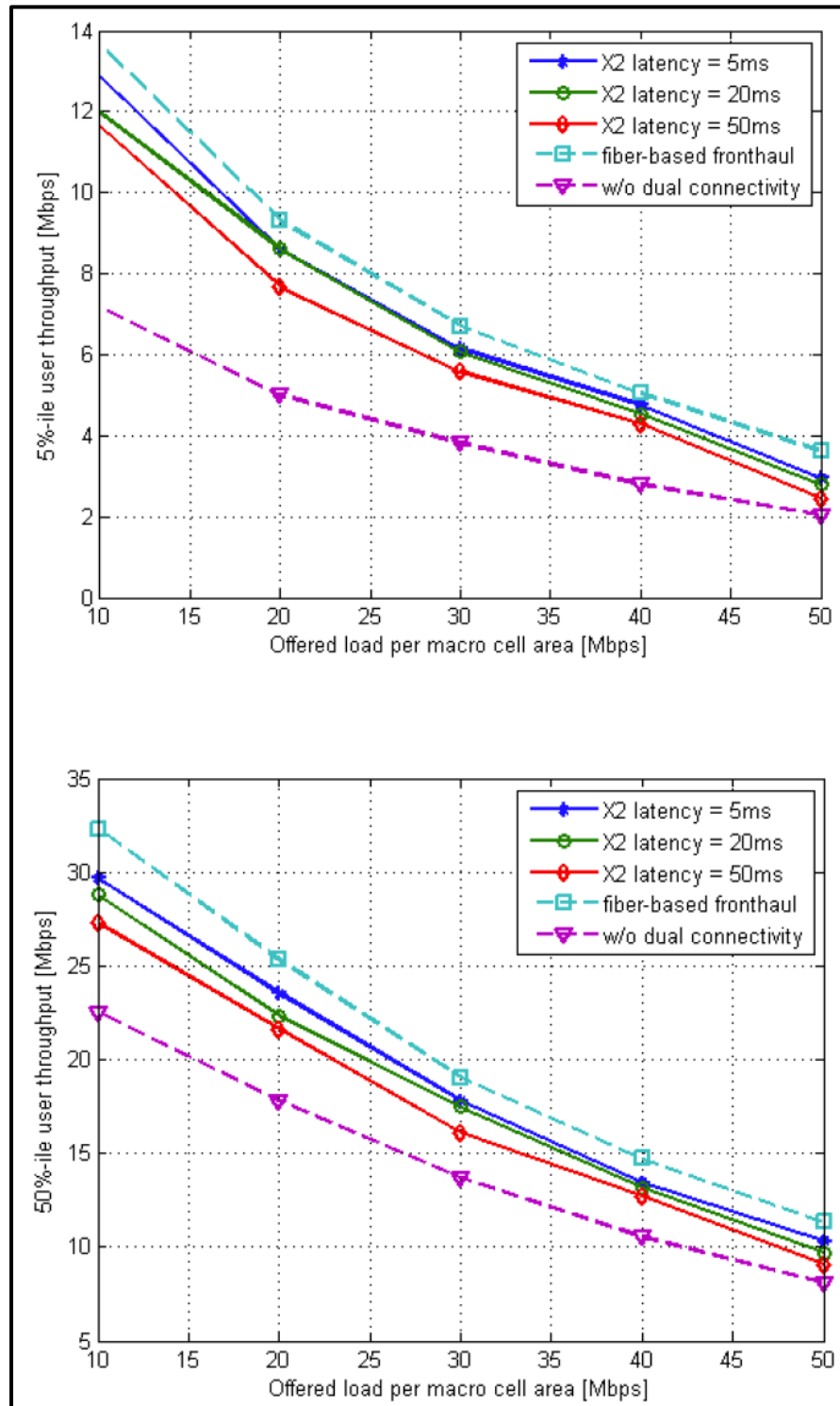

Figure 91 shows throughput gains of dual connectivity at 5 percentile and 50 percentile (median) levels relative to the load on the network and different degrees of latency in the X2 interface. Benefits are higher with lower network load and with lower X2 latency.

¹⁸³ Source: 5G Americas member contribution.

Figure 91: Dual Connectivity User Throughput¹⁸⁴



¹⁸⁴ 5G Americas member contribution.

Internet of Things and Machine-to-Machine

Anticipating huge growth in machine-to-machine communications, Release 11 added a Machine Type Communications (MTC) Interworking Function and Service Capability Server. Release 12 defined a category 0 device designed to deliver low cost through a single antenna design and other simplifications.¹⁸⁵ Release 13 went even further, with a category M-1 architecture that further reduces cost, improves range, and extends battery life. Category 13 also added Narrowband-IoT capability with Category NB-1 and an IoT solution for GSM, called “EC-GSM-IoT,” that extends coverage by 20 dB. Category M-1 and NB-IoT devices could achieve battery life as high as 10 years.

Figure 92 depicts the methods used to reduce cost in a Category M device compared with a Category 4 device.

Figure 92: Means of Achieving Lower Cost in IoT Devices¹⁸⁶

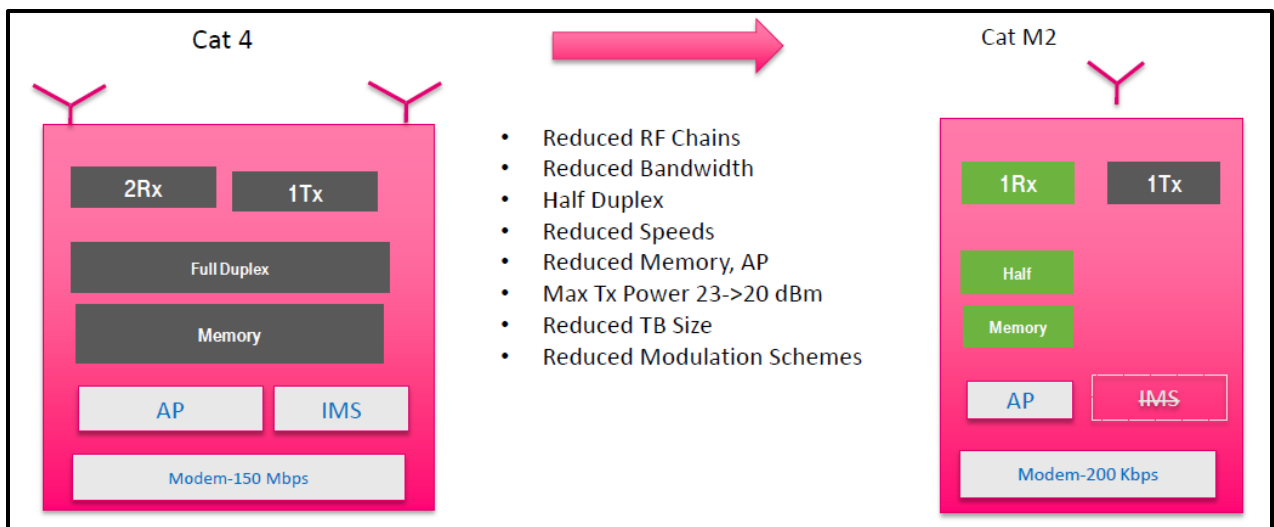

Table 26 summarizes the features of different LTE IoT devices based on 3GPP Release.

Table 26: Summary of IoT Features in LTE Devices

Device Category	Category 3	Category 1	Category 0	Category M-1	Category NB-1	EC-GSM-IoT
3GPP Release	10	11	12	13	13	13

¹⁸⁵ 3GPP, *Access System for Ultra Low Complexity and Low Throughput Internet of Things based on Cellular*, GP-140301, May 2014.

¹⁸⁶ 5G Americas member contribution.

Device Category	Category 3	Category 1	Category 0	Category M-1	Category NB-1	EC-GSM-IoT
Max. Data Rate Downlink	100 Mbps	10 Mbps	1 Mbps	1 Mbps	200 Kbps	74 Kbps
Max. Data Rate Uplink	50 Mbps	5 Mbps	1 Mbps	1 Mbps	200 Kbps	74 Kbps
Max. Bandwidth	20 MHz	20 MHz	20 MHz	1.08 MHz	0.18 MHz	0.2 MHz
Duplex	Full	Full	Optional half-duplex	Optional half-duplex	Half	Half
Max. Receive Antennas	Two	Two	One	One	One	One
Power		Power Save Mode ¹⁸⁷	Power Save Mode	Power Save Mode		
Sleep				Longer sleep cycles using Idle Discontinuous Reception (DRX)		
Coverage				Extended through redundant transmissions and Single Frequency Multicast		

Cloud Radio-Access Network (RAN) and Network Virtualization

Still in the early stages of development, cloud RAN (C-RAN) is a distributed architecture in which multiple remote radio heads connect to a “cloud” that consists of a farm of baseband processing nodes. This approach can improve centralized processing, as is needed for

¹⁸⁷ Power Save Mode specified in Release 12, but applicable to Category 1 device configured as Release 12.

CoMP, centralized scheduling, and Multiflow, without the need to exchange information among many access nodes. The performance of both LTE and HSPA technologies could be enhanced by the application of cloud RAN architectures. The term “fronthauling” has been used to describe the transport of “raw” radio signals to central processing locations, such as between the Physical Network Function (PNF) and a Virtual Network Function (VNF).

This architecture, shown in Figure 93, comes at the cost of requiring high-speed, low-latency backhaul links between these radio heads and the central controller. One vendor states that carrying 10+10 MHz of LTE with 2X2 MIMO requires 2.5 Gbps of bandwidth and imposes less than 0.1 msec of delay.¹⁸⁸ A standard called “Common Public Radio Interface” (CPRI) addresses generic formats and protocols for such a high-speed link. ETSI has also developed the Open Radio Equipment Interface (ORI). The feasibility of cloud RAN depends to a large extent on the cost and availability of fiber links between the remote radio heads and the centralized baseband processing location.

Unlike virtualizing the EPC, in which the entirety of the function can be virtualized, cloud RAN needs a PNF that terminates the RF interface. Cloud RAN therefore requires a split to be defined within the RAN. As a consequence, initial deployments of cloud RAN have looked to reuse the CPRI interface between the RRH and the baseband unit.

Figure 93: Potential Cloud RAN Approach

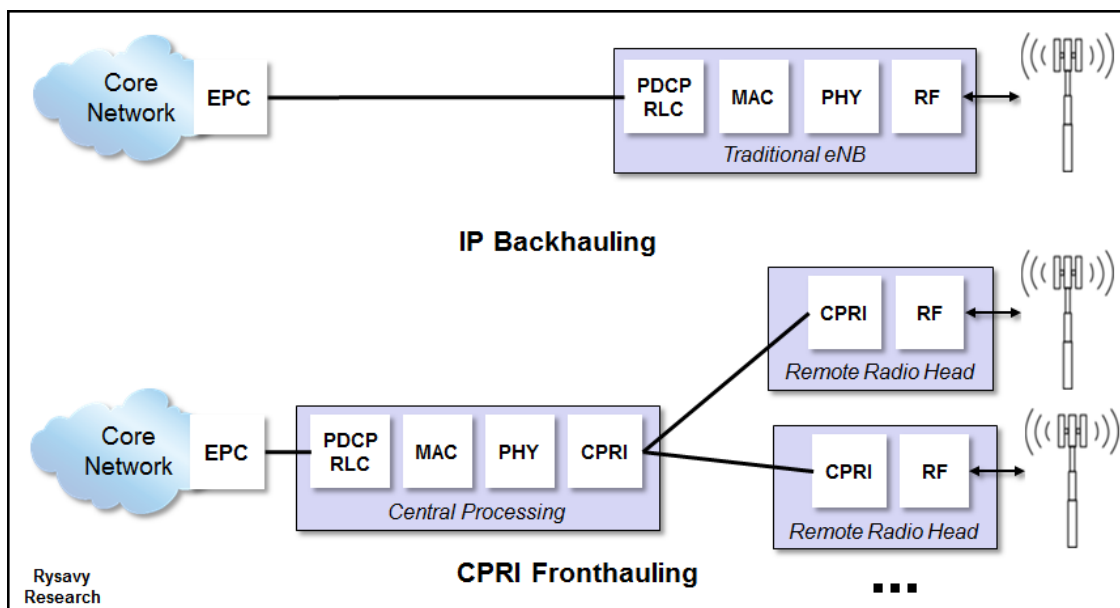

The next evolutionary step after centralizing baseband processing is to virtualize the processing by implementing the functions in software on commodity computing platforms, thus abstracting the functions from any specific hardware implementation.

C-RANs can vary by the extent of coverage, ranging from being highly localized and operating across a small number of sites to metropolitan-wide solutions. Other variables

¹⁸⁸ Dudu Bercovich, Ran Avital, “Holistic HetNet Hauling (3H),” Ceragon, February 2013. Available at http://www.ceragon.com/images/Reasource_Center/White_Papers/Ceragon_Holistic_Hetnet_Hauling_White_Paper.pdf.

include existing deployments versus greenfield situations, new LTE and 5G technologies versus integrating legacy 2G and 3G technologies, and integrating Wi-Fi. Greater scope increases complexity but yields benefits including better load-balancing and greater flexibility in spectrum re-farming.

Another design choice, as detailed in Table 27, is whether to centralize Layer 1 and Layer 2 functions (an RF-PHY split), or whether to keep Layer 1 at the base stations and centralize only Layer 2 (a PHY-MAC split).

Table 27: Partially Centralized Versus Fully Centralized C-RAN

	Fully Centralized	Partially Centralized
Transport Requirements	Multi-Gbps, usually using fiber	20 to 50 times less
Fronthaul Latency Requirement	Less than 100 microseconds	Greater than 5 milliseconds
Applications	Supports eICIC and CoMP	Supports centralized scheduling
Complexity	High	Lower
Benefit	Capacity gain	Lower capacity gain

Figure 94 analyzes the different possible RAN decompositions in greater detail.

Figure 94: Costs and Benefits of Various RAN Decompositions¹⁸⁹

	Complete Waveform Shipped to RF (IQ Samples)	Waveform Modulation/ Demod distributed	Distribute PHY and centralize MAC	Distribute time sensitive MAC (e.g., HARQ process)	Distribute Radio Link Control to reduce time sensitivity	Control Plane/Data Plane Split
No additional cost of benefit enabled	RRC PDCP RLC MAC PHY	RRC PDCP RLC MAC PHY	RRC PDCP RLC MAC	RRC PDCP RLC MAC	RRC PDCP	RRC
Cost added or challenge to providing benefit			DCP PHY RF	MAC PHY RF	RLC MAC PHY RF	PDCP RLC MAC PHY RF
Major cost added or challenge to providing benefit	RF	PHY RF				
	CPRI	Split PHY	MAC-PHY	Split MAC	PDCP-RLC	RRC-PDCP Split
Fronthaul delay requirements	100 us transport latency	<6 ms latency for interleaved HARQ	<6 ms latency for interleaved HARQ	RLC ACK Windowing latency only	Same as legacy backhaul	Same as legacy backhaul
Fronthaul bandwidth requirements	30 x BW expansion	UL BW expansion due to soft bits	Same as legacy backhaul	Same as legacy backhaul	Same as legacy backhaul	Same as legacy backhaul
Multi-vendor alignment	Limited multi-vendor ORI Support	Proprietary	Small Cell Ecosystem defining	Proprietary	Challenging	Challenging
Virtualization Support	Specialized HW required	Some functions virtualized	Some functions virtualized	Virtualized central functions	Maximal virtualization	Maximal virtualization
Performance Improvements	Inter-cell gains possible	Inter-cell gains possible	Some inter-cell gains possible	Limited inter-cells gains	Limited inter-cells gains	Some handover optimization

Although some operators in dense deployments with rich fiber assets may centralize all functions, Figure 94 uses the red rectangles to show the two most likely functional splits for LTE-Advanced and 5G:

1. **Distributed PHY and Centralized MAC.** This approach relaxes the fronthaul delay requirement to 6 msec, compared with the CPRI requirement of 250 microseconds. Fronthaul bandwidth requirement is only 10-20% greater than conventional backhaul.
2. **Control Plane/Data Plane Split.** This approach further relaxes fronthaul requirements to 30 msec and is the approach used for dual-connectivity, such as a macro and small cell simultaneously connecting to a user. For 5G, 3GPP Release 15 specifications standardize a split for cloud RAN between the PDCP and RLC layers.

¹⁸⁹ Cisco, *Cisco 5G Vision Series: Small Cell Evolution*, 2016.

Next Generation Mobile Networks studied the pros and cons of different fronthauling interfaces and published the results in March 2015.¹⁹⁰

Longer-term, perhaps in the 5G context, virtualized C-RANs may take away the very concept of cells. With methods such as beamforming and device-to-device communication, coverage may extend dynamically from a multitude of sources based on instantaneous load notifications and the radio resources available at different nodes.

In the past, RAN and core networks have been distinct entities, but over the next decade, the two may merge with more centralized, virtualized, and cloud-driven approaches.

Another form of virtualization is software-defined networking, an emerging trend in both wired and wireless networks. For cellular, SDN promises to reduce OPEX costs, simplify the introduction of new services, and improve scalability; all major infrastructure vendors are involved. The Open Networking Foundation explains that an SDN decouples the control and data planes, centralizing network state and intelligence, while abstracting the underlying network infrastructure from applications.¹⁹¹ Virtualization of network functions will be a complex, multi-year undertaking and will occur in stages, as shown in Figure 95.

¹⁹⁰ Next Generation Mobile Networks, *Further Study on Critical C-RAN Technologies, Version 1.0*, March 2015. See sections 2.2 and 2.3. Available at https://www.ngmn.org/uploads/media/NGMN_RANEV_D2_Further_Study_on_Critical_C-RAN_Technologies_v1.0.pdf.

¹⁹¹ Open Networking Foundation, "Software-Defined Networking: The New Norm for Networks," <http://www.opennetworking.org/sdn-resources/sdn-library/whitepapers>, accessed June 20, 2014.

Figure 95: Software-Defined Networking and Cloud Architectures¹⁹²

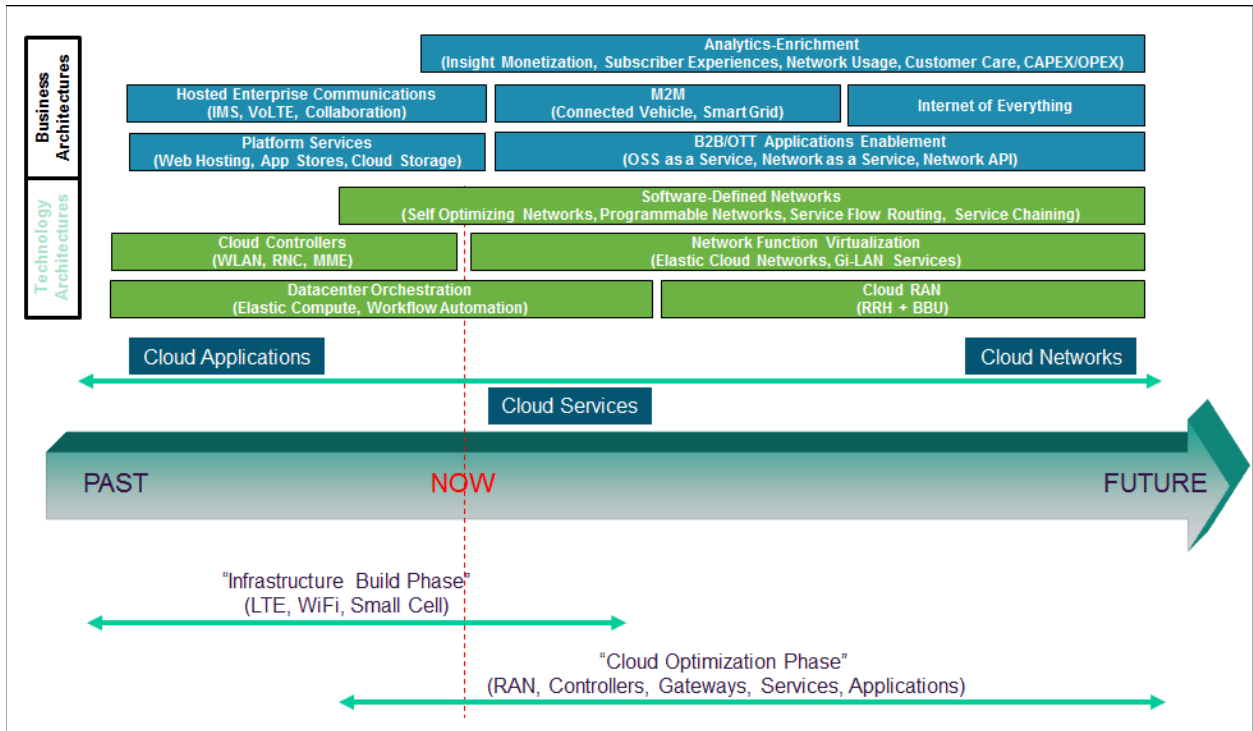

Unlicensed Spectrum Integration

See the earlier section in this report on unlicensed spectrum integration, which includes a discussion of LTE-U, LTE-LAA, MulteFire, LWA, LWIP, and RCLWI. This section covers integration approaches other than these.

3GPP has evolved its thinking on how best to integrate Wi-Fi with 3GPP networks. At the same time, the Wi-Fi Alliance and other groups have also addressed hotspot roaming, namely the ability to enable an account with one public Wi-Fi network provider to use the services of another provider that has a roaming arrangement with the first provider.

The multiple attempts to make Wi-Fi networks universally available have made for a confusing landscape of integration methods, which this section attempts to clarify. Most integration today is fairly loose, meaning that either a device communicates data via the cellular connection or via Wi-Fi. If via Wi-Fi, the connection is directly to the internet and bypasses the operator core network. In addition, any automatic handover to hotspots occurs only between the operator cellular network and operator-controlled hotspots. The goals moving forward are to:

- ❑ Support roaming relationships so that users can automatically access Wi-Fi hotspots operated by other entities.
- ❑ Enable automatic connections so that users do not have to enter usernames and passwords. In most cases, this will mean authentication based on SIM credentials.

¹⁹² 5G Americas member contribution.

- ❑ Provide secure communications on the radio link as provided by the IEEE 802.11i standard.
- ❑ Allow policy-based mechanisms that define the rules by which devices connect to various Wi-Fi networks.
- ❑ Enable simultaneous connections to both cellular and Wi-Fi, with control over which applications use which connections.
- ❑ Support different types of Wi-Fi deployments, including third-party access points and carrier access points.

Release 6 I-WLAN

3GPP Release 6 was the first release to offer the option of integrating Wi-Fi in a feature called “Interworking WLAN” (I-WLAN), using a separate IP address for each network type.

Release 8 Dual Stack Mobile IPv6 and Proxy Mobile IPv6

3GPP Release 8 specified Wi-Fi integration with the EPC using two different approaches: host-based mobility with Dual Stack Mobile IPv6 (DSMIPv6) in the client, and network based mobility with Proxy Mobile IPv6 (PMIPv6) using an intermediary node called an “Enhanced Packet Data Gateway” (ePDG).¹⁹³ This method is intended for untrusted (non-carrier-controlled) Wi-Fi networks.

Release 11 S2a-based Mobility over GTP

Release 11, however, implements a new and advantageous approach as shown in Figure 96, one that eliminates the ePDG. Called “S2a-based Mobility over GTP” (SaMOG), a trusted WLAN Access Gateway connects to multiple 3GPP-compliant access points. Traffic can route directly to the internet or traverse the packet core. This method is intended for trusted (carrier-controlled) Wi-Fi networks.

¹⁹³ 3GPP, *System Architecture Evolution (SAE); Security aspects of non-3GPP accesses*. TS 33.402.

Figure 96: Release 11 SaMOG-based Wi-Fi Integration

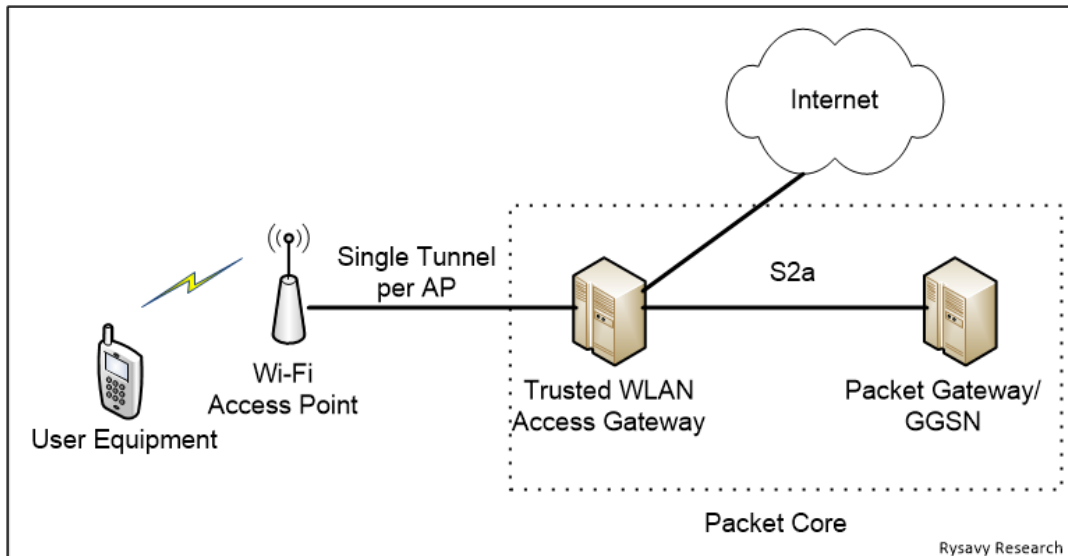

Release 12 improves SaMOG capabilities in Enhanced SaMOG (eSaMOG), in which UEs can:

- ❑ Request the connectivity type
- ❑ Indicate the Access Point Name (APN) to establish PDN connectivity
- ❑ Request to hand over an existing PDN connection
- ❑ Establish multiple PDN connections in parallel over the WLAN
- ❑ Establish a non-seamless WLAN offload connection in parallel to a Packet Data Network connection over WLAN.

Multipath TCP

A new method for potentially integrating Wi-Fi and 3GPP networks is based on work by the Internet Engineering Taskforce (IETF). Called "Multipath TCP," the approach allows a TCP connection to occur simultaneously over two different paths. The advantages of this approach include higher speeds by aggregating links and not requiring any special provisions for link-layer handovers.

The IETF has published an experimental specification, *Request for Comments 6824: CP Extensions for Multipath Operation with Multiple Addresses*, which explains this approach. The IETF is also specifying Multipath QUIC.

ANDSF

Another relevant specification is 3GPP Access Network Discovery and Selection Function (ANDSF), which provides mechanisms by which mobile devices can know where, when, and how to connect to non-3GPP access networks, such as Wi-Fi.¹⁹⁴ ANDSF operates independently of SaMOG or other ways that Wi-Fi networks might be connected.

¹⁹⁴ 3GPP, *Architecture enhancements for non-3GPP accesses, Technical Specification 23.402*.

ANDSF functionality increases with successive 3GPP versions, as summarized in Table 28.

Table 28: ANDSF Policy Management Objects and 3GPP Releases¹⁹⁵

ANDSF Policy Type	Policy Rule & Management Object	Release 8, 9	Release 10, 11	Release 12
Inter-System Mobility Policy (ISMP)	Policy, Rule priority, Prioritized Access, Validity Area (3G,4G, Wi-Fi, Geo), PLMN, Time-of-Day	X	X	X
Discovery Info	Access Network Type, Access Network Area (3G, 4G, Wi-Fi, Geo), Access Network Reference	X	X	X
UE Location	3GPP, 3GPP2, WiMAX, Wi-Fi network ID, Geo Location, PLMN	X	X	X
Inter-System Routing Policy (ISRP)	Flow Based routing, Service Based routing, Non-Seamless Offload, Roaming, PLMN, Routing Criteria, Time-of-Day, Routing rule		X	X
UE Profile	Device app/OS capability		X	X
Inter-APN Routing Policy (IARP)	Inter-APN routing over IP interface (in progress)			X
WLAN Selection Policy	Operator defined WLAN selection policy			X
Rule Selection Information	VPLMN with preferred WLAN roaming			X
Home Operator Preference	Home SP preference for S2a PDN session			X

Bidirectional Offloading Challenges

Eventually, operators will be able to closely manage user mobile broadband and Wi-Fi connections, dynamically selecting a particular network for a user based on real-time changes in loads and application requirements. Work is occurring in Release 12 to define parameters that would control switching from LTE to Wi-Fi or from Wi-Fi to LTE.¹⁹⁶

Bidirectional offloading, however, creates various challenges, as shown in Figure 97 and discussed below.

¹⁹⁵ Courtesy Smith Micro Software, 2014. <http://www.smithmicro.com>.

¹⁹⁶ 3GPP, *Study on Wireless Local Area Network (WLAN) - 3GPP radio interworking (Release 12)*, TR 37.834.

Figure 97: Bidirectional Offloading Challenges

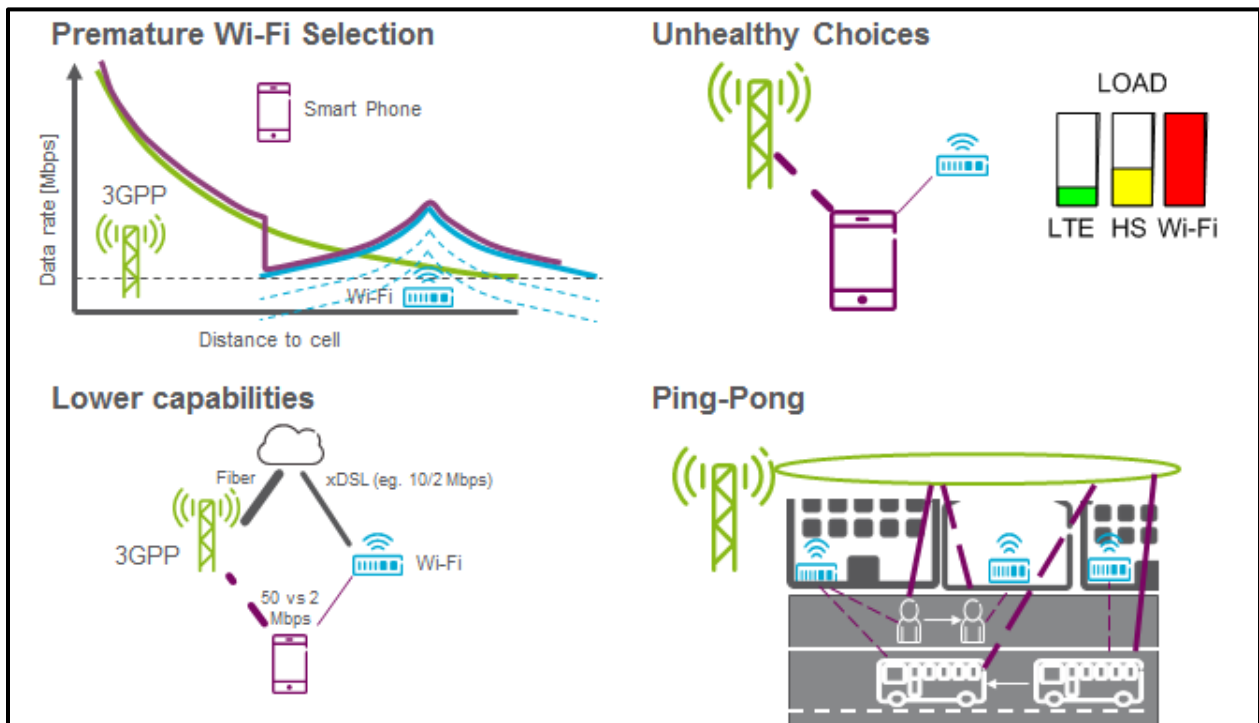

- ❑ **Premature Wi-Fi Selection.** As Wi-Fi-capable devices move into Wi-Fi coverage, they can prematurely reselect to Wi-Fi without comparative evaluation of existing cellular and incoming Wi-Fi capabilities, possibly resulting in the degradation of the end user experience. Real-time throughput-based traffic steering can mitigate this effect.
- ❑ **Unhealthy choices.** In a mixed network of LTE, HSPA, and Wi-Fi, reselection can occur due to a strong Wi-Fi network signal even though the network is under heavy load. The resulting “unhealthy” choice degrades the end user experience because the performance on the cell edge of a lightly loaded cellular network may be superior to that of the heavily loaded Wi-Fi network. Real-time load-based traffic steering can be beneficial in this scenario.
- ❑ **Lower capabilities.** In some cases, selection to a Wi-Fi network may result in reduced performance even if it offers a strong signal because of other factors, such as lower-bandwidth backhaul. Evaluation of criteria beyond wireless capabilities prior to access selection can improve this circumstance.
- ❑ **Ping-Pong.** Ping-ponging between Wi-Fi and cellular, especially if both offer similar signal strengths, can also degrade the user experience. Hysteresis approaches, similar to those used in cellular inter-radio transfer, can better manage transfer between Wi-Fi and cellular accesses.

3GPP RAN2 is discussing real-time or near-real-time methods to address the challenges discussed above.

Other Integration Technologies (SIPTO, LIPA, IFOM, MAPCON)

Release 10 defines additional options for Wi-Fi integration, including Selected IP Traffic Offload (SIPTO), Local IP Access (LIPA), Multi-Access PDN Connectivity (MAPCON), and IP Flow and Seamless Offload (IFOM).

SIPTO is mostly a mechanism to offload traffic that does not need to flow through the core, such as internet-destined traffic. SIPTO can operate on a home femtocell, or it can operate in the macro network.

Local IP Access (LIPA) provides access to local networks, useful with femtocells that normally route all traffic back to the operator network. With LIPA, the UE in a home environment can access local printers, scanners, file servers, media servers, and other resources.

IFOM, as shown in Figure 98, enables simultaneous cellular and Wi-Fi connections, with different traffic flowing over the different connections. A Netflix movie could stream over Wi-Fi, while a VoIP call might flow over the cellular-data connection. IFOM requires the UE to implement Dual Stack Mobile IPv6 (DSMIPv6).

Figure 98: 3GPP IP Flow and Seamless Mobility

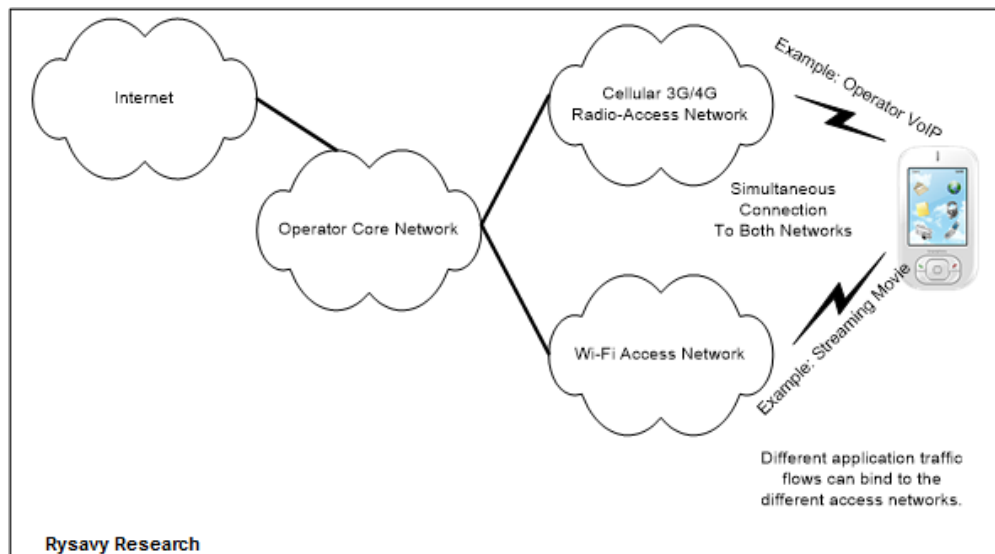

Similar to IFOM, Release 10 feature MAPCON allows multiple simultaneous PDN connections (each with a separate APN), such as Wi-Fi and 3GPP radio access. The UE uses separate IP addresses for each connection but does not need Dual Stack Mobile IPv6 (DSMIPv6).

Hotspot 2.0

Developed by the Wi-Fi Alliance, Hotspot 2.0 specifications, also called "Next Generation Hotspot," facilitate Wi-Fi roaming. Using the IEEE 802.11u standard that allows devices to determine what services are available from an access point, Hotspot 2.0 simplifies the process by which users connect to hotspots, automatically identifying roaming partnerships

and simplifying authentication and connections, as shown in Figure 99.¹⁹⁷ It also provides for encrypted communications over the radio link.¹⁹⁸

Figure 99: Roaming Using Hotspot 2.0

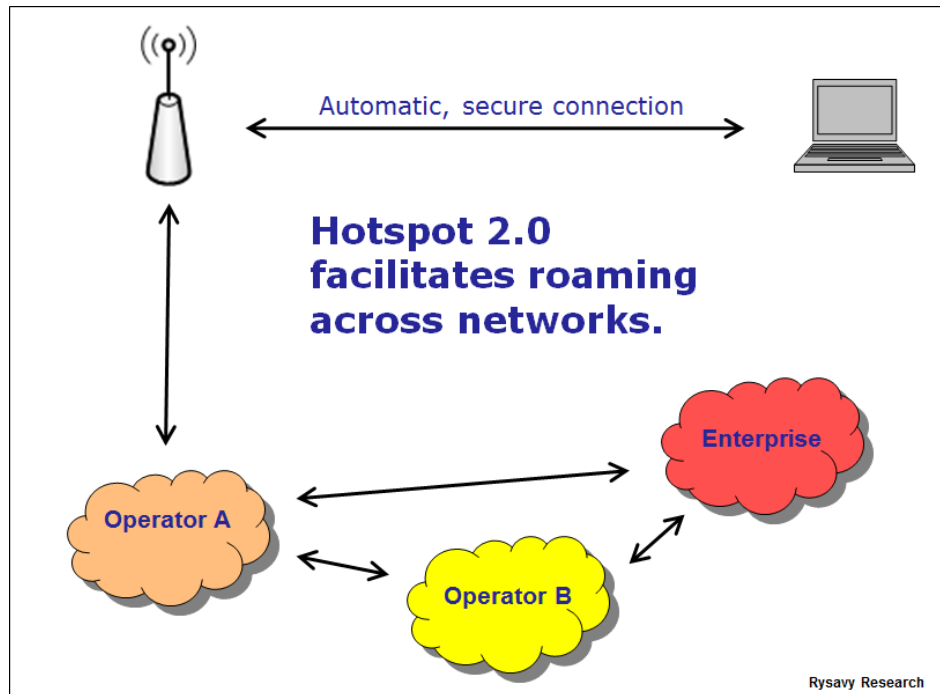

Using IEEE 802.11u, devices can determine what roaming relationships an access point supports and can then securely connect to the Wi-Fi network using one of these roaming arrangements, as shown in Figure 100. Hotspot 2.0 authentication is based on the Extended Authentication Protocol (EAP) using SIM credentials. There are plans to enhance the Hotspot 2.0 protocols in Phase 2, which will define online signup to enable non-SIM-based devices to easily and securely register for services. The Wi-Fi Alliance began a Hotspot 2.0 certification process for devices and access points in June 2012 and uses the designation “Wi-Fi Certified Passpoint” for compliant devices.

¹⁹⁷ For example, user devices can be authenticated based on their SIM credentials. Or, users can register or click through an agreement and then not need to redo that with future associations.

¹⁹⁸ The IEEE 802.11i standard has provided encryption for 802.11 communications for many years; however, most hotspots have not implemented this encryption, whereas Hotspot 2.0 does.

Figure 100: Hotspot 2.0 Connection Procedure

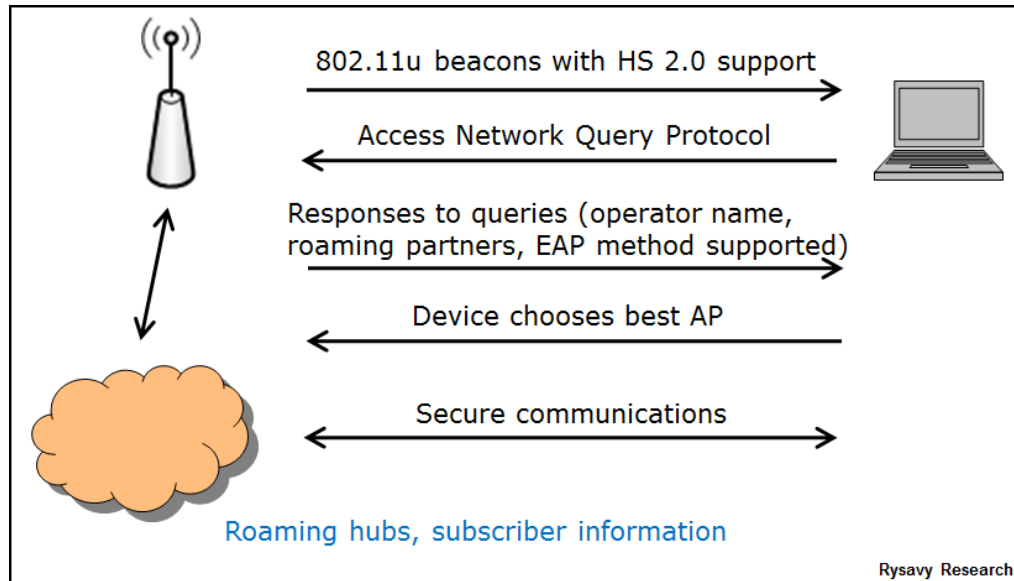

Release 2 of Passpoint, available in 2014, added immediate account provisioning, which facilitates a user establishing an account at the point of access. The new version also provides for policies to be downloaded from the network operator; these policies control network selection priorities when multiple networks are available.

Self-Organizing Networks (SON)

As the number of base stations increase through denser deployments and through deployment of femtocells and picocells, manual configuration and maintenance of this infrastructure becomes impractical. With SON, base stations organize and configure themselves by communicating with one another and with the core network. SONs can also self-heal in failure situations.

3GPP began standardization of self-optimization and self-organization in Releases 8 and 9, a key goal being support of multi-vendor environments. Successive releases have augmented SON capabilities.

Features being defined in SON include:

- ❑ Automatic inventory;
- ❑ Automatic software download;
- ❑ Automatic neighbor relation;
- ❑ Automatic physical Cell ID assignment;
- ❑ Mobility robustness/handover optimization;
- ❑ Random access channel optimization;
- ❑ Load-balancing optimization;
- ❑ Inter-cell interference coordination (ICIC) management;

- ❑ Enhanced inter-cell interference coordination (eICIC) management;
- ❑ Coverage and capacity optimization;
- ❑ Cell outage detection and compensation;
- ❑ Self-healing functions;
- ❑ Minimization of drive testing;
- ❑ Energy savings; and
- ❑ Coordination among various SON functions.

3GPP categorizes SON as centralized, distributed, or hybrid, which is a combination of centralized and distributed approaches.

In a centralized architecture, SON algorithms operate on a central network management system or central SON server. In contrast, in a distributed approach, the SON algorithms operate at the eNBs, which make autonomous decisions based on local measurements as well as from other nearby eNBs received via an X2 interface that interconnects eNBs.

The distributed architecture permits faster and easier deployment but is not necessarily as efficient or as consistent in operation, especially in multi-vendor infrastructure deployments.

In a hybrid approach, shown in Figure 101, SON algorithms operate both at the eNB and at a central SON server, with the server supplying values of initial parameters, for example. The eNBs may then update and refine those parameters in response to local measurements.

The hybrid approach resolves deployment scenarios that cannot be resolved by dSON, for example, cases such as:

- ❑ No X2 interface between the eNBs.
- ❑ Multi-vendor deployment with different dSON algorithms.
- ❑ Multi-technology load balancing and user steering.

Figure 101: Hybrid SON Architecture¹⁹⁹

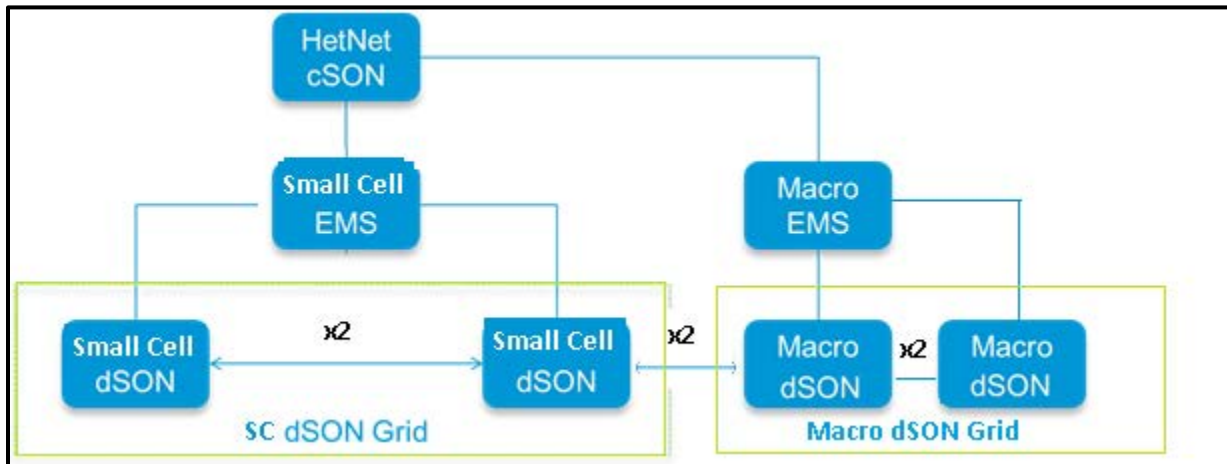

With increasing numbers of macro cells and small cells, interference opportunities increase as well. Optimizing power settings through intelligent power management algorithms is crucial for maximum efficiency with the least amount of interference, including pilot pollution. Pilot pollution can result in low data rates and ping-pong handovers due to channel fading. A hybrid SON approach is well suited for optimized power management.

IP Multimedia Subsystem (IMS)

IP Multimedia Subsystem (IMS) is a service platform for IP multimedia applications: video sharing, PoC, VoIP, streaming video, interactive gaming, and others. IMS by itself does not provide all these applications. Rather, it provides a framework of application servers, subscriber databases, and gateways to make them possible. The exact services will depend on cellular operators and the application developers that make these applications available to operators. The primary application in 2016, however, is VoLTE.

The core networking protocol used within IMS is Session Initiation Protocol (SIP), which includes the companion Session Description Protocol (SDP) used to convey configuration information such as supported voice codecs. Other protocols include Real Time Transport Protocol (RTP) and Real Time Streaming Protocol (RTSP) for transporting actual sessions. The QoS mechanisms in UMTS will be an important component of some IMS applications.

Although originally specified by 3GPP, numerous other organizations around the world are supporting IMS. These include the IETF, which specifies key protocols such as SIP, and the Open Mobile Alliance, which specifies end-to-end, service-layer applications. Other organizations supporting IMS include the GSMA, ETSI, CableLabs, 3GPP2, The Parlay Group, the ITU, ANSI, the Telecoms and Internet Converged Services and Protocols for Advanced Networks (TISPAN), and the Java Community Process (JCP).

IMS is relatively independent of the radio-access network and can, and likely will, be used by other radio-access networks or wireline networks. Other applications include picture and video sharing that occur in parallel with voice communications. Operators looking to roll out VoIP over networks will use IMS. For example, VoLTE depends on IMS infrastructure.

¹⁹⁹ 5G Americas member contribution.

3GPP initially introduced IMS in Release 5 and has enhanced it in each subsequent specification release.

As shown in Figure 102, IMS operates just outside the packet core.

Figure 102: IP Multimedia Subsystem

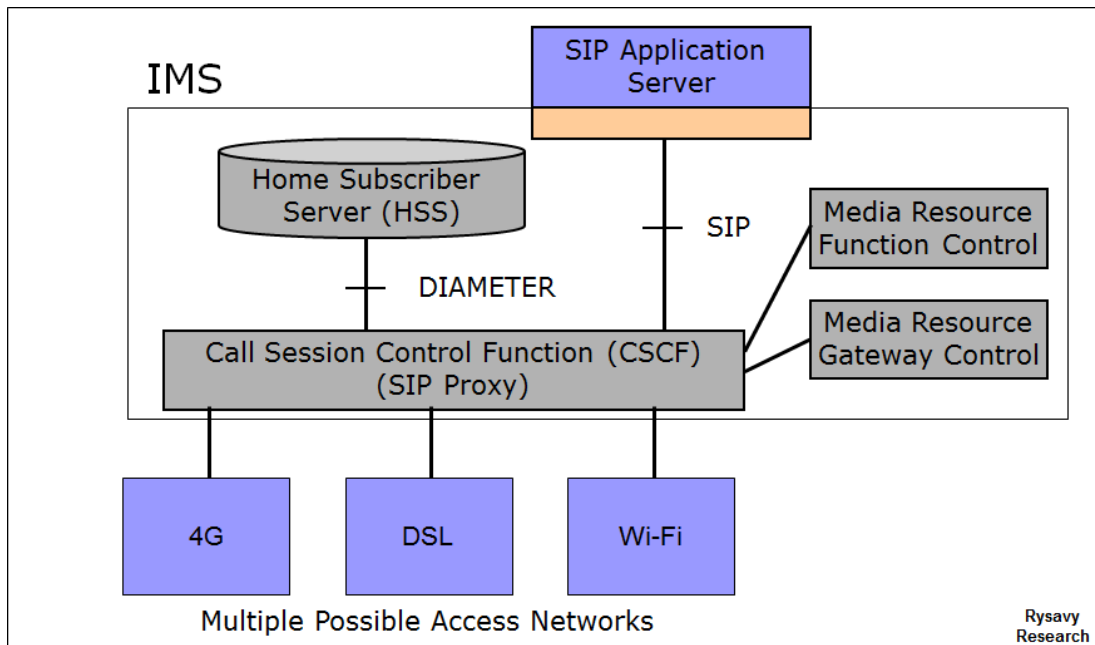

The benefits of using IMS include handling all communication in the packet domain, tighter integration with the internet, and a lower cost infrastructure based on IP building blocks for both voice and data services.

IMS applications can reside either in the operator's network or in third-party networks including those of enterprises. By managing services and applications centrally—and independently of the access network—IMS can enable network convergence. This allows operators to offer common services across 3G, Wi-Fi, and wireline networks.

Service Continuity, defined in Release 8, provided for a user's entire session to continue seamlessly as the user moves from one access network to another. Release 9 expanded this concept to allow sessions to move across different device types. For example, the user could transfer a video call in midsession from a mobile phone to a large-screen TV, assuming both have an IMS appearance in the network.

Release 8 introduced the IMS Centralized Services (ICS) feature, which allows for IMS-controlled voice features to use either packet-switched or circuit-switched access.

Given that LTE operators will integrate their 5G networks with their current LTE networks, operators are likely to keep using IMS in conjunction with LTE for their voice and other services that use IMS, even as they begin deploying 5G.

Broadcast/Multicast Services

An important capability for 3G and evolved 3G systems is broadcasting and multicasting, wherein multiple users receive the same information using the same radio resource. This

creates a more efficient approach to deliver video when multiple users desire the same content simultaneously. In a broadcast, every subscriber unit in a service area receives the information, whereas in a multicast, only users with subscriptions receive the information. Service areas for both broadcast and multicast can span either the entire network or a specific geographical area. Potential applications include sporting events, select news, venue-specific (shopping mall, museum) information, and even delivery of software upgrades. Giving users the ability to store and replay select content could further expand the scope of applications.

3GPP defined highly efficient broadcast/multicast capabilities for UMTS in Release 6 with MBMS. Release 7 defined optimizations through a feature called multicast/broadcast, single-frequency network operation that involves simultaneous transmission of the exact waveform across multiple cells. This enables the receiver to constructively superpose multiple MBMS Single Frequency Network (SFN), or MBSFN, cell transmissions. The result is highly efficient, WCDMA-based broadcast transmission technology that matches the benefits of OFDMA-based broadcast approaches.

LTE also has a broadcast/multicast capability called eMBMS. OFDM is particularly well suited for efficient broadcasting, as shown in Figure 103, because the mobile system can combine the signal from multiple base stations, also an MBSFN approach, and because of the narrowband nature of OFDM. Normally, these signals would interfere with one another. The single frequency network is a cluster of cells that transmit the same content synchronously with a common carrier frequency.

Figure 103: OFDM Enables Efficient Broadcasting

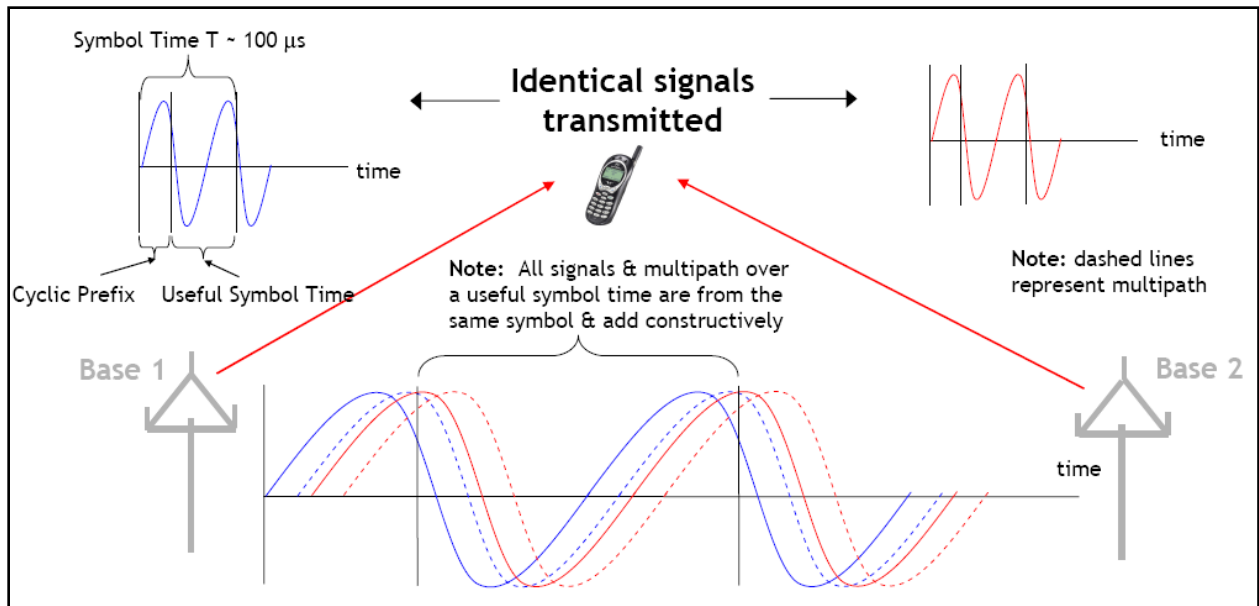

Despite various broadcast technologies being available, market adoption to date has been relatively slow. Internet trends have favored unicast approaches, with users viewing videos of their selection on demand, but there is increasing interest in using eMBMS with LTE to alleviate capacity demands.

Backhaul

Connecting sites to core networks remains a challenge, whether for small cells or macro cells, especially as networks need to deliver higher bandwidth. Fiber is the gold standard, but it is not available everywhere and can be expensive, so operators use a combination of wired and wireless links.

Today's backhaul requirements for LTE can range from 1 to 10 Gbps. By 2020, backhaul requirements could exceed 10 Gbps.²⁰⁰

Table 29 and Table 30 summarize the methods and capabilities of the various available approaches.

Table 29: Wired Backhaul Methods and Capabilities²⁰¹

Technology	Distance	Throughput Speed
Direct Fiber	80 km	Hundreds of Mbps to Gbps
Bonded VDSL2	To 5,000 feet	75 Mbps down, 12 Mbps up
FTTX	Most urban areas	Up to 2.5 Gbps down, 1.5 Gbps up
DOCSIS	Most urban areas	Up to 285 Mbps down, 105 Mbps up

Table 30: Wireless Backhaul Methods and Capabilities²⁰²

Technology	Distance	Line-of-Sight	Throughput Speed
5G Integrated Access and Backhaul	1 km	Yes	1 to 10 Gbps
Millimeter Wave (60 GHz)	1 km	Yes	1 Gbps
Millimeter Wave (70-80 GHz)	3 km (with speed tradeoff)	Yes	10 Gbps
Microwave (6-60 GHz)	Varies by frequency: 2-4 km typical at 30-42 GHz	Yes	1 Gbps+

²⁰⁰ Arthur D. Little, *Creating a Gigabit Society – The Rule of 5G; A report by Arthur D. Little for Vodafone Group*, 2017. See Figure 6.

²⁰¹ Small Cell Forum, "Backhaul Technologies for Small Cells," February 2013.

²⁰² Ibid.

Technology	Distance	Line-of-Sight	Throughput Speed
Licensed sub 6 GHz	1.5 to 10 km	No	170 Mbps (20 MHz TDD), 400 Mbps+ with new technology
Unlicensed sub-6 GHz	Up to 250 meters	No	450 Mbps (IEEE 802.11n 3X3 MIMO)
TV White Space (802.11af-based)	1 to 5 km max throughput, 10 km+ possible	Depends on deployment model	80 Mbps in 6 MHz TDD with 4X4 MIMO
Satellite	Available everywhere	Yes	Up to 50 Mbps downlink, 15 Mbps uplink

UMTS-HSPA

UMTS technology is mature and benefits from research and development that began in the early 1990s. It has been thoroughly trialed, tested, and commercially deployed. UMTS employs a wideband CDMA radio-access technology. The primary benefits of UMTS include high spectral efficiency for voice and data, simultaneous voice and data capability, high user densities that can be supported with low infrastructure costs, and support for high-bandwidth data applications. Operators can also use their entire available spectrum for both voice and high-speed data services.

Additionally, operators can use a common core network, called the UMTS multi-radio network as shown in Figure 104, which supports multiple radio-access networks including GSM, EDGE, WCDMA, HSPA, and evolutions of these technologies.

Figure 104: UMTS Multi-radio Network

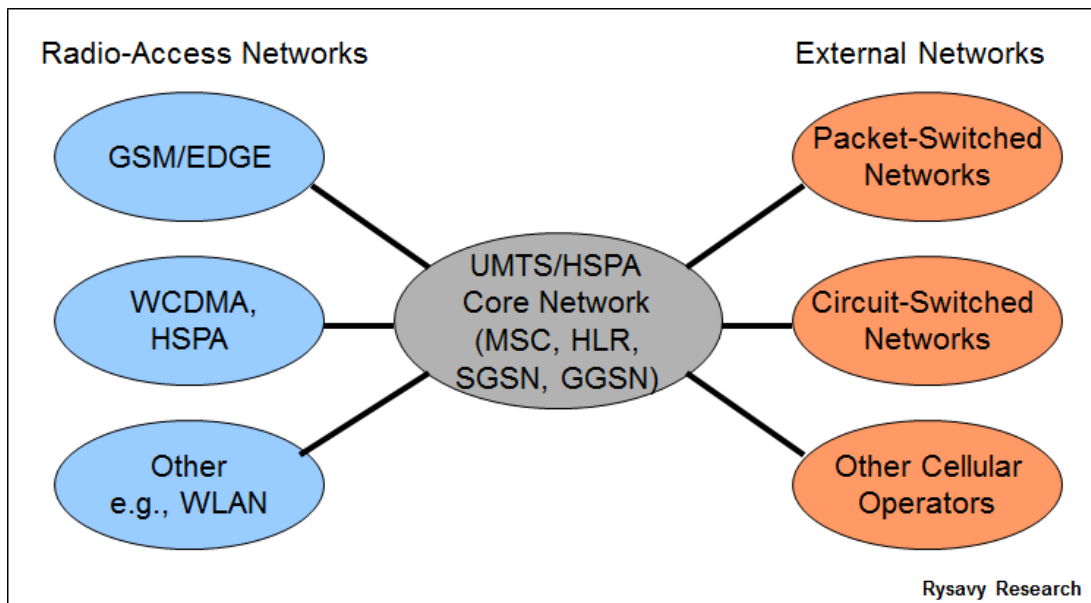

HSPA refers to networks that support both HSDPA and HSUPA. All new deployments today are HSPA, and many operators have upgraded their HSDPA networks to HSPA. For example, in 2008, AT&T upgraded most of its network to HSPA. By the end of 2008, HSPA was deployed throughout the Americas.

The UMTS radio-access network consists of base stations referred to as Node B (corresponding to GSM base transceiver systems) that connect to RNCs (corresponding to GSM base station controllers [BSCs]). The RNCs connect to the core network as do the BSCs. When both GSM and WCDMA access networks are available, the network can hand users over between these networks. This is important for managing capacity, as well as in areas in which the operator has continuous GSM coverage, but has only deployed WCDMA in some locations.

Whereas GSM can effectively operate like a spread-spectrum system²⁰³, based on time division in combination with frequency hopping, WCDMA is a direct-sequence, spread-spectrum system. WCDMA is spectrally more efficient than GSM, but it is the wideband nature of WCDMA that provides its greatest advantage—the ability to translate the available spectrum into high data rates. This wideband technology approach results in the flexibility to manage multiple traffic types including voice, narrowband data, and wideband data.

HSDPA

HSDPA, specified in 3GPP Release 5, saw the introduction of high-performance, packet data service that delivers peak theoretical rates of 14 Mbps. Peak user-achievable throughput rates in initial deployments are well over 1 Mbps and as high as 4 Mbps in some networks. The same radio carrier can simultaneously service UMTS voice and data users, as well as HSDPA data users.

HSDPA achieves its high speeds through techniques similar to those that push EDGE performance past GPRS including higher order modulation, variable coding, and soft combining, as well as through the addition of fast scheduling and other techniques.

HSDPA achieves its performance gains from the following radio features:

- ❑ High-speed channels shared in both code and time domains
- ❑ Short TTI
- ❑ Fast scheduling and user diversity
- ❑ Higher order modulation
- ❑ Fast link adaptation
- ❑ Fast HARQ

These features function as follows:

High-Speed Shared Channels and Short Transmission Time Interval: First, HSDPA uses high-speed data channels called “High Speed Physical Downlink Shared Channels” (HS-PDSCH). Up to 15 of these channels can operate in the 5 MHz WCDMA radio channel. Each uses a fixed spreading factor of 16. User transmissions are assigned to one or more of these channels for a short TTI of 2 msec. The network can then readjust how users are assigned to different HS-PDSCH every 2 msec. Resources are thus assigned in both time

²⁰³ Spread spectrum systems can either be direct sequence or frequency hopping.

(the TTI interval) and code domains (the HS-PDSCH channels). Figure 105 illustrates different users obtaining different radio resources.

Figure 105: High Speed–Downlink Shared Channels (Example)

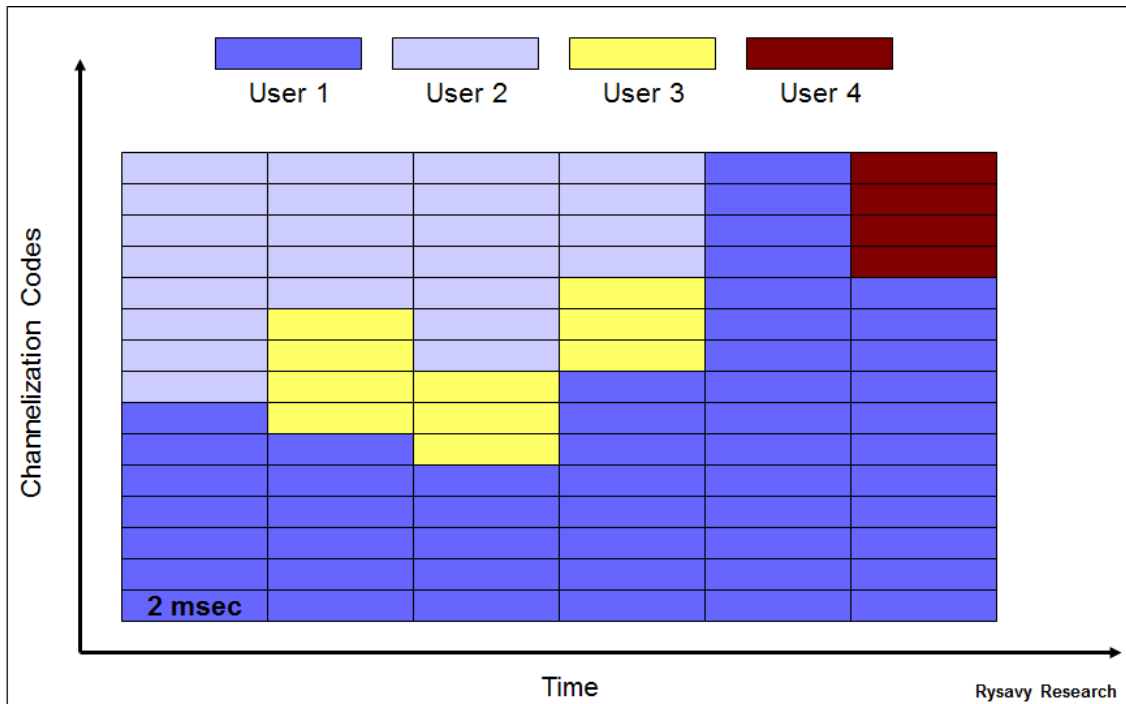

Fast Scheduling and User Diversity: Fast scheduling exploits the short TTI by assigning users channels that have the best instantaneous channel conditions, rather than in a round-robin fashion. Because channel conditions vary somewhat randomly across users, most users can be serviced with optimum radio conditions and thereby obtain optimum data throughput. Figure 106 shows how a scheduler might choose between two users based on their varying radio conditions to emphasize the user with better instantaneous signal quality. With about 30 users active in a sector, the network achieves significant user diversity and much higher spectral efficiency. The system also ensures that each user receives a minimum level of throughput, an approach called proportional fair scheduling.

Figure 106: User Diversity

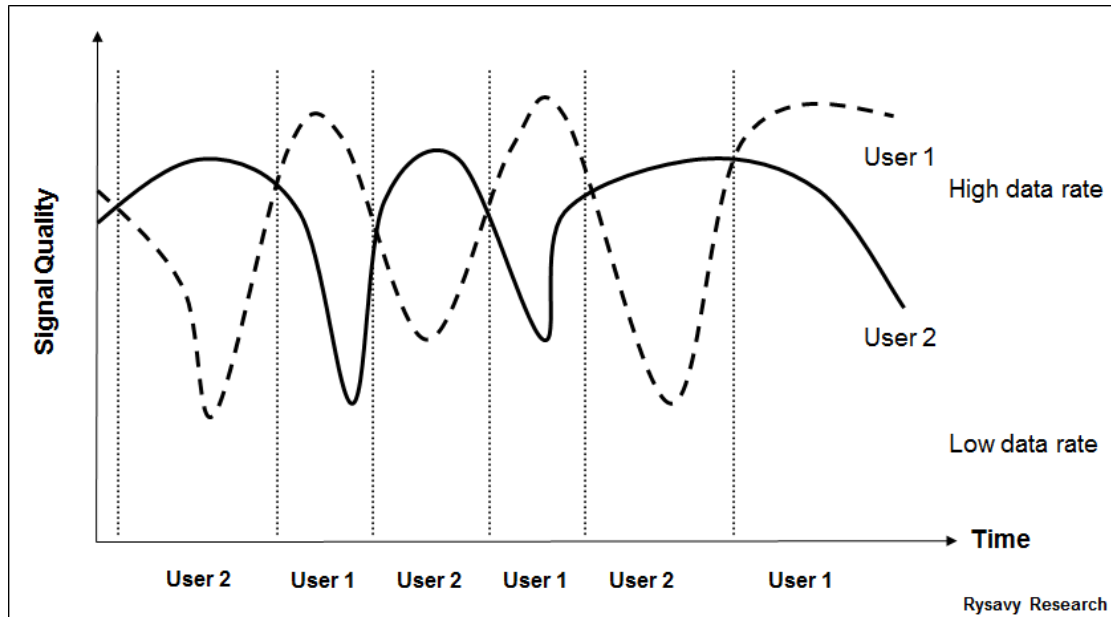

Higher Order Modulation: HSDPA uses both the modulation used in WCDMA—namely QPSK—and, under good radio conditions, an advanced modulation scheme—16 QAM. 16 QAM transmits 4 bits of data in each radio symbol compared to 2 bits with QPSK. Data throughput is increased with 16 QAM, while QPSK is available for adverse radio conditions. HSPA Evolution adds 64 QAM modulation to further increase throughput rates. 64 QAM became available in Release 7, and the combination of MIMO and 64 QAM became available in Release 8.

Fast Link Adaptation: Depending on the condition of the radio channel, different levels of forward-error correction (channel coding) can also be employed. For example, a three-quarter coding rate means that three quarters of the bits transmitted are user bits, and one quarter are error-correcting bits. Fast link adaptation refers to the process of selecting and quickly updating the optimum modulation and coding rate and occurs in coordination with fast scheduling.

Fast Hybrid Automatic Repeat Request: Another HSDPA technique is Fast Hybrid Automatic Repeat Request (Fast Hybrid ARQ). “Fast” refers to the medium-access control mechanisms implemented in Node B (along with scheduling and link adaptation), as opposed to the BSC in GPRS/EDGE, and “hybrid” refers to a process of combining repeated data transmissions with prior transmissions to increase the likelihood of successful decoding. Managing and responding to real-time radio variations at the base station, as opposed to an internal network node, reduces delays and further improves overall data throughput.

Using the approaches just described, HSDPA maximizes data throughputs and capacity and minimizes delays. For users, this translates to better network performance under loaded conditions, faster application performance, and a greater range of applications that function well.

Field results validate the theoretical throughput results. With initial 1.8 Mbps peak rate devices, vendors measured consistent throughput rates in actual deployments of more than 1 Mbps. These rates rose to more than 2 Mbps for 3.6 Mbps devices and then close to 4 Mbps for 7.2 Mbps devices.

In 2008, typical devices supporting peak data rates of 3.6 Mbps or 7.2 Mbps became available. Many operator networks support 7.2 Mbps peak operation, and some even support the maximum rate of 14.4 Mbps.

HSUPA

Whereas HSDPA optimizes downlink performance, HSUPA—which uses the Enhanced Dedicated Channel (E-DCH)—constitutes a set of improvements that optimizes uplink performance. Networks and devices supporting HSUPA became available in 2007. These improvements include higher throughputs, reduced latency, and increased spectral efficiency. HSUPA was standardized in Release 6. It results in an approximately 85% increase in overall cell throughput on the uplink and more than a 50% gain in user throughput. HSUPA also reduces packet delays, a significant benefit resulting in much improved application performance on HSPA networks

Although the primary downlink traffic channel supporting HSDPA serves as a shared channel designed for the support of services delivered through the packet-switched domain, the primary uplink traffic channel defined for HSUPA is a dedicated channel that could be used for services delivered through either the circuit-switched or the packet-switched domains. Nevertheless, by extension and for simplicity, the WCDMA-enhanced uplink capabilities are often identified in the literature as HSUPA.

HSUPA achieves its performance gains through the following approaches:

- ❑ An enhanced dedicated physical channel.
- ❑ A short TTI, as low as 2 msec, which allows faster responses to changing radio conditions and error conditions.
- ❑ Fast Node B-based scheduling, which allows the base station to efficiently allocate radio resources.
- ❑ Fast Hybrid ARQ, which improves the efficiency of error processing.

The combination of TTI, fast scheduling, and Fast Hybrid ARQ also serves to reduce latency. HSUPA can operate with or without HSDPA in the downlink, although use the two approaches together. The improved uplink mechanisms also translate to better coverage and, for rural deployments, larger cell sizes.

HSUPA can achieve different throughput rates based on various parameters including the number of codes used, the spreading factor of the codes, the TTI value, and the transport block size in bytes.

Initial devices enabled peak user rates of close to 2 Mbps as measured in actual network deployments, while current devices have throughputs of more than 5 Mbps. Future devices could have network rates as high as 69 Mbps, as discussed further below.

Beyond throughput enhancements, HSUPA also significantly reduces latency.

Evolution of HSPA (HSPA+)

The goal in evolving HSPA is to exploit available radio technologies—largely enabled by increases in digital signal processing power—to maximize CDMA-based radio performance. This evolution has significantly advanced HSPA and extends the life of sizeable operator infrastructure investments.

Wireless and networking technologists have defined a series of enhancements for HSPA, beginning in Release 7 and now continuing through Release 14. These include advanced receivers, multi-carrier operation, MIMO, Continuous Packet Connectivity, Higher-Order Modulation, One-Tunnel Architecture, HetNet support, and advanced voice capabilities both in circuit- and packet-switched domains.

Taking advantage of these various radio technologies, 3GPP has standardized a number of features, beginning in Release 7 including higher order modulation and MIMO. Collectively, these capabilities are referred to as HSPA+. Release 8 through Release 12 include further enhancements.

The goals of HSPA+ were to:

- ❑ Exploit the full potential of a CDMA approach.
- ❑ Provide smooth interworking between HSPA+ and LTE, thereby facilitating the operation of both technologies. As such, operators may choose to leverage the EPC planned for LTE.
- ❑ Allow operation in a packet-only mode for both voice and data.
- ❑ Be backward-compatible with previous systems while incurring no performance degradation with either earlier or newer devices.
- ❑ Facilitate migration from current HSPA infrastructure to HSPA+ infrastructure.

HSPA improvements have continued through successive 3GPP releases, including Release 14, which has downlink interference mitigation. Release 15 has work items for quality of experience, multi-carrier enhancements, and various protocol enhancements.

The following sections discuss specific enhancements that have already been implemented in HSPA.

Advanced Receivers

3GPP has specified a number advanced-received designs including: Type 1, which uses mobile-receive diversity; Type 2, which uses channel equalization; and Type 3, which includes a combination of receive diversity and channel equalization. Type 3i devices, which became available in 2012, employ interference cancellation. Note that the different types of receivers are release-independent. For example, Type 3i receivers will work and provide a capacity gain in an earlier Release 5 network.

The first approach is mobile-receive diversity. This technique relies on the optimal combination of received signals from separate receiving antennas. The antenna spacing yields signals that have somewhat independent fading characteristics. Hence, the combined signal can be more effectively decoded, which almost doubles downlink capacity when done in combination with channel equalization. Receive diversity is effective even with smaller devices such as like PC Card modems and smartphones.

Current receiver architectures based on rake receivers are effective for speeds up to a few megabits per second. But at higher speeds, the combination of reduced symbol period and multipath interference results in Intersymbol Interference and diminishes rake receiver performance. This problem can be solved by advanced-receiver architectures with channel equalizers that yield additional capacity gains over HSDPA with receive diversity. Alternate advanced-receiver approaches include interference cancellation and generalized rake receivers (G-Rake). Different vendors are emphasizing different approaches. The performance requirements for advanced-receiver architectures, however, were specified in 3GPP Release 6. The combination of mobile-receive diversity and channel equalization (Type 3) is especially attractive, because it results in a large capacity gain independent of the radio channel.

What makes such enhancements attractive is that the networks do not require any changes other than increased capacity within the infrastructure to support the higher bandwidth. Moreover, the network can support a combination of devices including both earlier devices that do not include these enhancements and later devices that do. Device vendors can selectively apply these enhancements to their higher-end devices.

MIMO

Another standardized capability is MIMO, a technique that employs multiple transmit antennas and multiple receive antennas, often in combination with multiple radios and multiple parallel data streams. The most common use of the term “MIMO” applies to spatial multiplexing. The transmitter sends different data streams over each antenna. Whereas multipath is an impediment for other radio systems, MIMO—as illustrated in Figure 107—actually exploits multipath, relying on signals to travel across different uncorrelated communications paths. The multiple data paths effectively operate in parallel and, with appropriate decoding, in a multiplicative gain in throughput.

Figure 107: MIMO Using Multiple Paths to Boost Throughput and Capacity

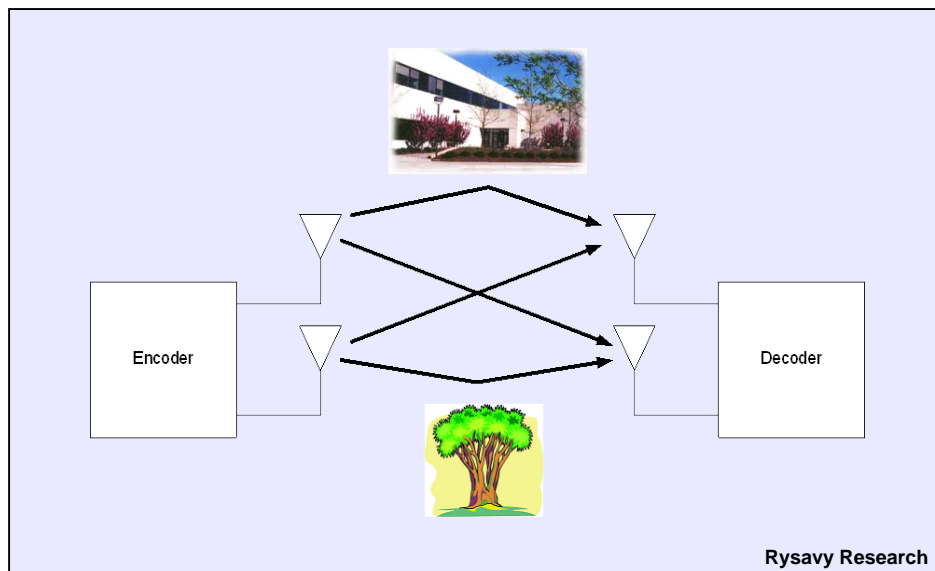

Tests of MIMO have proven effective in WLANs operating in relative isolation where interference is not a dominant factor. Spatial multiplexing MIMO can also benefit HSPA “hotspots” serving local areas including airports, campuses, and malls. In a fully loaded network with interference from adjacent cells, however, overall capacity gains will be more

modest—in the range of 20% to 33% over mobile-receive diversity. Relative to a 1x1 antenna system, however, 2X2 MIMO can deliver cell throughput gains of about 80%. 3GPP has standardized spatial multiplexing MIMO in Release 7 using Double Transmit Adaptive Array (D-TxAA).

Release 9 provides for a means to leverage MIMO antennas at the base station when transmitting to user equipment that does not support MIMO. The two transmit antennas in the base station can transmit a single stream using beam forming. This is called “single stream MIMO” or “MIMO with single-stream restriction” and results in higher throughput rates because of the improved signal received by the user equipment.

3GPP designed uplink dual-antenna beamforming and 2X2 MIMO for HSPA+ in Release 11.

Continuous Packet Connectivity

Continuous Packet Connectivity (CPC) specified in Release 7 reduces the uplink interference created by the dedicated physical control channels of packet data users when those channels have no user data to transmit, which increases the number of simultaneously connected HSUPA users. CPC allows both discontinuous uplink transmission and discontinuous downlink reception, wherein the modem can turn off its receiver after a certain period of HSDPA inactivity. CPC is especially beneficial to VoIP on the uplink because the radio can turn off between VoIP packets, as shown in Figure 108.

Figure 108: Continuous Packet Connectivity

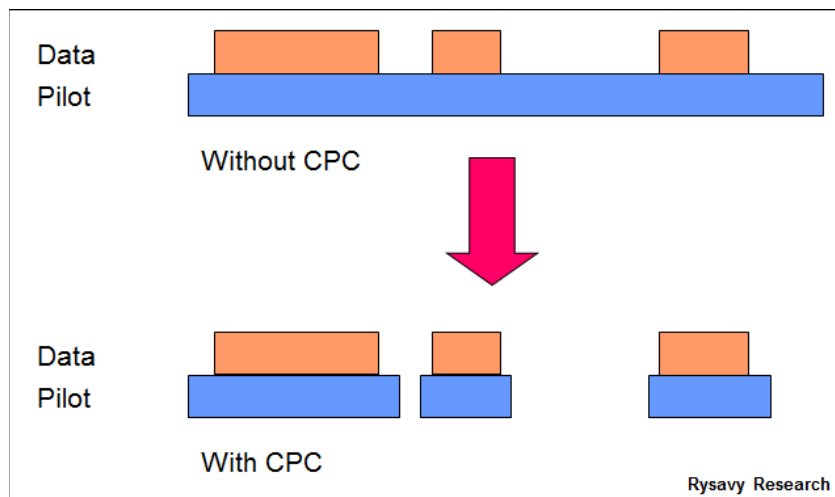

Higher Order Modulation

Another way of increasing performance is with higher order modulation. HSPA uses 16 QAM on the downlink and QPSK on the uplink, but HSPA+ adds 64 QAM to the downlink and 16 QAM to the uplink. 3GPP has also introduced 64 QAM to the uplink for HSPA+ in Release 11. Higher order modulation requires a better SNR, achieved through receive diversity and equalization.

Multi-Carrier HSPA

3GPP defined dual-carrier HSPA operation in Release 8, which coordinates the operation of HSPA on two adjacent 5 MHz carriers so that data transmissions can achieve higher

throughput rates, as shown in Figure 109. The work item assumed two adjacent carriers, downlink operation and no MIMO. This configuration achieves a doubling of the 21 Mbps maximum rate available on each channel to 42 Mbps.

Figure 109: Dual-Carrier Operation with One Uplink Carrier²⁰⁴

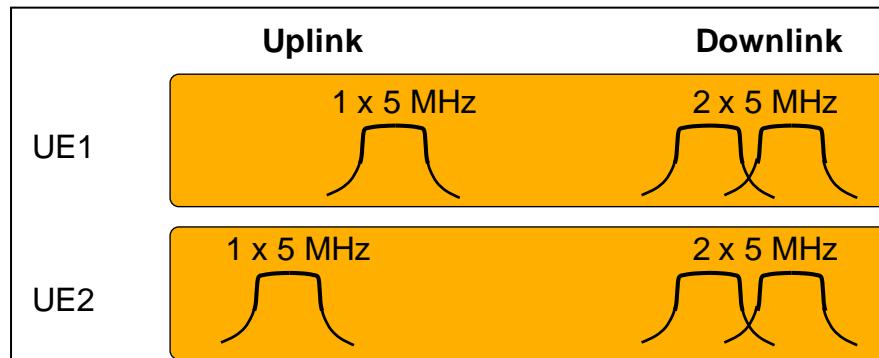

Benefits include:

- ❑ An increase in spectral efficiency of about 15%, comparable to what can be obtained with 2X2 MIMO.
- ❑ Significantly higher peak throughputs available to users, especially in lightly-loaded networks.
- ❑ Same maximum-throughput rate of 42 Mbps as using MIMO, but with a less expensive infrastructure upgrade.

Scheduling packets across two carriers is a more efficient use of resources, resulting in what is called “trunking gain.” Multi-user diversity also improves from an increased number of users across the two channels.

Release 9 also supports dual-carrier operation in the uplink. Release 10 specifies the use of up to four channels, resulting in peak downlink data rates of 168 Mbps. Release 11 supports eight radio channels on the downlink, resulting in a further doubling of theoretical throughput to 336 Mbps. On the uplink, devices can transmit using two antennas for either rank 1 (single stream beamforming) or rank 2 (dual-stream MIMO) transmission modes. Rank 1 beamforming helps with coverage (approximately 40%), while rank 2 MIMO helps with throughput speeds (approximately 20% median and 80% at cell edge). In addition, 64 QAM will be possible on the uplink, enabling uplink speeds to 69 Mbps in dual-carrier operation.

Downlink Multiflow Transmission

Release 11 specifies means by which two cells can transmit to the mobile station at the same time. The two cells transmit independent data, in effect a spatial multiplexing approach, improving both peak and average data.

²⁰⁴ Harri Holma and Antti Toskala, *LTE for UMTS, OFDMA and SC-FDMA Based Radio Access*, Wiley, April 2009.

Multiflow transmission with HSPA+ also enhances HetNet operation in which picocell coverage can be expanded within a macrocell coverage area, as shown in Figure 110.

Figure 110: HSPA+ HetNet Using Multipoint Transmission²⁰⁵

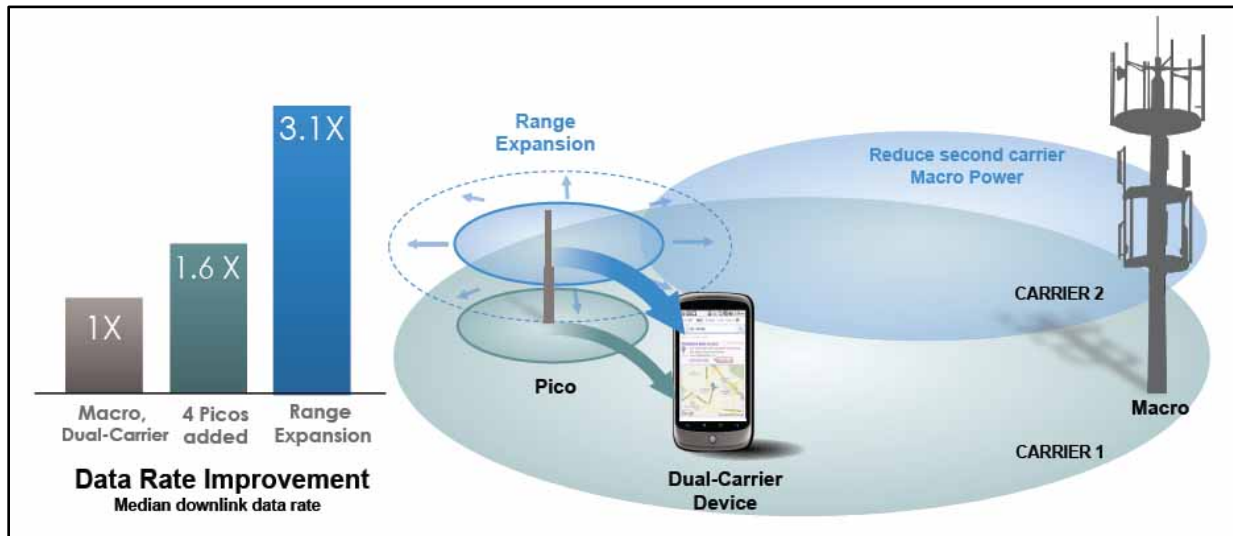

Multiflow enhances HSPA+ network operation using the following approaches:

- ❑ **Single Frequency Dual Cell.** The UE communicates with two different cells using the same frequency, improving cell-edge performance and providing network load balancing.
- ❑ **Dual Frequency Three Cell.** The UE communicates with two different cells using the same frequency. In addition, it communicates with one other cell on a different frequency.
- ❑ **Dual Frequency Four Cells.** The UE communicates using two instances of Single Frequency Dual Cell operation as described above.

In Release 12, 3GPP is considering the following enhancement to Multiflow operation, which is primarily targeted towards HetNet operation:

- ❑ **Dual Frequency Dual Carrier.** The UE aggregates cells on two different frequencies from two different sites.

HSPA+ Throughput Rates

Table 31 summarizes the capabilities of HSPA and HSPA+ based on the various methods discussed above.

²⁰⁵ Qualcomm, "HSPA+ Advanced: Taking HSPA+ to the Next Level," February 2012, <http://www.qualcomm.com/media/documents/hspa-advanced-taking-hspa-next-level-whitepaper>, accessed June 20, 2014.

Table 31: HSPA Throughput Evolution

Technology	Downlink (Mbps) Peak Data Rate	Uplink (Mbps) Peak Data Rate
HSPA as defined in Release 6	14.4	5.76
Release 7 HSPA+ DL 64 QAM, UL 16 QAM, 5+5 MHz	21.1	11.5
Release 7 HSPA+ 2X2 MIMO, DL 16 QAM, UL 16 QAM, 5+5 MHz	28.0	11.5
Release 8 HSPA+ 2X2 MIMO DL 64 QAM, UL 16 QAM, 5+5 MHz	42.2	11.5
Release 8 HSPA+ (no MIMO) Dual Carrier, 10+5 MHz	42.2	11.5
Release 9 HSPA+ 2X2 MIMO, Dual Carrier DL and UL, 10+10 MHz	84.0	23.0
Release 10 HSPA+ 2X2 MIMO, Quad Carrier ²⁰⁶ DL, Dual Carrier UL, 20+10 MHz	168.0	23.0
Release 11 HSPA+ 2X2 MIMO DL and UL, 8 Carrier DL, Dual Carrier UL, 40+10 MHz	336.0	69.0

Release 13 enables aggregation of two UL carriers across bands.

Figure 111 shows the cumulative distribution function of throughput values in a commercially deployed Release 8 HSPA+ network in an indoor coverage scenario. The figure shows significant performance gains from higher-order modulation and MIMO.

²⁰⁶ No operators have announced plans to deploy HSPA in a quad (or greater) carrier configuration. Three carrier configurations, however, have been deployed.

Figure 111: HSPA+ Performance Measurements Commercial Network (5+5 MHz)²⁰⁷

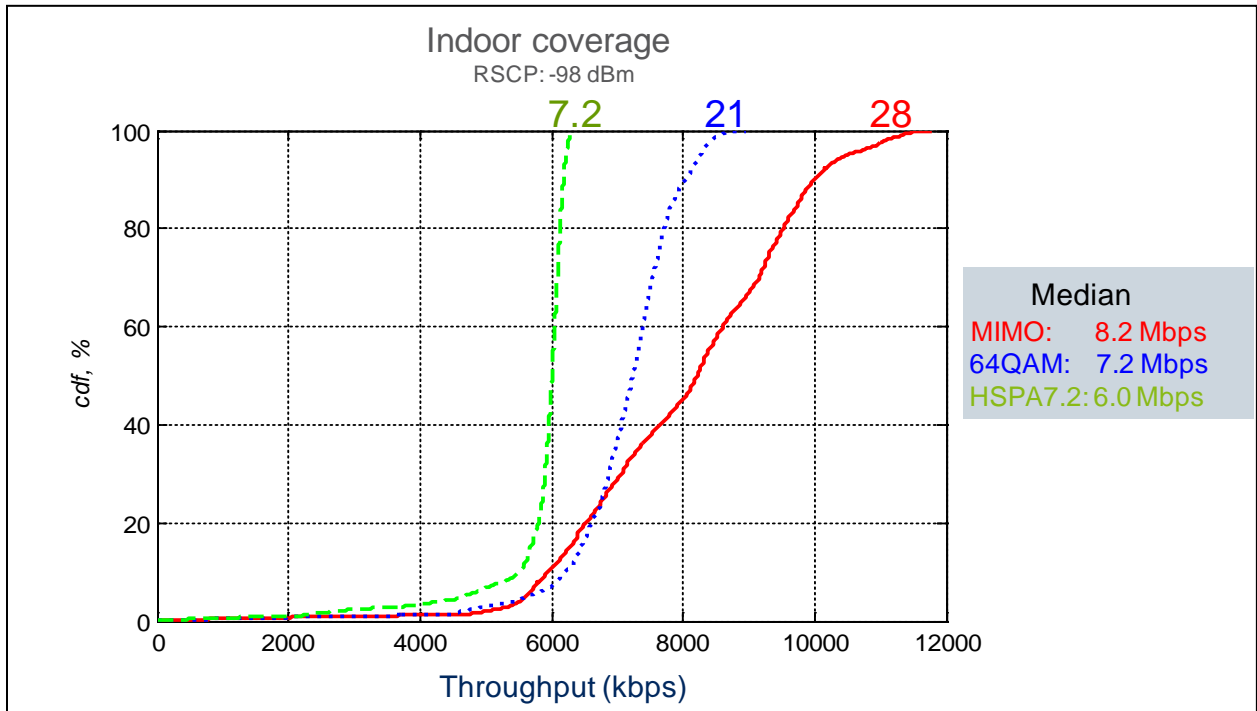

The figure shows a reasonably typical indoor scenario in a macro-cell deployment. Under better radio conditions, HSPA+ will achieve higher performance results.

Figure 112 shows the benefit of dual-carrier operation (no MIMO employed), which essentially doubles throughputs over single carrier operation.

²⁰⁷ 5G Americas member company contribution.

Figure 112: Dual-Carrier HSPA+ Throughputs²⁰⁸

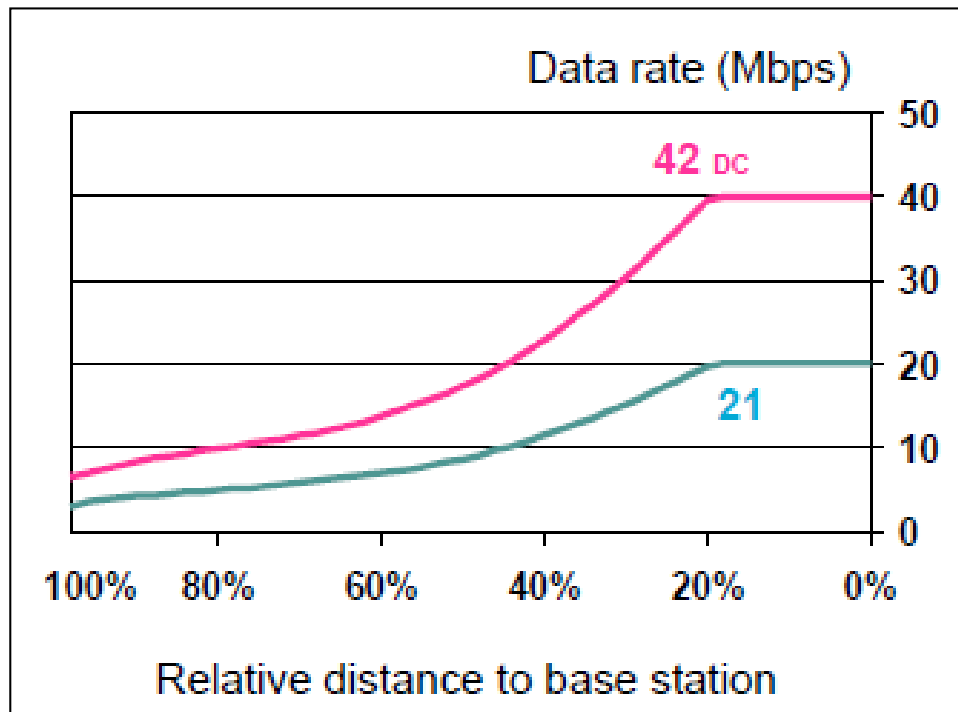

HSPA+ also has improved latency performance of as low as 25 msec and improved packet call setup time of below 500 msec.

Figure 113 summarizes the key capabilities and benefits of the features being deployed in HSPA+.

²⁰⁸ 5G Americas member company contribution. 64 QAM.

Figure 113: Summary of HSPA Functions and Benefits²⁰⁹

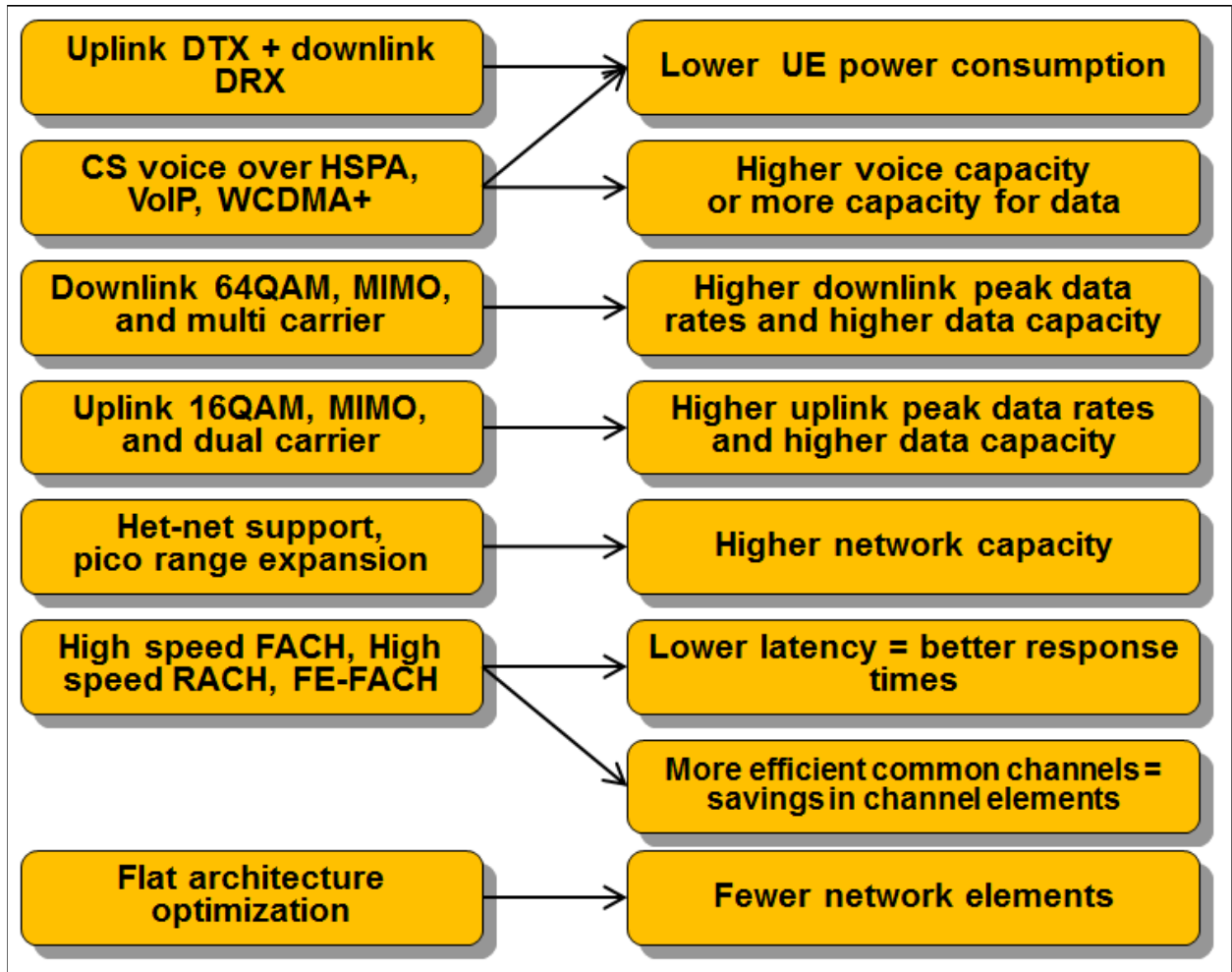

UMTS TDD and TD-SCDMA

Most WCDMA and HSDPA deployments are based on FDD, which uses different radio bands for transmit and receive. In the alternate TDD approach, transmit and receive functions alternate in time on the same radio channel. 3GPP specifications include a TDD version of UMTS, called “UMTS TDD.”

TDD does not provide any inherent advantage for voice functions, which need balanced links—namely, the same amount of capacity in both the uplink and the downlink. Many data applications, however, are asymmetric, often with the downlink consuming more bandwidth than the uplink. A TDD radio interface can dynamically adjust the downlink-to-uplink ratio accordingly, hence balancing both forward-link and reverse-link capacity. Note that for UMTS FDD, the higher spectral efficiency achievable in the downlink versus the uplink addresses the asymmetrical nature of average data traffic.

²⁰⁹ 5G Americas member contribution.

The UMTS TDD specification also includes the capability to use joint detection in receiver-signal processing, which offers improved performance.

One consideration, however, relates to available spectrum. Various countries around the world including those in Europe, Asia, and the Pacific region have licensed spectrum available specifically for TDD systems. TDD is also a good choice for any spectrum that does not provide a duplex gap between forward and reverse links.

In the United States, there is limited spectrum specifically allocated for TDD systems, the major band being BRS at 2.5 GHz used by Clearwire for WiMAX and now LTE TDD.²¹⁰ UMTS TDD is not a good choice in FDD bands; it would not be able to operate effectively in both bands, thereby making the overall system efficiency relatively poor.

TDD systems require network synchronization and careful coordination between operators or guardbands, which may be problematic in certain bands.

There has not been widespread deployment of UMTS TDD.

Time Division Synchronous Code Division Multiple Access (TD-SCDMA) is one of the official 3G wireless technologies, mostly for deployment in China. Specified through 3GPP as a variant of the UMTS TDD System and operating with a 1.28 megachips per second (Mcps) chip rate versus 3.84 Mcps for UMTS TDD, TD-SCDMA's primary attribute is that it supports very high subscriber densities, making it a possible alternative for wireless local loops. TD-SCDMA uses the same core network as UMTS, and it is possible for the same core network to support both UMTS and TD-SCDMA radio-access networks.

Although there are no planned deployments in any country other than China, TD-SCDMA could theoretically be deployed anywhere unpaired spectrum is available—such as the bands licensed for UMTS TDD—assuming appropriate resolution of regulatory issues.

EDGE/EGPRS

Today, most GSM networks support EDGE, an enhancement to GPRS, which is the original packet data service for GSM networks.²¹¹ GPRS provides a packet-based IP connectivity solution supporting a wide range of enterprise and consumer applications. GSM networks with EDGE operate as wireless extensions to the internet and give users internet access, as well as access to their organizations from anywhere. Peak EDGE user-achievable²¹² throughput rates are up to 200 Kbps. Figure depicts the system architecture.

²¹⁰ The 1910-1920 MHz band targeted unlicensed TDD systems but has never been used.

²¹¹ GSM technology also provides circuit-switched data services, which are not described in this paper since they are seldom used.

²¹² "Peak user-achievable" means users, under favorable conditions of network loading and signal propagation, can achieve this rate as measured by applications such as file transfer. Average rates depend on many factors and will be lower than these rates.

Figure 114: GSM/GPRS/EDGE Architecture

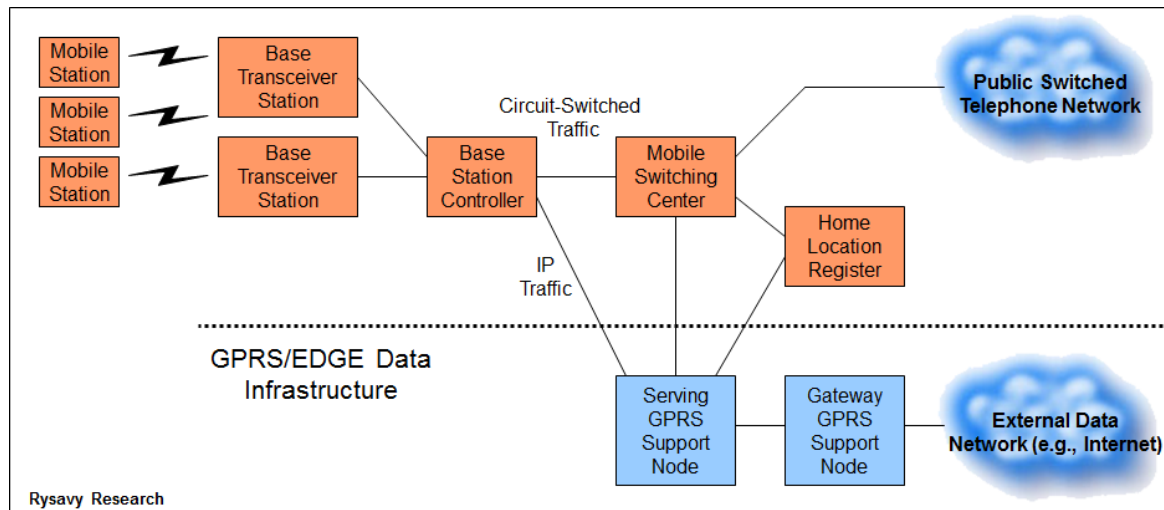

EDGE is essentially the addition of a packet-data infrastructure to GSM. In fact, this same data architecture is preserved in UMTS and HSPA networks, and the data architecture is technically referred to as GPRS for the core-data function in all of these networks. The term GPRS may also be used to refer to the initial radio interface, now supplanted by EDGE. Functions of the data elements are as follows:

- ❑ The base station controller directs/receives packet data to/from the Serving GPRS Support Node (SGSN), an element that authenticates and tracks the location of mobile stations.
- ❑ The SGSN performs the types of functions for data that the Mobile Switching Center (MSC) performs for voice. Each serving area has one SGSN, and it is often collocated with the MSC.
- ❑ The SGSN forwards/receives user data to/from the Gateway GPRS Support Node (GGSN), which can be viewed as a mobile IP router to external IP networks. Typically, there is one GGSN per external network (for example, the internet). The GGSN also manages IP addresses, dynamically assigning them to mobile stations for their data sessions.

Another important element is the Home Location Register (HLR), which stores users' account information for both voice and data services. Of significance is that this same data architecture supports data services in GSM and in UMTS-HSPA networks, thereby simplifying operator network upgrades.

In the radio link, GSM uses radio channels of 200 kilohertz (kHz) width, divided in time into eight timeslots comprising 577 microseconds (μs) that repeat every 4.6 msec, as shown in Figure . The network can have multiple radio channels (referred to as transceivers) operating in each cell sector. The network assigns different functions to each timeslot such as the Broadcast Control Channel (BCCH), circuit-switched functions like voice calls or data calls, the optional Packet Broadcast Control Channel (PBCCH), and packet data channels. The network can dynamically adjust capacity between voice and data functions, and it can also reserve minimum resources for each service. This scheduling approach enables more data traffic when voice traffic is low or, likewise, more voice traffic when data traffic is low, thereby maximizing overall use of the network. For example, the PBCCH, which expands

the capabilities of the normal BCCH, may be set-up on an additional timeslot of a Time Division Multiple Access (TDMA) frame when justified by the volume of data traffic.

Figure 115: Example of GSM/EDGE Timeslot Structure²¹³

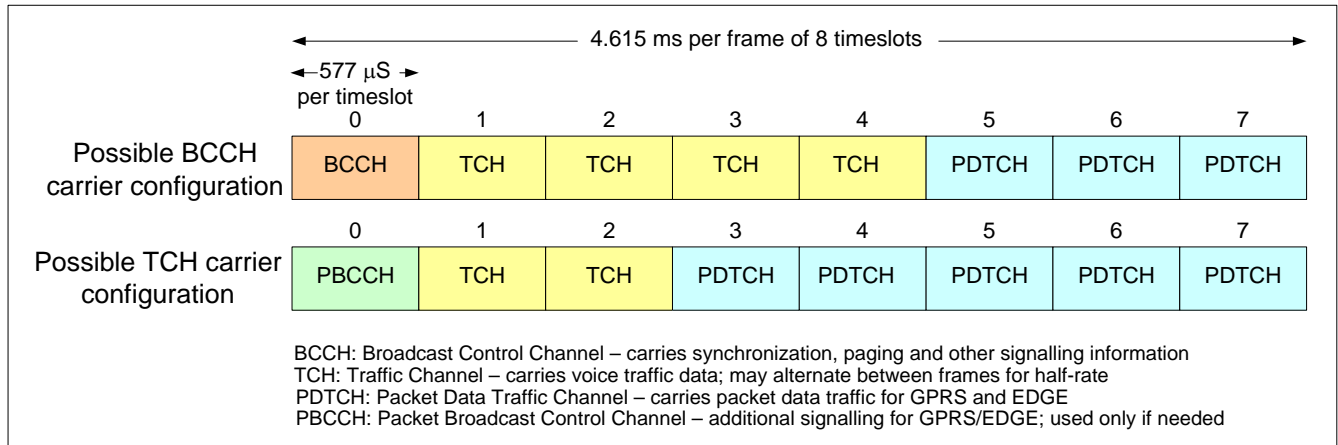

EDGE offers close coupling between voice and data services. In most networks, while in a data session, users can accept an incoming voice call, which suspends the data session, and then resume their data session automatically when the voice session ends. Users can also receive SMS messages and data notifications²¹⁴ while on a voice call, as described below.

With respect to data performance, each data timeslot can deliver peak user-achievable data rates of up to about 40 Kbps. The network can aggregate up to five timeslots on the downlink and up to four timeslots on the uplink with current devices.

If multiple data users are active in a sector, they share the available data channels. As demand for data services increases, however, an operator can accommodate customers by assigning an increasing number of channels for data service that is limited only by that operator’s total available spectrum and radio planning.

EDGE is an official 3G cellular technology that can be deployed within an operator's existing 850, 900, 1800, and 1900 MHz spectrum bands. EDGE capability is now largely standard in new GSM deployments. A GPRS network using the EDGE radio interface is technically called an “Enhanced GPRS” (EGPRS) network, and a GSM network with EDGE capability is referred to as GSM Edge Radio Access Network (GERAN). EDGE has been an inherent part of GSM specifications since Release 99. It is fully backward-compatible with older GSM networks, meaning that GPRS devices work on EDGE networks and that GPRS and EDGE terminals can operate simultaneously on the same traffic channels.

Dual Transfer Mode (DTM) devices can simultaneously communicate voice and data. DTM is a 3GPP-specified technology that enables new applications like video sharing while providing a consistent service experience (service continuity) with UMTS. Typically, a DTM

²¹³ 5G Americas member company contribution.

²¹⁴ Example: WAP notification message delivered via SMS.

end-to-end solution requires only a software upgrade to the GSM/EDGE radio network. There are a number of networks and devices supporting DTM.

A feature in Release 9 that applies to EDGE is the Enhanced Flexible Timeslot Assignment (EFTA), which allows for more efficient adaptation to varying uplink versus downlink transmission needs. The network allocates uplink and downlink timeslots that overlap in time, and the mobile station may either use the corresponding uplink timeslots for transmission or receive on the overlapping downlink time slot, if it has nothing to transmit. In addition, alternative EFTA multi-slot classes enable the support of as many as eight timeslots per downlink carrier (instead of five or six timeslots with multi-slot classes 30 to 45).

Abbreviations and Acronyms

The following abbreviations are used in this paper. Abbreviations are defined on first use.

1G – First Generation

1xEV-DO – One Carrier Evolution, Data Optimized

1xEV-DV – One Carrier Evolution, Data Voice

1XRTT – One Carrier Radio Transmission Technology

2G – Second Generation

3G – Third Generation (meeting requirements set forth by the ITU IMT project)

3GPP – Third Generation Partnership Project

3GPP2 – Third Generation Partnership Project 2

4G – Fourth Generation (meeting requirements set forth by the ITU IMT-Advanced project)

5GC – 5G Core

8-PSK – Octagonal Phase Shift Keying

AAS – Adaptive Antenna Systems

ABR – Allocation Retention Priority

AGW – Access Gateway

AMF – Access and Mobility Management Function

AMR – Adaptive Multi Rate

AMR-WB – Adaptive Multi-Rate Wideband

ANDSF – Access Network Discovery and Selection Function.

ANSI – American National Standards Institute

APCO – Association of Public Safety Officials

API – Application Programming Interface

APN – Access Point Name

ARP – Allocation Retention Priority

ARPU – Average Revenue per User

ARQ – Automatic Repeat Request

ATM – Asynchronous Transfer Mode

AWGN – Additive White Gaussian Noise Channel

AWS – Advanced Wireless Services

BCCH – Broadcast Control Channel

bps – bits per second

BRS – Broadband Radio Service

BSC – Base Station Controller

BTS – Base Transceiver Station

C/I – Carrier to Intermodulation Ratio

CAPEX- Capital Expenditure

CBF – Coordinated Beam Forming

CBRS – Citizens Broadband Radio Service

CBS – Coordinated Beam Switching
CSS3 – Cascading Style Sheets 3 (CSS3)
CDD – Cyclic Delay Diversity
CDF – Cumulative Distribution Function
CDMA – Code Division Multiple Access
CL – Closed Loop
CL-SM – Closed Loop Spatial Multiplexing
CMAS – Commercial Mobile Alert System
CMOS – Complementary Metal Oxide Semiconductor
CoMP – Coordinated Multi Point
cMTC – Critical Machine Type Communications
CP – Cyclic Prefix
CPC – Continuous Packet Connectivity
CPRI – Common Public Radio Interface
CQI - Channel Quality Indicators
C-RAN – Cloud Radio Access Network
CRM – Customer Relationship Management
CRS – Cell-specific Reference Signal
CS – Convergence Sublayer
CSFB – Circuit-Switched Fallback
CTIA – Cellular Telephone Industries Association
C-V2X – Cellular Vehicle-to-X
D-AMPS – Digital Advanced Mobile Phone Service
DAS – Distributed Antenna System
DAS – Downlink EGPRS2-A Level Scheme
dB – Decibel
DBS – Downlink EGPRS2-B Level Scheme
DC-HSPA – Dual Carrier HSPA
DFT – Discrete Fourier Transform
DL – Downlink
DNS – Domain Name Service
DPCCH – Dedicated Physical Control Channel
DPS – Dynamic Point Selection
DSL – Digital Subscriber Line
DSMIPv6 – Dual Stack Mobile IPv6
DTM – Dual Transfer Mode
DRX – Discontinuous Reception
D-TxAA – Double Transmit Adaptive Array
DVB-H – Digital Video Broadcasting Handheld

E-DCH – Enhanced Dedicated Channel
EBCMCS – Enhanced Broadcast Multicast Services
EC-GSM – Extended Coverage GSM
eCoMP – enhanced CoMP
EDGE – Enhanced Data Rates for GSM Evolution
EFTA – Enhanced Flexible Timeslot Assignment
EGPRS – Enhanced General Packet Radio Service
eICIC – Enhanced Inter-Cell Interference Coordination
eMBMS – Enhanced Multimedia Broadcast Multicast Services
eNodeB – Evolved Node B
EAP – Extensible Authentication Protocol
eLAA – Enhanced Licensed-Assisted Access
eNB – Evolved Node B
EPC – Evolved Packet Core
EPDCCH – Enhanced Physical Downlink Control Channel
eMBB – Enhanced Mobile Broadband
ePDG – Enhanced Packet Data Gateway
EPS – Evolved Packet System
ERP – Enterprise Resource Planning
eSaMOG – Enhanced S2a-based Mobility over GTP
ESC – Environmental Sensing Capability
eSRVCC – Enhanced Single-Radio Voice Call Continuity
ETRI – Electronic and Telecommunications Research Institute
ETSI – European Telecommunications Standards Institute
E-UTRAN – Enhanced UMTS Terrestrial Radio Access Network
EVS – Enhanced Voice Services (codec)
FE-FACH – Further Enhanced Forward Access Channel
EV-DO – Evolution, Data Optimized
EV-DV – Evolution, Data Voice
EVRG – Enhanced Variable Rate Codec
FBMC – Filter-Bank Multi-Carrier
FCC – Federal Communications Commission
FDD – Frequency Division Duplex
FeCoMP – Further Enhanced Coordinated Multi Point
feICIC – Further enhanced ICIC
FirstNet – First Responder Network Authority
Flash OFDM – Fast Low-Latency Access with Seamless Handoff OFDM
FLO – Forward-Link Only
FMC – Fixed Mobile Convergence

FP7 – Seventh Framework Programme
FTP – File Transfer Protocol
GAA – General Authorized Access
GAN – Generic Access Network
GB – Gigabyte
Gbps – Gigabits Per Second
GBR – Guaranteed Bit Rate
GByte – Gigabyte
GCS – Group Communication Service
GERAN – GSM EDGE Radio Access Network
GFDM – Generalized Frequency Division Multiplexing
GGSN – Gateway GPRS Support Node
GHz – Gigahertz
GMSK – Gaussian Minimum Shift Keying
gNB – NR NodeB
GPRS – General Packet Radio Service
G-Rake – Generalized Rake Receiver
GSM – Global System for Mobile Communications
GSMA – GSM Association
HARQ – Hybrid Automatic Repeat Request
HD – High Definition
HetNet – heterogeneous network
HLR – Home Location Register
Hr – Hour
HSDPA – High Speed Downlink Packet Access
HS-FACH – High Speed Forward Access Channel
HS-PDSCH - High Speed Physical Downlink Shared Channels
HS-RACH – High Speed Reverse Access Channel
HSPA – High Speed Packet Access (HSDPA with HSUPA)
HSPA+ – HSPA Evolution
HSS – Home Subscriber Server
HSUPA – High Speed Uplink Packet Access
Hz – Hertz
ICIC – Inter-Cell Interference Coordination
ICN – Information-Centric Networking
ICS – IMS Centralized Services
ICT – Information and Communication Technologies
IEEE – Institute of Electrical and Electronic Engineers
IETF – Internet Engineering Taskforce

IFFT – Inverse Fast Fourier Transform
IFOM – IP Flow and Seamless Offload
IM – Instant Messaging
IMS – IP Multimedia Subsystem
IMT – International Mobile Telecommunications
IMT-Advanced - International Mobile Telecommunications-Advanced
IRC – Interference Rejection Combining
IoT – Internet of Things
IPR - Intellectual Property Rights
IP – Internet Protocol
IPTV – Internet Protocol Television
IR – Incremental Redundancy
ISD – Inter-site Distance
ISI – Intersymbol Interference
ISP – Internet Service Provider
ITU – International Telecommunication Union
JCP – Java Community Process
JR – Joint Reception
JT – Joint Transmission
Kbps – Kilobits Per Second
kHz — Kilohertz
km – Kilometer
LAA – License-Assisted Access
LBT – Listen-Before-Talk
LDPC - Low-Density Parity Code
LIPA – Local IP Access
LMDS – Local Multipoint Distribution Service
LPWA – Low-Power Wide-Area
LTE – Long Term Evolution
LTE-A – LTE-Advanced
LTE-TDD – LTE Time Division Duplex
LTE-U – LTE-Unlicensed
LSTI – LTE/SAE Trial Initiative
LWA – LTE Wi-Fi Aggregation
LWIP – LTE WLAN Radio Level Integration with IPsec Tunnel
M2M – Machine-to-machine
MAC – Medium-Access Control
MAPCON – Multi-Access PDN Connectivity
MB - Megabyte

MBMS - Multimedia Broadcast/Multicast Service
Mbps – Megabits Per Second
MBR – Maximum Bit Rate
MBSFN – Multicast/broadcast, Single Frequency
MCPA – Mobile Consumer Application Platform
Mcps – Megachips Per Second
MCPTT – Mission-Critical Push-to-Talk
MCS – Modulation and Coding Scheme
MCW – Multiple Codeword
MDT – Minimization of Drive Tests
MEAP – Mobile Enterprise Application Platforms
MEC – Multi-access Edge Computing
MediaFLO – Media Forward Link Only
METIS – Mobile and wireless communications Enablers for the Twenty-twenty Information Society
MHz – Megahertz
MID – Mobile Internet Devices
MIMO – Multiple Input Multiple Output
MMSE – Minimum Mean Square Error
mITF – Japan Mobile IT Forum
MMDS – Multichannel Multipoint Distribution Service
MME – Mobile Management Entity
mMTC – Massive Machine Type Communications
MOS – Mean Opinion Score
MP-QUIC – Multipath Quick UDP Internet Connections
MP-TCP – Multipath TCP
MRxD – Mobile Receive Diversity
ms – millisecond
MS – Mobile Station
MSA – Mobile Service Architecture
MSC – Mobile Switching Center
MTC – Machine Type Communications
MTC-IWF – Machine-Type Communications Interworking Function (MTC-IWF)
msec – millisecond
MU-MIMO – Multi-User MIMO
MUST – Downlink Multiuser Superposition Transmission
NAICS – Network-Assisted Interference Cancellation and Suppression
NB-IoT – Narrowband Internet of Things
NENA – National Emergency Number Association
NGMC – Next Generation Mobile Committee

NGMN – Next Generation Mobile Networks Alliance
NG-RAN – New Generation Radio Access Network
NOMA – Non-Orthogonal Multiple Access
NR – New Radio
NTIA – National Telecommunications and Information Administration
OFDM – Orthogonal Frequency Division Multiplexing
OFDMA – Orthogonal Frequency Division Multiple Access
OL-SM – Open Loop Spatial Multiplexing
OMA – Open Mobile Alliance
ORI – Open Radio Equipment Interface
PA – Priority Access
PAL – Priority Access License
PAR – Peak to Average Ratio
PBCCH – Packet Broadcast Control Channel
PCH – Paging Channel
PCRF – Policy Control and Charging Rules Function
PCS – Personal Communications Service
PDCP – Packet Data Convergence Protocol
PDN – Packet Data Network
PGW – Packet Gateway
PHY – Physical Layer
PMI – Precoding Matrix Indication
PMIPv6 – Proxy Mobile IPv6
PNF – Physical Network Function
PoC – Push-to-Talk Over Cellular
PSH – Packet Switched Handover
PSK – Phase-Shift Keying
QAM – Quadrature Amplitude Modulation
QCI – Quality of Service Class Identifier
QLIC – Quasi-Linear Interference Cancellation
QoS – Quality of Service
QPSK – Quadrature Phase Shift Keying
QUIC – Quick UDP Internet Connections.
RAB – Radio Access Bearer
RAN – Radio Access Network
RCAF – RAN Congestion Awareness Function
RCLWI - RAN Controlled LTE WLAN Interworking
RCS – Rich Communications Suite
REST – Representational State Transfer

RF – Radio Frequency
RLC – Radio Link Control
RNC – Radio Network Controller
ROHC – Robust Header Compression
RRC – Radio Resource Control
RRH – Remote Radio Head
RRU – Remote Radio Unit
RTP – Real Time Transport Protocol
RTSP – Real Time Streaming Protocol
SAE – System Architecture Evolution
SaMOG – S2a-based Mobility over GTP
SAS – Spectrum Access System
SC-FDMA – Single Carrier Frequency Division Multiple Access
SCMA – Sparse Coded Multiple Access
SCRI – Signaling Connection Release Indication
SCW – Single Codeword
SDAP – Service Data Adaptation Protocol
SDMA – Space Division Multiple Access
SDN – Software-Defined Networking
SDP – Session Description Protocol
sec – Second
SFBA – Space Frequency Block Code
SFN – Single Frequency Network
SGSN – Serving GPRS Support Node
SGW – Serving Gateway
SIC – Successive Interference Cancellation
SIM – Subscriber Identity Module
SIMO – Single Input Multiple Output
SINR – Signal to Interference Plus Noise Ratio
SIP – Session Initiation Protocol
SIPTO – Selected IP Traffic Offload
SISO – Single Input Single Output
SMS – Short Message Service
SNR – Signal to Noise Ratio
SON – Self-Organizing Network
SPS – Semi-Persistent Scheduling
SRVCC – Single-Radio Voice Call Continuity
SU-MIMO – Single User MIMO
SVDO – Simultaneous 1XRTT Voice and EV-DO Data

SVLTE – Simultaneous Voice and LTE
TCH – Traffic Channel
TCP/IP – Transmission Control Protocol/IP
TD – Transmit Diversity
TDD – Time Division Duplex
TDMA – Time Division Multiple Access
TD-SCDMA – Time Division Synchronous Code Division Multiple Access
TD-CDMA – Time Division Code Division Multiple Access
TETRA – Terrestrial Trunked Radio
TIA/EIA – Telecommunications Industry Association/Electronics Industry Association
TISPAN – Telecoms and Internet Converged Services and Protocols for Advanced Networks
TSG-RAN – Technical Services Group Radio Access Network
TTI – Transmission Time Interval
UAS – Uplink EGPRS2-A Level Scheme
UBS – Uplink EGPRS2-B Level Scheme
UE – User Equipment
UFMC – Universal Filtered Multi-Carrier
UICC – Universal Integrated Circuit Card
UL – Uplink
UMA – Unlicensed Mobile Access
UMB – Ultra Mobile Broadband
UMTS – Universal Mobile Telecommunications System
UPCON – User-Plane Congestion Management
UPF – User Plane Function
URA-PCH – UTRAN Registration Area Paging Channel
URI – Uniform Resource Identifier
URLLC – Ultra-Reliable and Low Latency Communications
us – Microsecond
USIM – UICC SIM
UTRAN – UMTS Terrestrial Radio Access Network
V2X – vehicle -to-infrastructure
VAMOS – Voice Services over Adaptive Multi-User Channels on One Slot
VDSL – Very-High-Bit-Rate DSL
VEPC – Virtualized EPC
ViLTE – Video Over LTE
VoIP – Voice over Internet Protocol
VoHSPA – Voice over HSPA
VoLGA – Voice over LTE Generic Access
VoLTE – Voice over LTE

VNF- Virtual Network Function
VPN – Virtual Private Network
WAP – Wireless Application Protocol
WBA – Wireless Broadband Alliance
WCDMA – Wideband Code Division Multiple Access
WCS – Wireless Communication Service
WebRTC – Web Real-Time Communication
Wi-Fi – Wireless Fidelity
WiMAX – Worldwide Interoperability for Microwave Access
WLAN – Wireless Local Area Network
WMAN – Wireless Metropolitan Area Network
WMM – Wi-Fi Multimedia
WRC – World Radiocommunication Conference

Additional Information

5G Americas maintains market information, LTE deployment lists, and numerous white papers, available for free download on its web site: <http://www.5gamericas.org>.

If there are any questions regarding the download of this information, please call +1 425 372 8922 or e-mail Anushka Bishen, Public Relations Coordinator at info@5gamericas.org.

This white paper was written for 5G Americas by Rysavy Research (<http://www.rysavy.com>) and utilized a composite of statistical information from multiple resources.

The contents of this paper reflect the independent research, analysis, and conclusions of Rysavy Research and may not necessarily represent the comprehensive opinions and individual viewpoints of each particular 5G Americas Board member company.

Rysavy Research provides this document and the information contained herein to you for informational purposes only. Rysavy Research provides this information solely on the basis that you will take responsibility for making your own assessments of the information.

Although Rysavy Research has exercised reasonable care in providing this information to you, Rysavy Research does not warrant that the information is error-free. Rysavy Research disclaims and in no event shall be liable for any losses or damages of any kind, whether direct, indirect, incidental, consequential, or punitive arising out of or in any way related to the use of the information.

Copyright © 2017 Rysavy Research, LLC. All rights reserved.

<http://www.rysavy.com>